



ORANGE COLLECTION

N/E EURO Exklusiv MwSt

ORANGE COLLECTION

PREISLISTE 03.2023

PREISLISTE 03.2023

N/E EURO Exklusiv MwSt

ALLGEMEINE INFORMATIONEN

PREISE

Die Preise verstehen sich in **EURO** ohne MwSt, siehe Deckblatt.

VERKAUFSPREISE

Frei Haus Verzollt (DDP).

GÜLTIGKEIT

Diese Liste ersetzt alle vorherigen Preislisten. Sie wird bis zum Widerruf gültig sein.

AUFBAU DER PREISLISTE

Jedes Modell hat seine Preisliste.

Im oberen Bereich der Preisliste befindet sich der Kopfteil mit den technischen Zeichnungen der Grundausführung und den wichtigsten Informationen über das Modell (*Bezug abziehbar, Unterteilung der Bezüge, verfügbare Optionen, FüÙe, usw.*).

Für jeden Artikel eines Modells enthält die Preisliste folgende Angaben:

- Die technischen Zeichnungen mit Maßangabe und Artikelcode unter der Zeichnung.

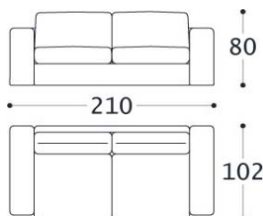

1MN2D2

- Die Artikelbeschreibung.

Die Beschreibung des einzelnen Artikels (z.B. Zweisitzer-Sofa) oder der Artikel einer Wohnlandschaft (z.B. 1 Zweisitzer-Sofa mit Armlehne links + 1 Chaiselongue mit Armlehne rechts).

- Artikelcodes und Kategorien

Die Codes der einzelnen Artikel mit Stoffbezug beginnen mit der Ziffer 1 (z.B. 1MN2D2). Die Codes der Wohnlandschaften mit Stoffbezug beginnen mit den Ziffern 01 (z.B. 01MN2C1). Die Codes der einzelnen Artikel mit Lederbezug beginnen mit der Ziffer 2 (z.B. 2MN2D2). Die Codes der Wohnlandschaften mit Lederbezug beginnen mit den Ziffern 02 (z.B. 02MN2C1).

Die Preise für einen Artikel mit Stoffbezug und mit Lederbezug sind in zwei Tabellen nebeneinander angegeben.

Die Preise für Artikel mit Stoffbezug haben Kategorien in Zahlen, die Preise für Artikel mit Lederbezug haben Kategorien in Buchstaben.

Die Stoffkategorien gehen von Kat. 3 (vom Kunden gelieferter Stoff) bis Kat. 13.

Die Lederkategorien gehen von Kat. E bis Kat. M.

VOM KUNDEN GELIEFERTE STOFFE

Auf Anfrage stellen wir Artikel mit Stoffen her, die vom Kunden geliefert werden. In diesem Fall gilt der Preis der Kat. 3 (falls nicht anders angegeben). Die Machbarkeit wird für jede einzelne Anfrage von uns geprüft. Obligatorisch für die Verarbeitung ist eine Stoffbreite von 140 cm (ohne Webkante).

STOFF UND LEDER

Die Stoff – und Lederpreise pro Meter verstehen sich AB WERK.

FÜR DIE REINIGUNG UND WARTUNG DER LEDERSOFAS

Die Preise für Lederreinigungsset verstehen sich AB WERK.

Code 4406 Leder-Reinigungsset € 25,00

Bestehend aus:

- Leather soft cleaner (Reiniger)
- Leather protection cream (Schutzcreme)

Code 4407 Leder- Reinigungsset € 30,00

Bestehend aus:

- Leather soft cleaner (Reiniger)
- Leather protection cream (Schutzcreme)
- Ink away (Set für das Entfernen von Tintenflecken)

Code 4408 Nubuk- Reinigungsset € 50,00

Bestehend aus:

- Leather soft cleaner (Reiniger)
- Leather protection cream (Schutzcreme)

Die Bestellungen können an die E-mail Adresse export@alberta.it oder an die Faxnummer +390438441555 gesendet werden.

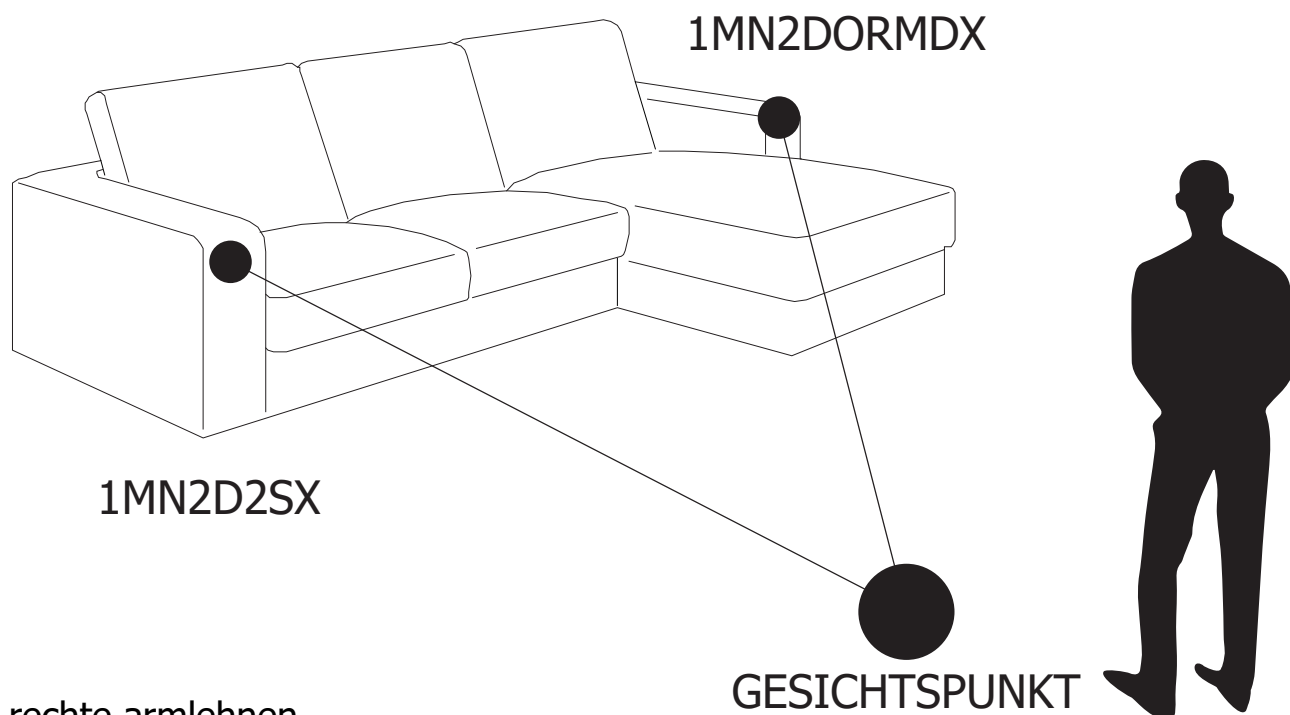

DX: rechte armlehnen

SX: linke armlehnen

RECHTE UND LINKE ARMLEHNEN

Bei seitenelementen und bei Eckkombinationen versteht man sich dass die Position der Armlehnen rechts (dx) oder links (sx). Jedes Sofas von vorne muss betrachtet werden.

NORMALERWEISE SIND DIE SKIZZE DER SEITENELEMENTE IN DER PREISLISTE LINKS.

STAHLFEDERN

Das Foto zeigt einen Ausschnitt des Sofas mit Stahlfedern ("Nosag") bestückt.



Modelle mit Stahlfedern sind mit diesem Symbol gekennzeichnet



Die anderen Modelle haben elastischen Gurten.

INHALT

■ ALBERT 1	pag. 1	■ THEO	pag. 138
■ ALCAZAR	pag. 2	■ THEO SLIM	pag. 150
■ ARGO	pag. 10	■ TOGO	pag. 162
■ BELLAVITA NEW	pag. 16	■ VEGA	pag. 169
■ BROADWAY 2	pag. 28	■ VEGA 2	pag. 176
■ CECILE	pag. 48	■ MORBIDOSO	pag. 178
■ COLLINS 2	pag. 51	■ 99	pag. 180
■ ELLE	pag. 59	■ STOFF/LEDER	pag. 186
■ FRISCO	pag. 61		
■ GOSSIP	pag. 63		
■ HONOLULU	pag. 65		
■ ISLAND	pag. 67		
■ JAGGER	pag. 69		
■ JAMMIN	pag. 70		
■ JIMMY 3	pag. 72		
■ KALINDA	pag. 74		
■ MANHATTAN 2	pag. 76		
■ METROPOLIS	pag. 95		
■ PHIL	pag. 101		
■ PITAGORA	pag. 102		
■ SPACE	pag. 111		
■ SUMMER	pag. 116		
■ SUNSET	pag. 132		

07 S74 N/E D. ORANGE 03.2023

TOP- Auswahl (Marmor): Mar.NATURAL DOVER WHITE (X1), Mar.MAGIC BROWN (X1), Mar.Arabesque Purple (X1), Mar.DAINO REALE (X2), Mar.MARQUINA BLACK (X2), Mar.EMPERADOR BROWN (X3), Mar.NATURAL TRAVERTINO (X3), Mar.CALACATTA WHITE (X4), Mar.VERDE ISSORIE (X4), Mar.CREAM CALACATTA (X4). BASIS AUS MASSIVHOLZ NUSSBAUM CANALETTO.

	<p>RECHTECKIGER COUCHTISCH 130X80 H.35</p>	<table border="1"> <thead> <tr> <th colspan="2">1AL1TAVR</th> </tr> </thead> <tbody> <tr> <td>X1</td> <td>3.749,00</td> </tr> <tr> <td>X2</td> <td>2.717,00</td> </tr> <tr> <td>X3</td> <td>3.026,00</td> </tr> <tr> <td>X4</td> <td>3.688,00</td> </tr> </tbody> </table>	1AL1TAVR		X1	3.749,00	X2	2.717,00	X3	3.026,00	X4	3.688,00
1AL1TAVR												
X1	3.749,00											
X2	2.717,00											
X3	3.026,00											
X4	3.688,00											
	<p>OVALER TISCH 130X80 H.35</p>	<table border="1"> <thead> <tr> <th colspan="2">1AL1TAVOV</th> </tr> </thead> <tbody> <tr> <td>X1</td> <td>3.987,00</td> </tr> <tr> <td>X2</td> <td>2.717,00</td> </tr> <tr> <td>X3</td> <td>3.264,00</td> </tr> <tr> <td>X4</td> <td>3.688,00</td> </tr> </tbody> </table>	1AL1TAVOV		X1	3.987,00	X2	2.717,00	X3	3.264,00	X4	3.688,00
1AL1TAVOV												
X1	3.987,00											
X2	2.717,00											
X3	3.264,00											
X4	3.688,00											
	<p>QUADRATISCHER TISCH 120X120 H.35</p>	<table border="1"> <thead> <tr> <th colspan="2">1AL1TAVQ</th> </tr> </thead> <tbody> <tr> <td>X1</td> <td>4.465,00</td> </tr> <tr> <td>X2</td> <td>3.089,00</td> </tr> <tr> <td>X3</td> <td>3.341,00</td> </tr> <tr> <td>X4</td> <td>4.374,00</td> </tr> </tbody> </table>	1AL1TAVQ		X1	4.465,00	X2	3.089,00	X3	3.341,00	X4	4.374,00
1AL1TAVQ												
X1	4.465,00											
X2	3.089,00											
X3	3.341,00											
X4	4.374,00											
	<p>QUADRATISCHER TISCH 75X75 H.50</p>	<table border="1"> <thead> <tr> <th colspan="2">1AL1TAVQ75</th> </tr> </thead> <tbody> <tr> <td>X1</td> <td>2.561,00</td> </tr> <tr> <td>X2</td> <td>1.959,00</td> </tr> <tr> <td>X3</td> <td>2.171,00</td> </tr> <tr> <td>X4</td> <td>2.477,00</td> </tr> </tbody> </table>	1AL1TAVQ75		X1	2.561,00	X2	1.959,00	X3	2.171,00	X4	2.477,00
1AL1TAVQ75												
X1	2.561,00											
X2	1.959,00											
X3	2.171,00											
X4	2.477,00											
	<p>QUADRATISCHER TISCH 50X50 H.50</p>	<table border="1"> <thead> <tr> <th colspan="2">1AL1TAVQ50</th> </tr> </thead> <tbody> <tr> <td>X1</td> <td>1.893,00</td> </tr> <tr> <td>X2</td> <td>1.497,00</td> </tr> <tr> <td>X3</td> <td>1.718,00</td> </tr> <tr> <td>X4</td> <td>1.700,00</td> </tr> </tbody> </table>	1AL1TAVQ50		X1	1.893,00	X2	1.497,00	X3	1.718,00	X4	1.700,00
1AL1TAVQ50												
X1	1.893,00											
X2	1.497,00											
X3	1.718,00											
X4	1.700,00											
	<p>RUNDERER TISCH Ø50 H.50</p>	<table border="1"> <thead> <tr> <th colspan="2">1AL1TROT50</th> </tr> </thead> <tbody> <tr> <td>X1</td> <td>2.012,00</td> </tr> <tr> <td>X2</td> <td>1.497,00</td> </tr> <tr> <td>X3</td> <td>1.742,00</td> </tr> <tr> <td>X4</td> <td>1.700,00</td> </tr> </tbody> </table>	1AL1TROT50		X1	2.012,00	X2	1.497,00	X3	1.742,00	X4	1.700,00
1AL1TROT50												
X1	2.012,00											
X2	1.497,00											
X3	1.742,00											
X4	1.700,00											

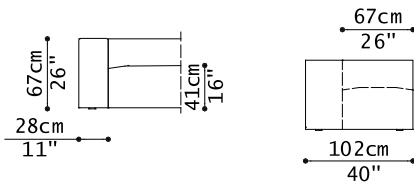

07 S74 N/E D. ORANGE 03.2023

DIE STOFF-VERSION IST ABNEHMBAR UND MAN KANN DIESES MODELL NUR MIT EINEM EINZELNEN STOFF BEZIEHEN. GESTREIFTE STOFFE ODER STOFFE MIT MUSTERN EIGNEN SICH NICHT FÜR DIESES MODELL. KEDER AUS RIBSBAND-GROSGRAIN WAHLFREI(SIEHE GROSGRAIN-MUSTER) ODER NAHT IM DENSELBEIN STOFF UND FARBE DES ELEMENTS. WENN DIE BORTE MIT GROSGRAIN IST, EMPFEHLEN WIR DIE BEZÜGE TROCKENZUREINIGEN. VERFÜGBAR AUCH AUS KUNSTLEDER (NICHT ABNEHMBAR).

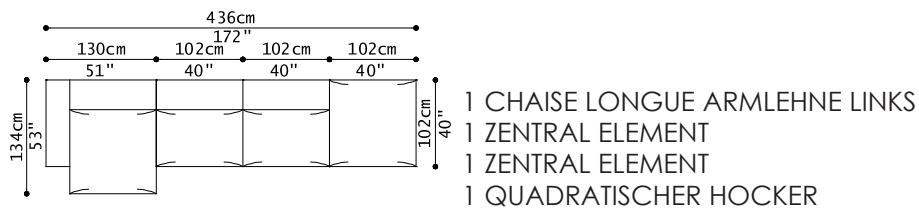

01ALZC1

- 1 CHAISE LONGUE ARMLEHNE LINKS
- 1 ZENTRAL ELEMENT
- 1 ZENTRAL ELEMENT
- 1 QUADRATISCHER HOCKER

01ALZC1		02ALZC1	
Cat.3	5.022,00	Cat.E	6.214,00
Cat.4	5.241,00	Cat.F	7.451,00
Cat.5	5.404,00	Cat.G	8.019,00
Cat.6	5.567,00	Cat.H	8.843,00
Cat.7	5.785,00	Cat.I	10.444,00
Cat.8	6.004,00	Cat.L	11.165,00
Cat.9	6.657,00	Cat.M	12.091,00
Cat.10	7.093,00		
Cat.11	7.583,00		
Cat.12	8.075,00		
Cat.13	8.674,00		

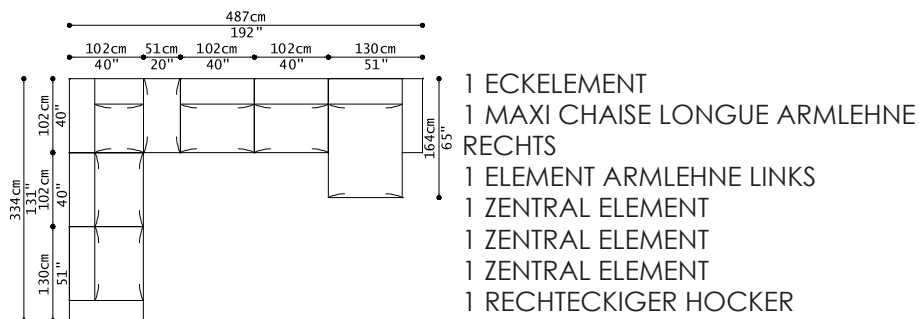

01ALZC2

- 1 ECKELEMENT
- 1 MAXI CHAISE LONGUE ARMLEHNE RECHTS
- 1 ELEMENT ARMLEHNE LINKS
- 1 ZENTRAL ELEMENT
- 1 ZENTRAL ELEMENT
- 1 ZENTRAL ELEMENT
- 1 RECHTECKIGER HOCKER

01ALZC2		02ALZC2	
Cat.3	9.096,00	Cat.E	11.408,00
Cat.4	9.495,00	Cat.F	13.677,00
Cat.5	9.792,00	Cat.G	14.717,00
Cat.6	10.091,00	Cat.H	16.227,00
Cat.7	10.489,00	Cat.I	19.161,00
Cat.8	10.888,00	Cat.L	20.483,00
Cat.9	12.079,00	Cat.M	22.182,00
Cat.10	12.873,00		
Cat.11	13.768,00		
Cat.12	14.664,00		
Cat.13	15.757,00		

07 S74 N/E D. ORANGE 03.2023

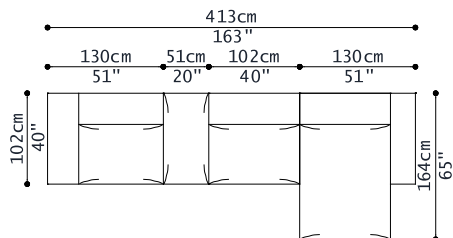

01ALZC3

- 1 MAXI CHAISE LONGUE ARMLEHNE RECHTS
- 1 ELEMENT ARMLEHNE LINKS
- 1 ZENTRAL ELEMENT
- 1 RECHTECKIGER HOCKER

01ALZC3	
Cat.3	5.563,00
Cat.4	5.798,00
Cat.5	5.973,00
Cat.6	6.150,00
Cat.7	6.384,00
Cat.8	6.619,00
Cat.9	7.321,00
Cat.10	7.789,00
Cat.11	8.316,00
Cat.12	8.844,00
Cat.13	9.488,00

02ALZC3	
Cat.E	6.878,00
Cat.F	8.220,00
Cat.G	8.835,00
Cat.H	9.729,00
Cat.I	11.464,00
Cat.L	12.246,00
Cat.M	13.252,00

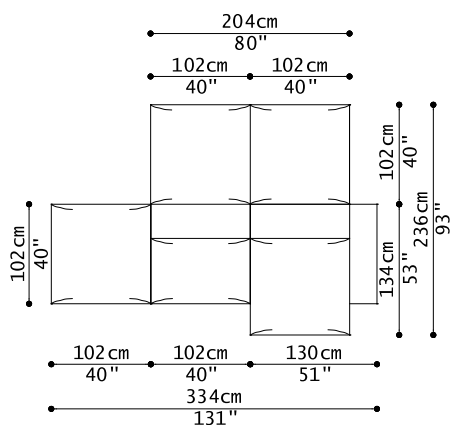

01ALZC4

- 1 CHAISE LONGUE ARMLEHNE RECHTS
- 1 ZENTRAL ELEMENT
- 3 QUADRATISCHER HOCKER

01ALZC4	
Cat.3	5.827,00
Cat.4	6.076,00
Cat.5	6.262,00
Cat.6	6.448,00
Cat.7	6.694,00
Cat.8	6.943,00
Cat.9	7.685,00
Cat.10	8.182,00
Cat.11	8.738,00
Cat.12	9.298,00
Cat.13	9.978,00

02ALZC4	
Cat.E	7.122,00
Cat.F	8.490,00
Cat.G	9.119,00
Cat.H	10.032,00
Cat.I	11.803,00
Cat.L	12.600,00
Cat.M	13.626,00

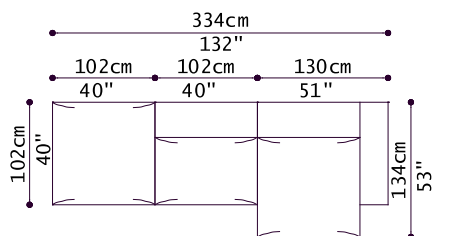

01ALZC6

- 1 CHAISE LONGUE ARMLEHNE RECHTS
- 1 ZENTRAL ELEMENT
- 1 QUADRATISCHER HOCKER

01ALZC6	
Cat.3	3.899,00
Cat.4	4.068,00
Cat.5	4.194,00
Cat.6	4.320,00
Cat.7	4.488,00
Cat.8	4.657,00
Cat.9	5.161,00
Cat.10	5.498,00
Cat.11	5.876,00
Cat.12	6.256,00
Cat.13	6.718,00

02ALZC6	
Cat.E	4.822,00
Cat.F	5.778,00
Cat.G	6.217,00
Cat.H	6.854,00
Cat.I	8.091,00
Cat.L	8.648,00
Cat.M	9.364,00

07 S74 N/E D. ORANGE 03.2023

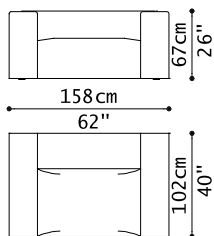

1ALZE

ELEMENT MIT ZWEI ARMLEHNEN

1ALZE		2ALZE	
Cat.3	1.921,00	Cat.E	2.477,00
Cat.4	2.018,00	Cat.F	3.031,00
Cat.5	2.091,00	Cat.G	3.285,00
Cat.6	2.164,00	Cat.H	3.654,00
Cat.7	2.261,00	Cat.I	4.369,00
Cat.8	2.359,00	Cat.L	4.692,00
Cat.9	2.650,00	Cat.M	5.108,00
Cat.10	2.845,00		
Cat.11	3.064,00		
Cat.12	3.283,00		
Cat.13	3.550,00		

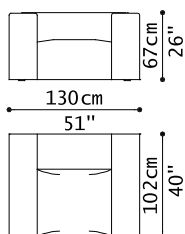

1ALZES

SMALL ELEMENT MIT ZWEI ARMLEHNEN

1ALZES		2ALZES	
Cat.3	1.763,00	Cat.E	2.264,00
Cat.4	1.849,00	Cat.F	2.754,00
Cat.5	1.913,00	Cat.G	2.979,00
Cat.6	1.978,00	Cat.H	3.305,00
Cat.7	2.064,00	Cat.I	3.938,00
Cat.8	2.150,00	Cat.L	4.224,00
Cat.9	2.407,00	Cat.M	4.591,00
Cat.10	2.579,00		
Cat.11	2.772,00		
Cat.12	2.966,00		
Cat.13	3.202,00		

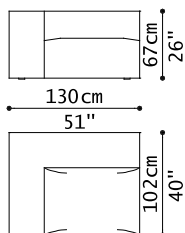

1ALZESX

ELEMENT ARMLEHNE LINKS
ELEMENT ARMLEHNE RECHTS

1ALZESX		2ALZESX	
1ALZEDX		2ALZEDX	
Cat.3	1.535,00	Cat.E	1.946,00
Cat.4	1.610,00	Cat.F	2.364,00
Cat.5	1.666,00	Cat.G	2.555,00
Cat.6	1.722,00	Cat.H	2.834,00
Cat.7	1.796,00	Cat.I	3.373,00
Cat.8	1.871,00	Cat.L	3.616,00
Cat.9	2.095,00	Cat.M	3.930,00
Cat.10	2.244,00		
Cat.11	2.411,00		
Cat.12	2.579,00		
Cat.13	2.784,00		

07 S74 N/E D. ORANGE 03.2023

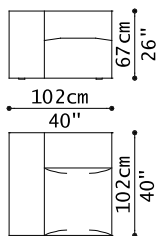

1ALZESSX

SMALL ELEMENT ARMLEHNE LINKS
SMALL ELEMENT ARMLEHNE RECHTS

1ALZESSX		2ALZESSX	
1ALZESDX		2ALZESDX	
Cat.3	1.388,00	Cat.E	1.735,00
Cat.4	1.456,00	Cat.F	2.089,00
Cat.5	1.507,00	Cat.G	2.251,00
Cat.6	1.558,00	Cat.H	2.487,00
Cat.7	1.626,00	Cat.I	2.943,00
Cat.8	1.694,00	Cat.L	3.150,00
Cat.9	1.899,00	Cat.M	3.415,00
Cat.10	2.035,00		
Cat.11	2.189,00		
Cat.12	2.342,00		
Cat.13	2.529,00		

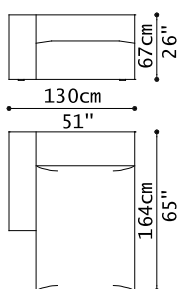

1ALZCHLMSX

MAXI CHAISE LONGUE ARMLEHNE LINKS
MAXI CHAISE LONGUE ARMLEHNE
RECHTS

1ALZCHLMSX		2ALZCHLMSX	
1ALZCHLMDX		2ALZCHLMDX	
Cat.3	2.182,00	Cat.E	2.704,00
Cat.4	2.265,00	Cat.F	3.224,00
Cat.5	2.327,00	Cat.G	3.462,00
Cat.6	2.390,00	Cat.H	3.808,00
Cat.7	2.473,00	Cat.I	4.480,00
Cat.8	2.556,00	Cat.L	4.783,00
Cat.9	2.805,00	Cat.M	5.173,00
Cat.10	2.971,00		
Cat.11	3.158,00		
Cat.12	3.345,00		
Cat.13	3.573,00		

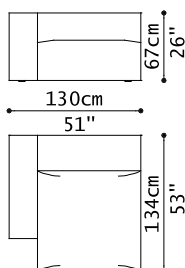

1ALZCHLSX

CHAISE LONGUE ARMLEHNE LINKS
CHAISE LONGUE ARMLEHNE RECHTS

1ALZCHLSX		2ALZCHLSX	
1ALZCHLDX		2ALZCHLDX	
Cat.3	1.812,00	Cat.E	2.280,00
Cat.4	1.891,00	Cat.F	2.749,00
Cat.5	1.950,00	Cat.G	2.964,00
Cat.6	2.009,00	Cat.H	3.276,00
Cat.7	2.088,00	Cat.I	3.882,00
Cat.8	2.167,00	Cat.L	4.155,00
Cat.9	2.403,00	Cat.M	4.506,00
Cat.10	2.561,00		
Cat.11	2.738,00		
Cat.12	2.916,00		
Cat.13	3.132,00		

07 S74 N/E D. ORANGE 03.2023

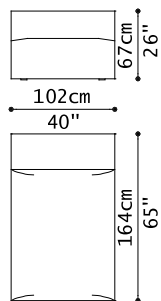

1ALZCHLM1

ZENTRAL MAXI CHAISE LONGUE

1ALZCHLM1		2ALZCHLM1	
Cat.3	1.762,00	Cat.E	2.145,00
Cat.4	1.820,00	Cat.F	2.528,00
Cat.5	1.864,00	Cat.G	2.704,00
Cat.6	1.907,00	Cat.H	2.960,00
Cat.7	1.966,00	Cat.I	3.455,00
Cat.8	2.024,00	Cat.L	3.678,00
Cat.9	2.199,00	Cat.M	3.966,00
Cat.10	2.315,00		
Cat.11	2.446,00		
Cat.12	2.577,00		
Cat.13	2.737,00		

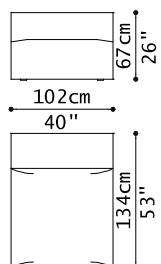

1ALZCHL1

ZENTRAL CHAISE LONGUE

1ALZCHL1		2ALZCHL1	
Cat.3	1.394,00	Cat.E	1.722,00
Cat.4	1.448,00	Cat.F	2.054,00
Cat.5	1.489,00	Cat.G	2.206,00
Cat.6	1.529,00	Cat.H	2.428,00
Cat.7	1.583,00	Cat.I	2.857,00
Cat.8	1.637,00	Cat.L	3.051,00
Cat.9	1.799,00	Cat.M	3.300,00
Cat.10	1.907,00		
Cat.11	2.028,00		
Cat.12	2.150,00		
Cat.13	2.298,00		

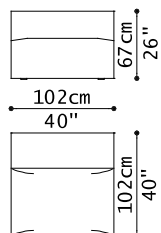

1ALZE1

ZENTRAL ELEMENT

1ALZE1		2ALZE1	
Cat.3	1.123,00	Cat.E	1.392,00
Cat.4	1.173,00	Cat.F	1.673,00
Cat.5	1.210,00	Cat.G	1.802,00
Cat.6	1.247,00	Cat.H	1.989,00
Cat.7	1.297,00	Cat.I	2.353,00
Cat.8	1.347,00	Cat.L	2.517,00
Cat.9	1.496,00	Cat.M	2.727,00
Cat.10	1.595,00		
Cat.11	1.707,00		
Cat.12	1.819,00		
Cat.13	1.956,00		

07 S74 N/E D. ORANGE 03.2023

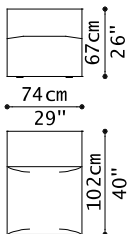

ZENTRAL SMALL ELEMENT

1ALZES1

1ALZES1		2ALZES1	
Cat.3	978,00	Cat.E	1.174,00
Cat.4	1.027,00	Cat.F	1.391,00
Cat.5	1.064,00	Cat.G	1.491,00
Cat.6	1.101,00	Cat.H	1.636,00
Cat.7	1.150,00	Cat.I	1.916,00
Cat.8	1.199,00	Cat.L	2.043,00
Cat.9	1.346,00	Cat.M	2.206,00
Cat.10	1.444,00		
Cat.11	1.554,00		
Cat.12	1.664,00		
Cat.13	1.799,00		

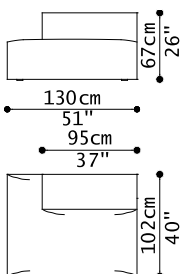

ENDELEMENT LINKS
ENDELEMENT RECHTS

1ALZTRSX

1ALZTRSX		2ALZTRSX	
1ALZTRDX		2ALZTRDX	
Cat.3	1.660,00	Cat.E	1.886,00
Cat.4	1.714,00	Cat.F	2.161,00
Cat.5	1.755,00	Cat.G	2.287,00
Cat.6	1.796,00	Cat.H	2.470,00
Cat.7	1.851,00	Cat.I	2.825,00
Cat.8	1.906,00	Cat.L	2.985,00
Cat.9	2.070,00	Cat.M	3.191,00
Cat.10	2.179,00		
Cat.11	2.302,00		
Cat.12	2.425,00		
Cat.13	2.575,00		

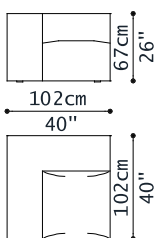

ECKELEMENT

1ALZAR

1ALZAR		2ALZAR	
Cat.3	1.287,00	Cat.E	1.746,00
Cat.4	1.351,00	Cat.F	2.111,00
Cat.5	1.399,00	Cat.G	2.278,00
Cat.6	1.447,00	Cat.H	2.520,00
Cat.7	1.511,00	Cat.I	2.991,00
Cat.8	1.575,00	Cat.L	3.203,00
Cat.9	1.766,00	Cat.M	3.476,00
Cat.10	1.894,00		
Cat.11	2.038,00		
Cat.12	2.182,00		
Cat.13	2.357,00		

07 S74 N/E D. ORANGE 03.2023

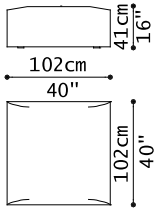

1ALZPFFQ

QUADRATISCHER HOCKER

1ALZPFFQ		2ALZPFFQ	
Cat.3	964,00	Cat.E	1.150,00
Cat.4	1.004,00	Cat.F	1.356,00
Cat.5	1.034,00	Cat.G	1.451,00
Cat.6	1.064,00	Cat.H	1.589,00
Cat.7	1.103,00	Cat.I	1.856,00
Cat.8	1.143,00	Cat.L	1.976,00
Cat.9	1.262,00	Cat.M	2.131,00
Cat.10	1.342,00		
Cat.11	1.431,00		
Cat.12	1.521,00		
Cat.13	1.630,00		

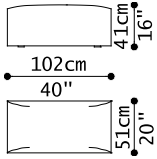

1ALZPFFR

RECHTECKIGER HOCKER

1ALZPFFR		2ALZPFFR	
Cat.3	723,00	Cat.E	836,00
Cat.4	750,00	Cat.F	959,00
Cat.5	770,00	Cat.G	1.016,00
Cat.6	791,00	Cat.H	1.098,00
Cat.7	818,00	Cat.I	1.258,00
Cat.8	845,00	Cat.L	1.330,00
Cat.9	925,00	Cat.M	1.422,00
Cat.10	979,00		
Cat.11	1.040,00		
Cat.12	1.101,00		
Cat.13	1.175,00		

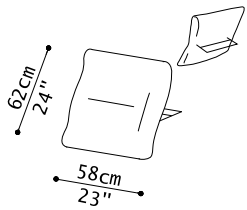

1ALZCSS

KISSEN SPECIAL

1ALZCSS		2ALZCSS	
Cat.3	325,00	Cat.E	377,00
Cat.4	349,00	Cat.F	454,00
Cat.5	367,00	Cat.G	489,00
Cat.6	386,00	Cat.H	540,00
Cat.7	410,00	Cat.I	639,00
Cat.8	434,00	Cat.L	684,00
Cat.9	506,00	Cat.M	741,00
Cat.10	555,00		
Cat.11	609,00		
Cat.12	663,00		
Cat.13	730,00		

07 S74 N/E D. ORANGE 03.2023

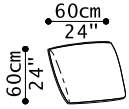

1ALZCQ60P

QUADRATISCHER KISSEN 60X60 CM AUS FEDER

1ALZCQ60P		2ALZCQ60P	
Cat.3	97,00	Cat.E	157,00
Cat.4	111,00	Cat.F	227,00
Cat.5	122,00	Cat.G	259,00
Cat.6	132,00	Cat.H	306,00
Cat.7	147,00	Cat.I	397,00
Cat.8	161,00	Cat.L	438,00
Cat.9	203,00	Cat.M	491,00
Cat.10	232,00		
Cat.11	264,00		
Cat.12	296,00		
Cat.13	335,00		

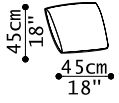

1ALZCQ45

QUADRATISCHER KISSEN AUS FEDER 45X45 CM

1ALZCQ45		2ALZCQ45	
Cat.3	83,00	Cat.E	121,00
Cat.4	92,00	Cat.F	164,00
Cat.5	100,00	Cat.G	183,00
Cat.6	107,00	Cat.H	212,00
Cat.7	117,00	Cat.I	267,00
Cat.8	127,00	Cat.L	292,00
Cat.9	157,00	Cat.M	324,00
Cat.10	177,00		
Cat.11	199,00		
Cat.12	222,00		
Cat.13	249,00		

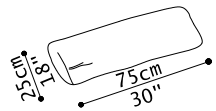

1ALZPR

NIERENKISSEN

1ALZPR		2ALZPR	
Cat.3	97,00	Cat.E	116,00
Cat.4	112,00	Cat.F	150,00
Cat.5	122,00	Cat.G	166,00
Cat.6	133,00	Cat.H	188,00
Cat.7	147,00	Cat.I	232,00
Cat.8	161,00	Cat.L	252,00
Cat.9	204,00	Cat.M	278,00
Cat.10	232,00		
Cat.11	264,00		
Cat.12	296,00		
Cat.13	335,00		

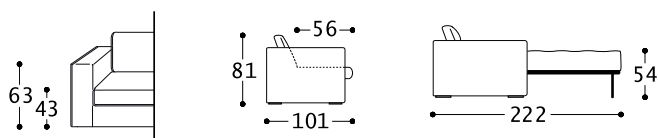

07 S74 N/E D. ORANGE 03.2023

BEZÜGE SIND ABNEHMBAR. DIESES MODELL KANN MIT UNTERSCHIEDLICHEN STOFFE FÜR RÜCK-SITZKISSEN UND CHASSIS BEZOGEN WERDEN. SITZKISSEN UND RÜCKENKISSEN WERDEN MIT DEM SELBEN STOFF BEZOGEN. GESTREIFTE STOFFE ODER STOFFE MIT MUSTERN EIGNEN SICH NUR FÜR RÜCKENKISSEN. KEDER AUS RIBSBAND-GROSGRAIN WAHLFREI (SIEHE GROSGRAIN-MUSTER) ODER BORTE IN DEMSELBEN STOFF UND FARBE DES ELEMENTS. WENN DIE BORTE MIT GROSGRAIN IST, EMPFEHELEN WIR DIE BEZÜGE TROCKENZUREINIGEN. LIEFERBAR AUCH AUS KUNSTLEDER (NICHT ABNEHMBAR). SCHLAFSOFAS SIND MIT POLYURETHANSCHAUM MATRATZE GELIEFERT, H. 11 CM. AUF ANFRAGE KANN MAN AUCH MIT MATRATZE "LUX" MIT MEMORY-SCHAUM UND ABNEHMBAR STRETCH STOFF GELIEFERT WERDEN. DIES HAT FOLGENDE AUFSCHLÄGE AUF DER PREISLISTE: MA10053: 160X200X11 EUR.447,00 - MA10054: 140X200X11 EUR.389,00 - MA10055: 120X200X11 EUR.360,00 - MA10057: 75X200X11 EUR.245,00. AUF NACHFRAGE KANN SOFA/SESSEL MIT ZWEI ARMLEHNEN AUCH RAD-KIT VERSEHEN SEIN (KODE ME10171), MIT EINER ERHÖHUNG VON EUR.177,00 AUF DEN LISTENPREIS. DIE ELEMENTE MIT BETT WERDEN ZERLEGT GELIEFERT UND IN 3 KOLLI GETEILT: SOFA MIT LATTENROST, ARMLEHNEN, MATRATZE. DAS SOFA MIT LATTENROST UND DIE ARMLEHNEN WERDEN MIT KARTON VERPACKT. DIE MATRATZE WIRD MIT NYLON VERPACKT.

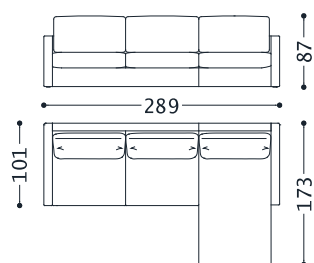

0ARGC1

1 RECHTE DORMEUSE MIT
BEHALTERKASTEN
1 ZWEI SITZER MAXI SOFA ARMLEHNE
LINKS MIT LATTENROST UND
POLYURETHANMATRATZE

0ARGC1

Cat.3	4.929,00
Cat.4	5.131,00
Cat.5	5.283,00
Cat.6	5.435,00
Cat.7	5.637,00
Cat.8	5.839,00
Cat.9	6.446,00
Cat.10	6.851,00
Cat.11	7.307,00
Cat.12	7.762,00
Cat.13	8.318,00

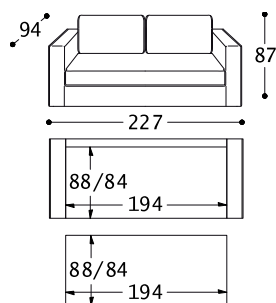

1ARGT3DP2

DREI SITZER SOFA MIT 2
ORTHOPÄDISCHEN LATTENROSTEN UND
POLYURETHANMATRATZE, H. 13 CM

1ARGT3DP2

Cat.3	3.240,00
Cat.4	3.375,00
Cat.5	3.476,00
Cat.6	3.577,00
Cat.7	3.712,00
Cat.8	3.847,00
Cat.9	4.252,00
Cat.10	4.522,00
Cat.11	4.825,00
Cat.12	5.129,00
Cat.13	5.500,00

07 S74 N/E D. ORANGE 03.2023

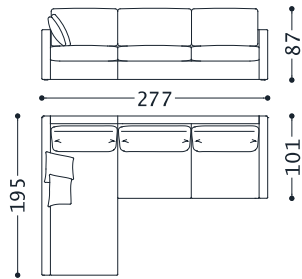

0ARGC2

1 ZWEI SITZER MAXI SOFA ARMLEHNE
RECHTS MIT LATTENROST UND
POLYURETHANMATRATZE
1 MERIDIENNE LINKS

0ARGC2	
Cat.3	4.876,00
Cat.4	5.109,00
Cat.5	5.284,00
Cat.6	5.459,00
Cat.7	5.692,00
Cat.8	5.924,00
Cat.9	6.623,00
Cat.10	7.088,00
Cat.11	7.613,00
Cat.12	8.137,00
Cat.13	8.777,00

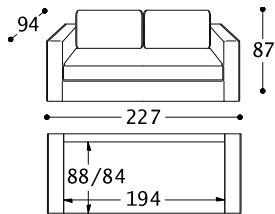

1ARGT3DP1

DREI SITZER SOFA MIT 1 ORTHOPÄDISCHE
LATTENROST UND
POLYURETHANMATRATZE, H. 13 CM

1ARGT3DP1	
Cat.3	2.482,00
Cat.4	2.617,00
Cat.5	2.718,00
Cat.6	2.819,00
Cat.7	2.954,00
Cat.8	3.089,00
Cat.9	3.494,00
Cat.10	3.764,00
Cat.11	4.067,00
Cat.12	4.371,00
Cat.13	4.742,00

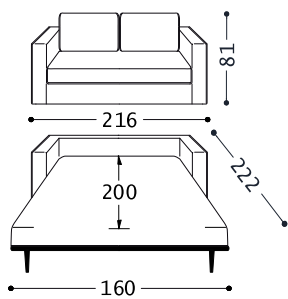

1ARGD3DP

DREI SITZER SOFA MIT LATTENROST UND
POLYURETHANMATRATZE

1ARGD3DP	
Cat.3	3.487,00
Cat.4	3.619,00
Cat.5	3.718,00
Cat.6	3.818,00
Cat.7	3.950,00
Cat.8	4.082,00
Cat.9	4.478,00
Cat.10	4.742,00
Cat.11	5.039,00
Cat.12	5.336,00
Cat.13	5.699,00

07 S74 N/E D. ORANGE 03.2023

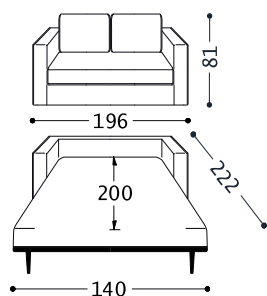

1ARGD2MDP

ZWEI SITZER MAXI SOFA MIT LATTENROST UND POLYURETHANMATRATZE

1ARGD2MDP

Cat.3	3.177,00
Cat.4	3.299,00
Cat.5	3.390,00
Cat.6	3.481,00
Cat.7	3.602,00
Cat.8	3.724,00
Cat.9	4.088,00
Cat.10	4.331,00
Cat.11	4.604,00
Cat.12	4.877,00
Cat.13	5.211,00

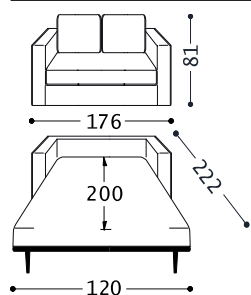

1ARGD2DP

ZWEI SITZER SOFA MIT LATTENROST UND POLYURETHANMATRATZE

1ARGD2DP

Cat.3	3.002,00
Cat.4	3.117,00
Cat.5	3.203,00
Cat.6	3.289,00
Cat.7	3.404,00
Cat.8	3.519,00
Cat.9	3.864,00
Cat.10	4.094,00
Cat.11	4.353,00
Cat.12	4.612,00
Cat.13	4.928,00

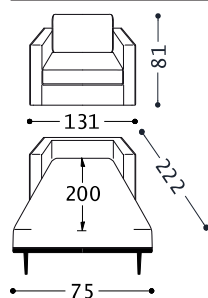

1ARGPDP

SESSEL MIT LATTENROST UND POLYURETHANMATRATZE

1ARGPDP

Cat.3	2.533,00
Cat.4	2.625,00
Cat.5	2.694,00
Cat.6	2.762,00
Cat.7	2.854,00
Cat.8	2.945,00
Cat.9	3.220,00
Cat.10	3.403,00
Cat.11	3.609,00
Cat.12	3.816,00
Cat.13	4.067,00

07 S74 N/E D. ORANGE 03.2023

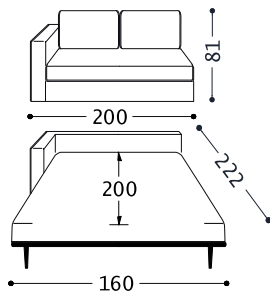

1ARGD3SXDP

DREI SITZER SOFA ARMLEHNE LINKS MIT LATTENROST UND POLYURETHANMATRATZE
DREI SITZER SOFA ARMLEHNE RECHTS MIT LATTENROST UND POLYURETHANMATRATZE

1ARGD3SXDP

1ARGD3DXDP

Cat.3	3.249,00
Cat.4	3.364,00
Cat.5	3.449,00
Cat.6	3.535,00
Cat.7	3.649,00
Cat.8	3.764,00
Cat.9	4.107,00
Cat.10	4.335,00
Cat.11	4.592,00
Cat.12	4.850,00
Cat.13	5.164,00

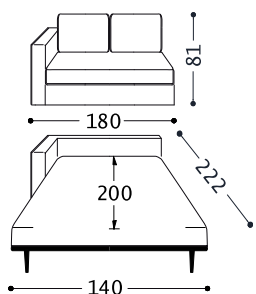

1ARGD2MSXDP

ZWEI SITZER MAXI SOFA ARMLEHNE LINKS MIT LATTENROST UND POLYURETHANMATRATZE
ZWEI SITZER MAXI SOFA ARMLEHNE RECHTS MIT LATTENROST UND POLYURETHANMATRATZE

1ARGD2MSXDP

1ARGD2MDXDP

Cat.3	2.944,00
Cat.4	3.047,00
Cat.5	3.125,00
Cat.6	3.203,00
Cat.7	3.307,00
Cat.8	3.410,00
Cat.9	3.721,00
Cat.10	3.928,00
Cat.11	4.162,00
Cat.12	4.395,00
Cat.13	4.680,00

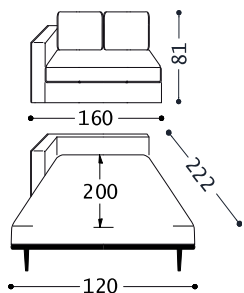

1ARGD2SXDP

ZWEI SITZER SOFA ARMLEHNE LINKS MIT LATTENROST UND POLYURETHANMATRATZE
ZWEI SITZER SOFA ARMLEHNE RECHTS MIT LATTENROST UND POLYURETHANMATRATZE

1ARGD2SXDP

1ARGD2DXDP

Cat.3	2.764,00
Cat.4	2.861,00
Cat.5	2.934,00
Cat.6	3.007,00
Cat.7	3.104,00
Cat.8	3.201,00
Cat.9	3.493,00
Cat.10	3.688,00
Cat.11	3.907,00
Cat.12	4.125,00
Cat.13	4.393,00

07 S74 N/E D. ORANGE 03.2023

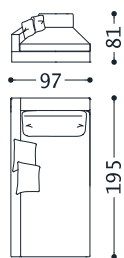

1ARGMERSX

MERIDIENNE LINKS
MERIDIENNE RECHTS

1ARGMERSX	
1ARGMERDX	
Cat.3	1.932,00
Cat.4	2.062,00
Cat.5	2.159,00
Cat.6	2.256,00
Cat.7	2.385,00
Cat.8	2.514,00
Cat.9	2.902,00
Cat.10	3.160,00
Cat.11	3.451,00
Cat.12	3.742,00
Cat.13	4.097,00

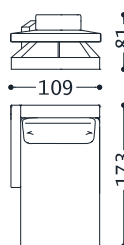

1ARGDORMCSX

LINKE DORMEUSE MIT BEHALTERKASTEN
RECHTE DORMEUSE MIT BEHALTERKASTEN

1ARGDORMCSX	
1ARGDORMCDX	
Cat.3	1.985,00
Cat.4	2.084,00
Cat.5	2.158,00
Cat.6	2.232,00
Cat.7	2.330,00
Cat.8	2.429,00
Cat.9	2.725,00
Cat.10	2.923,00
Cat.11	3.145,00
Cat.12	3.367,00
Cat.13	3.638,00

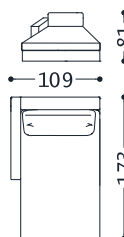

1ARGDORMSX

DORMEUSE ARMLEHNE LINKS
DORMEUSE ARMLEHNE RECHTS

1ARGDORMSX	
1ARGDORMDX	
Cat.3	1.734,00
Cat.4	1.833,00
Cat.5	1.908,00
Cat.6	1.982,00
Cat.7	2.081,00
Cat.8	2.181,00
Cat.9	2.479,00
Cat.10	2.678,00
Cat.11	2.902,00
Cat.12	3.125,00
Cat.13	3.399,00

07 S74 N/E D. ORANGE 03.2023

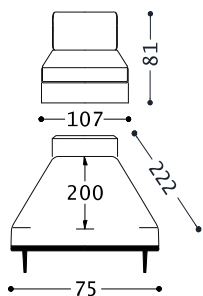

1ARGPSBDP

SESSEL OHNE ARMLEHNEN MIT
LATTENROST UND
POLYURETHANMATRATZE

1ARGPSBDP

Cat.3	2.244,00
Cat.4	2.321,00
Cat.5	2.379,00
Cat.6	2.436,00
Cat.7	2.513,00
Cat.8	2.589,00
Cat.9	2.819,00
Cat.10	2.973,00
Cat.11	3.145,00
Cat.12	3.318,00
Cat.13	3.529,00

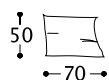

1ARGCSC

MERIDIENNE RÜCKENKISSEN

1ARGCSC

Cat.3	94,00
Cat.4	105,00
Cat.5	113,00
Cat.6	121,00
Cat.7	131,00
Cat.8	142,00
Cat.9	174,00
Cat.10	195,00
Cat.11	219,00
Cat.12	243,00
Cat.13	272,00

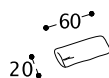

1ARGCPP

LOSE RÜCKENKISSEN AUS FEDER

1ARGCPP

Cat.3	73,00
Cat.4	83,00
Cat.5	91,00
Cat.6	99,00
Cat.7	110,00
Cat.8	121,00
Cat.9	153,00
Cat.10	174,00
Cat.11	198,00
Cat.12	222,00
Cat.13	251,00

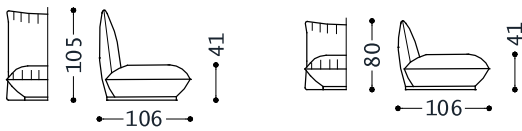

07 S74 N/E D. ORANGE 03.2023

UNS IMMER EINE ZEICHNUNG VON DEN KOMPOSITIONEN MIT DER BESTELLUNG SCHICKEN. DIE STOFF-VERSION IST ABNEHMBAR. DER SESSEL "SMALL" (KODE 1BVNPS) KANN MIT UNTERSCHIEDLICHEN STOFFEN FÜR RÜCKEN UND SITZEN BEKLEIDET WERDEN. WIR KÖNNEN KEINE GARANTIE FÜR DIE ZENTRIERUNG VON ZEICHNUNGEN UND STREIFEN ZWISCHEN DEN SITZ UND RÜCKENKISSEN GEBEN. BEI UNIFARBIGEN STOFFEN SIND DIE STEPPNÄHTE SICHTBARER. MODELL AUS KUNSTLEDER NICHT VERFÜGBAR. VORSICHT: DIE GRÖSSE ALLER RÜCKENLEHNEN DARF DIE GRÖSSE ALLER SITZFLÄCHEN NICHT ÜBERSCHREITEN. DER SESSEL "SMALL" (KODE 1BVNPS/2BVNPS) KANN KEINE ARMLEHNEN HABEN.

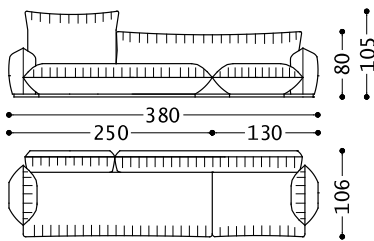

- 2 ARMLEHNE
- 1 HOHE RÜCKLEHNE A
- 1 NIEDRIGE RÜCKLEHNE D
- 1 SITZ TEILE A
- 1 SITZ TEILE D

01BVNC1		02BVNC1	
Cat.3	6.996,00	Cat.E	8.603,00
Cat.4	7.245,00	Cat.F	9.981,00
Cat.5	7.434,00	Cat.G	10.613,00
Cat.6	7.623,00	Cat.H	11.531,00
Cat.7	7.873,00	Cat.I	13.311,00
Cat.8	8.124,00	Cat.L	14.117,00
Cat.9	8.875,00	Cat.M	15.151,00
Cat.10	9.378,00		
Cat.11	9.943,00		
Cat.12	10.507,00		
Cat.13	11.196,00		

01BVNC1

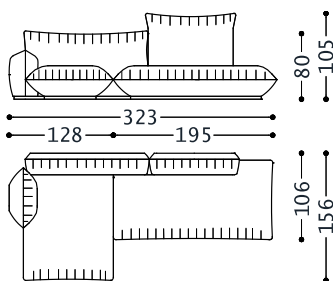

- 1 ARMLEHNE
- 1 LIEGE SITZ
- 1 HOHE RÜCKLEHNE A
- 1 NIEDRIGE RÜCKLEHNE B
- 1 SITZ TEILE C

01BVNC2

01BVNC2		02BVNC2	
Cat.3	5.970,00	Cat.E	7.482,00
Cat.4	6.186,00	Cat.F	8.797,00
Cat.5	6.350,00	Cat.G	9.400,00
Cat.6	6.513,00	Cat.H	10.276,00
Cat.7	6.730,00	Cat.I	11.975,00
Cat.8	6.948,00	Cat.L	12.742,00
Cat.9	7.599,00	Cat.M	13.729,00
Cat.10	8.034,00		
Cat.11	8.524,00		
Cat.12	9.014,00		
Cat.13	9.611,00		

07 S74 N/E D. ORANGE 03.2023

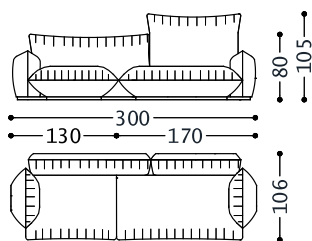

01BVNC3

- 2 ARMLEHNE
- 1 HOHE RÜCKLEHNE A
- 1 NIEDRIGE RÜCKLEHNE B
- 1 SITZ TEILE A
- 1 SITZ TEILE B

01BVNC3		02BVNC3	
Cat.3	5.947,00	Cat.E	7.317,00
Cat.4	6.161,00	Cat.F	8.481,00
Cat.5	6.323,00	Cat.G	9.015,00
Cat.6	6.485,00	Cat.H	9.791,00
Cat.7	6.699,00	Cat.I	11.294,00
Cat.8	6.915,00	Cat.L	11.975,00
Cat.9	7.560,00	Cat.M	12.849,00
Cat.10	7.990,00		
Cat.11	8.475,00		
Cat.12	8.960,00		
Cat.13	9.551,00		

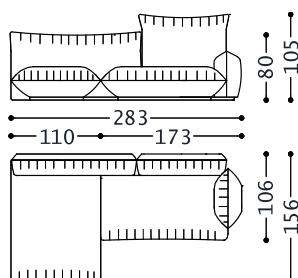

01BVNC4

- 1 ARMLEHNE
- 1 LIEGE SITZ
- 1 HOHE RÜCKLEHNE A
- 1 NIEDRIGE RÜCKLEHNE B
- 1 SITZ TEILE B

01BVNC4		02BVNC4	
Cat.3	5.674,00	Cat.E	7.161,00
Cat.4	5.884,00	Cat.F	8.435,00
Cat.5	6.043,00	Cat.G	9.019,00
Cat.6	6.203,00	Cat.H	9.868,00
Cat.7	6.413,00	Cat.I	11.512,00
Cat.8	6.625,00	Cat.L	12.256,00
Cat.9	7.260,00	Cat.M	13.212,00
Cat.10	7.682,00		
Cat.11	8.159,00		
Cat.12	8.636,00		
Cat.13	9.217,00		

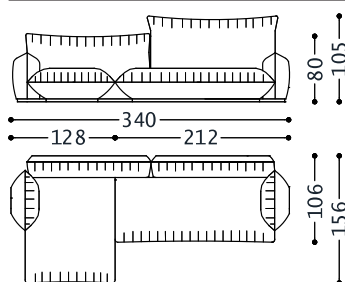

01BVNC6

- 2 ARMLEHNE
- 1 LIEGE SITZ
- 1 HOHE RÜCKLEHNE B
- 1 NIEDRIGE RÜCKLEHNE B
- 1 SITZ TEILE C

01BVNC6		02BVNC6	
Cat.3	6.973,00	Cat.E	8.677,00
Cat.4	7.221,00	Cat.F	10.150,00
Cat.5	7.409,00	Cat.G	10.825,00
Cat.6	7.597,00	Cat.H	11.804,00
Cat.7	7.845,00	Cat.I	13.707,00
Cat.8	8.095,00	Cat.L	14.565,00
Cat.9	8.842,00	Cat.M	15.671,00
Cat.10	9.341,00		
Cat.11	9.903,00		
Cat.12	10.465,00		
Cat.13	11.151,00		

07 S74 N/E D. ORANGE 03.2023

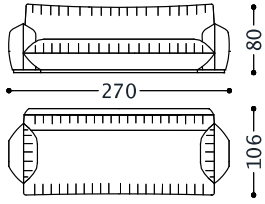

01BVNC7

2 ARMLEHNE
1 NIEDRIGE RÜCKLEHNE D
1 SITZ TEILE D

01BVNC7	
Cat.3	4.887,00
Cat.4	5.060,00
Cat.5	5.191,00
Cat.6	5.324,00
Cat.7	5.497,00
Cat.8	5.671,00
Cat.9	6.194,00
Cat.10	6.544,00
Cat.11	6.937,00
Cat.12	7.329,00
Cat.13	7.809,00

02BVNC7	
Cat.E	5.942,00
Cat.F	6.863,00
Cat.G	7.285,00
Cat.H	7.897,00
Cat.I	9.086,00
Cat.L	9.624,00
Cat.M	10.315,00

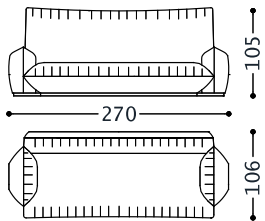

01BVNC8

2 ARMLEHNE
1 HOHE RÜCKLEHNE D
1 SITZ TEILE D

01BVNC8	
Cat.3	5.012,00
Cat.4	5.186,00
Cat.5	5.316,00
Cat.6	5.449,00
Cat.7	5.623,00
Cat.8	5.796,00
Cat.9	6.319,00
Cat.10	6.669,00
Cat.11	7.062,00
Cat.12	7.454,00
Cat.13	7.934,00

02BVNC8	
Cat.E	6.151,00
Cat.F	7.124,00
Cat.G	7.570,00
Cat.H	8.217,00
Cat.I	9.474,00
Cat.L	10.042,00
Cat.M	10.772,00

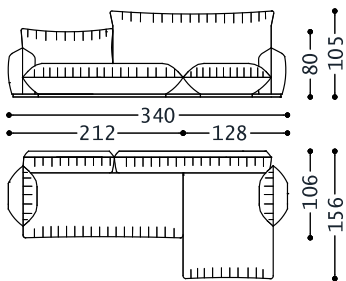

01BVNC9

2 ARMLEHNE
1 LIEGE SITZ
1 HOHE RÜCKLEHNE C
1 NIEDRIGE RÜCKLEHNE A
1 SITZ TEILE C

01BVNC9	
Cat.3	6.942,00
Cat.4	7.191,00
Cat.5	7.377,00
Cat.6	7.566,00
Cat.7	7.815,00
Cat.8	8.063,00
Cat.9	8.810,00
Cat.10	9.311,00
Cat.11	9.872,00
Cat.12	10.434,00
Cat.13	11.120,00

02BVNC9	
Cat.E	8.629,00
Cat.F	10.081,00
Cat.G	10.747,00
Cat.H	11.714,00
Cat.I	13.592,00
Cat.L	14.439,00
Cat.M	15.529,00

07 S74 N/E D. ORANGE 03.2023

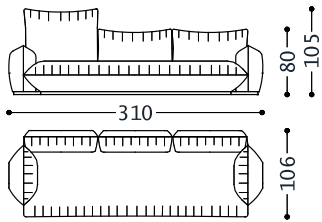

01BVNC10

- 2 ARMLEHNE
- 1 HOHE RÜCKLEHNE F
- 2 NIEDRIGE RÜCKLEHNE F
- 1 SITZ TEILE E

01BVNC10		02BVNC10	
Cat.3	5.924,00	Cat.E	7.201,00
Cat.4	6.138,00	Cat.F	8.367,00
Cat.5	6.297,00	Cat.G	8.901,00
Cat.6	6.458,00	Cat.H	9.674,00
Cat.7	6.672,00	Cat.I	11.179,00
Cat.8	6.885,00	Cat.L	11.860,00
Cat.9	7.527,00	Cat.M	12.733,00
Cat.10	7.955,00		
Cat.11	8.435,00		
Cat.12	8.917,00		
Cat.13	9.505,00		

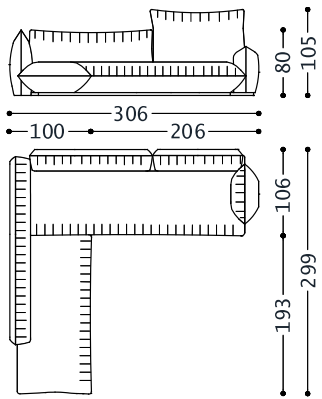

01BVNC12

- 1 ARMLEHNE
- 1 HOHE RÜCKLEHNE A
- 1 NIEDRIGE RÜCKLEHNE B
- 1 NIEDRIGE RÜCKLEHNE D
- 1 SITZ TEILE C
- 1 SITZ TEILE E

01BVNC12		02BVNC12	
Cat.3	8.364,00	Cat.E	10.228,00
Cat.4	8.672,00	Cat.F	11.892,00
Cat.5	8.905,00	Cat.G	12.655,00
Cat.6	9.136,00	Cat.H	13.763,00
Cat.7	9.445,00	Cat.I	15.913,00
Cat.8	9.755,00	Cat.L	16.884,00
Cat.9	10.681,00	Cat.M	18.132,00
Cat.10	11.299,00		
Cat.11	11.994,00		
Cat.12	12.690,00		
Cat.13	13.539,00		

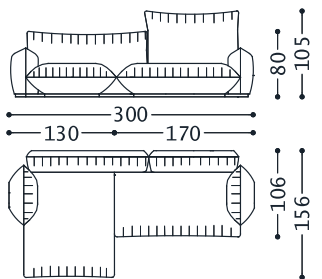

01BVNC14

- 2 ARMLEHNE
- 1 LIEGE SITZ
- 1 HOHE RÜCKLEHNE A
- 1 NIEDRIGE RÜCKLEHNE B
- 1 SITZ TEILE B

01BVNC14		02BVNC14	
Cat.3	6.306,00	Cat.E	7.930,00
Cat.4	6.536,00	Cat.F	9.313,00
Cat.5	6.710,00	Cat.G	9.947,00
Cat.6	6.886,00	Cat.H	10.868,00
Cat.7	7.116,00	Cat.I	12.653,00
Cat.8	7.348,00	Cat.L	13.461,00
Cat.9	8.044,00	Cat.M	14.499,00
Cat.10	8.507,00		
Cat.11	9.030,00		
Cat.12	9.553,00		
Cat.13	10.190,00		

07 S74 N/E D. ORANGE 03.2023

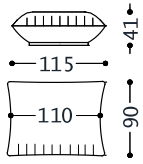

1BVNSEDA

SITZ TEILE A

1BVNSEDA		2BVNSEDA	
Cat.3	1.141,00	Cat.E	1.412,00
Cat.4	1.177,00	Cat.F	1.625,00
Cat.5	1.204,00	Cat.G	1.723,00
Cat.6	1.230,00	Cat.H	1.866,00
Cat.7	1.266,00	Cat.I	2.142,00
Cat.8	1.302,00	Cat.L	2.267,00
Cat.9	1.408,00	Cat.M	2.427,00
Cat.10	1.480,00		
Cat.11	1.560,00		
Cat.12	1.640,00		
Cat.13	1.738,00		

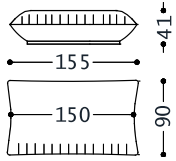

1BVNSEDB

SITZ TEILE B

1BVNSEDB		2BVNSEDB	
Cat.3	1.444,00	Cat.E	1.747,00
Cat.4	1.490,00	Cat.F	2.000,00
Cat.5	1.524,00	Cat.G	2.116,00
Cat.6	1.559,00	Cat.H	2.285,00
Cat.7	1.604,00	Cat.I	2.611,00
Cat.8	1.650,00	Cat.L	2.759,00
Cat.9	1.788,00	Cat.M	2.949,00
Cat.10	1.879,00		
Cat.11	1.982,00		
Cat.12	2.085,00		
Cat.13	2.211,00		

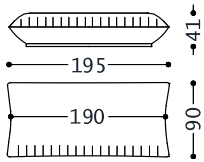

1BVNSEDC

SITZ TEILE C

1BVNSEDC		2BVNSEDC	
Cat.3	1.740,00	Cat.E	2.068,00
Cat.4	1.792,00	Cat.F	2.362,00
Cat.5	1.831,00	Cat.G	2.497,00
Cat.6	1.869,00	Cat.H	2.693,00
Cat.7	1.921,00	Cat.I	3.074,00
Cat.8	1.973,00	Cat.L	3.245,00
Cat.9	2.127,00	Cat.M	3.466,00
Cat.10	2.231,00		
Cat.11	2.347,00		
Cat.12	2.463,00		
Cat.13	2.605,00		

07 S74 N/E D. ORANGE 03.2023

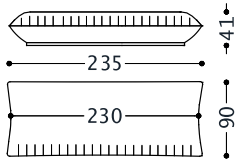

1BVNSEDD

SITZ TEILE D

1BVNSEDD		2BVNSEDD	
Cat.3	1.991,00	Cat.E	2.412,00
Cat.4	2.049,00	Cat.F	2.779,00
Cat.5	2.093,00	Cat.G	2.947,00
Cat.6	2.137,00	Cat.H	3.191,00
Cat.7	2.195,00	Cat.I	3.664,00
Cat.8	2.253,00	Cat.L	3.878,00
Cat.9	2.427,00	Cat.M	4.153,00
Cat.10	2.544,00		
Cat.11	2.675,00		
Cat.12	2.805,00		
Cat.13	2.965,00		

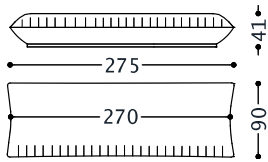

1BVNSEDE

SITZ TEILE E

1BVNSEDE		2BVNSEDE	
Cat.3	2.262,00	Cat.E	2.779,00
Cat.4	2.331,00	Cat.F	3.224,00
Cat.5	2.382,00	Cat.G	3.428,00
Cat.6	2.433,00	Cat.H	3.724,00
Cat.7	2.502,00	Cat.I	4.299,00
Cat.8	2.570,00	Cat.L	4.559,00
Cat.9	2.775,00	Cat.M	4.892,00
Cat.10	2.912,00		
Cat.11	3.065,00		
Cat.12	3.219,00		
Cat.13	3.407,00		

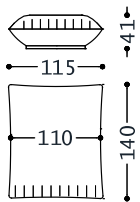

1BVNCHL

LIEGE SITZ

1BVNCHL		2BVNCHL	
Cat.3	1.500,00	Cat.E	2.025,00
Cat.4	1.552,00	Cat.F	2.457,00
Cat.5	1.591,00	Cat.G	2.655,00
Cat.6	1.631,00	Cat.H	2.943,00
Cat.7	1.683,00	Cat.I	3.501,00
Cat.8	1.735,00	Cat.L	3.753,00
Cat.9	1.892,00	Cat.M	4.077,00
Cat.10	1.997,00		
Cat.11	2.115,00		
Cat.12	2.233,00		
Cat.13	2.377,00		

07 S74 N/E D. ORANGE 03.2023

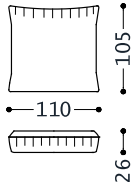

1BVNSCAA

HOHE RÜCKLEHNE A

1BVNSCAA		2BVNSCAA	
Cat.3	968,00	Cat.E	1.249,00
Cat.4	1.008,00	Cat.F	1.493,00
Cat.5	1.039,00	Cat.G	1.605,00
Cat.6	1.069,00	Cat.H	1.768,00
Cat.7	1.110,00	Cat.I	2.083,00
Cat.8	1.151,00	Cat.L	2.226,00
Cat.9	1.273,00	Cat.M	2.409,00
Cat.10	1.354,00		
Cat.11	1.446,00		
Cat.12	1.538,00		
Cat.13	1.649,00		

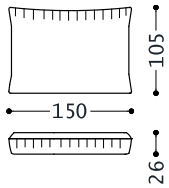

1BVNSCAB

HOHE RÜCKLEHNE B

1BVNSCAB		2BVNSCAB	
Cat.3	1.339,00	Cat.E	1.675,00
Cat.4	1.391,00	Cat.F	1.968,00
Cat.5	1.431,00	Cat.G	2.102,00
Cat.6	1.470,00	Cat.H	2.296,00
Cat.7	1.522,00	Cat.I	2.674,00
Cat.8	1.575,00	Cat.L	2.844,00
Cat.9	1.732,00	Cat.M	3.064,00
Cat.10	1.836,00		
Cat.11	1.954,00		
Cat.12	2.072,00		
Cat.13	2.216,00		

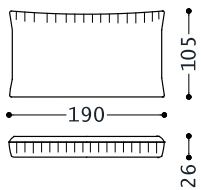

1BVNSCAC

HOHE RÜCKLEHNE C

1BVNSCAC		2BVNSCAC	
Cat.3	1.549,00	Cat.E	1.924,00
Cat.4	1.613,00	Cat.F	2.247,00
Cat.5	1.661,00	Cat.G	2.395,00
Cat.6	1.709,00	Cat.H	2.610,00
Cat.7	1.773,00	Cat.I	3.027,00
Cat.8	1.837,00	Cat.L	3.215,00
Cat.9	2.029,00	Cat.M	3.457,00
Cat.10	2.157,00		
Cat.11	2.301,00		
Cat.12	2.445,00		
Cat.13	2.621,00		

07 S74 N/E D. ORANGE 03.2023

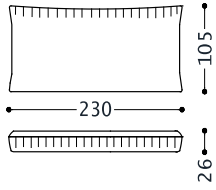

1BVNSCAD

HOHE RÜCKLEHNE D

1BVNSCAD		2BVNSCAD	
Cat.3	1.757,00	Cat.E	2.201,00
Cat.4	1.833,00	Cat.F	2.589,00
Cat.5	1.889,00	Cat.G	2.767,00
Cat.6	1.946,00	Cat.H	3.026,00
Cat.7	2.022,00	Cat.I	3.528,00
Cat.8	2.097,00	Cat.L	3.754,00
Cat.9	2.324,00	Cat.M	4.045,00
Cat.10	2.475,00		
Cat.11	2.645,00		
Cat.12	2.815,00		
Cat.13	3.023,00		

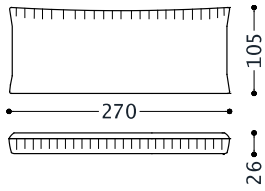

1BVNSCAE

HOHE RÜCKLEHNE E

1BVNSCAE		2BVNSCAE	
Cat.3	2.029,00	Cat.E	2.573,00
Cat.4	2.116,00	Cat.F	3.044,00
Cat.5	2.181,00	Cat.G	3.260,00
Cat.6	2.247,00	Cat.H	3.574,00
Cat.7	2.334,00	Cat.I	4.183,00
Cat.8	2.421,00	Cat.L	4.457,00
Cat.9	2.683,00	Cat.M	4.811,00
Cat.10	2.858,00		
Cat.11	3.054,00		
Cat.12	3.250,00		
Cat.13	3.490,00		

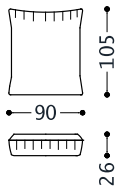

1BVNSCAF

HOHE RÜCKLEHNE F

1BVNSCAF		2BVNSCAF	
Cat.3	878,00	Cat.E	1.096,00
Cat.4	913,00	Cat.F	1.297,00
Cat.5	939,00	Cat.G	1.389,00
Cat.6	965,00	Cat.H	1.522,00
Cat.7	1.000,00	Cat.I	1.782,00
Cat.8	1.035,00	Cat.L	1.899,00
Cat.9	1.140,00	Cat.M	2.049,00
Cat.10	1.209,00		
Cat.11	1.288,00		
Cat.12	1.366,00		
Cat.13	1.462,00		

07 S74 N/E D. ORANGE 03.2023

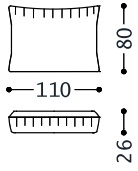

1BVNSCBA

NIEDRIGE RÜCKLEHNE A

1BVNSCBA		2BVNSCBA	
Cat.3	889,00	Cat.E	1.074,00
Cat.4	930,00	Cat.F	1.259,00
Cat.5	960,00	Cat.G	1.344,00
Cat.6	991,00	Cat.H	1.468,00
Cat.7	1.032,00	Cat.I	1.708,00
Cat.8	1.072,00	Cat.L	1.816,00
Cat.9	1.194,00	Cat.M	1.955,00
Cat.10	1.276,00		
Cat.11	1.367,00		
Cat.12	1.459,00		
Cat.13	1.571,00		

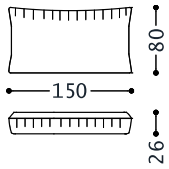

1BVNSCBB

NIEDRIGE RÜCKLEHNE B

1BVNSCBB		2BVNSCBB	
Cat.3	1.130,00	Cat.E	1.371,00
Cat.4	1.182,00	Cat.F	1.607,00
Cat.5	1.222,00	Cat.G	1.715,00
Cat.6	1.261,00	Cat.H	1.872,00
Cat.7	1.313,00	Cat.I	2.176,00
Cat.8	1.366,00	Cat.L	2.313,00
Cat.9	1.523,00	Cat.M	2.490,00
Cat.10	1.627,00		
Cat.11	1.745,00		
Cat.12	1.863,00		
Cat.13	2.007,00		

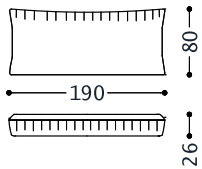

1BVNSCBC

NIEDRIGE RÜCKLEHNE C

1BVNSCBC		2BVNSCBC	
Cat.3	1.415,00	Cat.E	1.712,00
Cat.4	1.479,00	Cat.F	1.987,00
Cat.5	1.527,00	Cat.G	2.113,00
Cat.6	1.575,00	Cat.H	2.296,00
Cat.7	1.639,00	Cat.I	2.651,00
Cat.8	1.703,00	Cat.L	2.811,00
Cat.9	1.895,00	Cat.M	3.017,00
Cat.10	2.023,00		
Cat.11	2.167,00		
Cat.12	2.311,00		
Cat.13	2.487,00		

07 S74 N/E D. ORANGE 03.2023

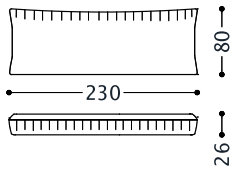

1BVNSCBD

NIEDRIGE RÜCKLEHNE D

1BVNSCBD		2BVNSCBD	
Cat.3	1.632,00	Cat.E	1.992,00
Cat.4	1.707,00	Cat.F	2.328,00
Cat.5	1.764,00	Cat.G	2.482,00
Cat.6	1.821,00	Cat.H	2.706,00
Cat.7	1.896,00	Cat.I	3.140,00
Cat.8	1.972,00	Cat.L	3.336,00
Cat.9	2.199,00	Cat.M	3.588,00
Cat.10	2.350,00		
Cat.11	2.520,00		
Cat.12	2.690,00		
Cat.13	2.898,00		

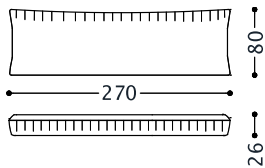

1BVNSCBE

NIEDRIGE RÜCKLEHNE E

1BVNSCBE		2BVNSCBE	
Cat.3	1.910,00	Cat.E	2.350,00
Cat.4	1.997,00	Cat.F	2.751,00
Cat.5	2.063,00	Cat.G	2.935,00
Cat.6	2.128,00	Cat.H	3.203,00
Cat.7	2.215,00	Cat.I	3.721,00
Cat.8	2.303,00	Cat.L	3.955,00
Cat.9	2.564,00	Cat.M	4.256,00
Cat.10	2.739,00		
Cat.11	2.935,00		
Cat.12	3.131,00		
Cat.13	3.371,00		

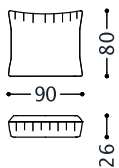

1BVNSCBF

NIEDRIGE RÜCKLEHNE F

1BVNSCBF		2BVNSCBF	
Cat.3	760,00	Cat.E	894,00
Cat.4	795,00	Cat.F	1.045,00
Cat.5	821,00	Cat.G	1.114,00
Cat.6	847,00	Cat.H	1.214,00
Cat.7	882,00	Cat.I	1.408,00
Cat.8	917,00	Cat.L	1.496,00
Cat.9	1.022,00	Cat.M	1.609,00
Cat.10	1.092,00		
Cat.11	1.170,00		
Cat.12	1.249,00		
Cat.13	1.345,00		

07 S74 N/E D. ORANGE 03.2023

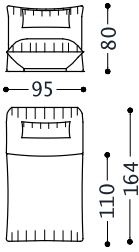

1BVNDORM

DORMEUSE OHNE ARMLEHNEN
(KOPFLEHNE INKLUSIVE)

1BVNDORM		2BVNDORM	
Cat.3	1.867,00	Cat.E	2.485,00
Cat.4	1.951,00	Cat.F	3.052,00
Cat.5	2.014,00	Cat.G	3.312,00
Cat.6	2.076,00	Cat.H	3.690,00
Cat.7	2.160,00	Cat.I	4.422,00
Cat.8	2.244,00	Cat.L	4.753,00
Cat.9	2.494,00	Cat.M	5.178,00
Cat.10	2.662,00		
Cat.11	2.850,00		
Cat.12	3.038,00		
Cat.13	3.268,00		

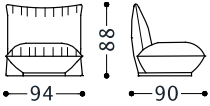

1BVNPS

SESSEL SMALL

DIESER SESSEL KANN KEINE ARMLEHNEN HABEN

1BVNPS		2BVNPS	
Cat.3	1.529,00	Cat.E	2.007,00
Cat.4	1.588,00	Cat.F	2.395,00
Cat.5	1.633,00	Cat.G	2.573,00
Cat.6	1.678,00	Cat.H	2.832,00
Cat.7	1.737,00	Cat.I	3.334,00
Cat.8	1.797,00	Cat.L	3.560,00
Cat.9	1.976,00	Cat.M	3.851,00
Cat.10	2.095,00		
Cat.11	2.229,00		
Cat.12	2.363,00		
Cat.13	2.527,00		

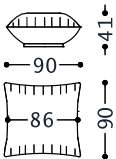

1BVNPFQ

QUADRATISCHER HOCKER

1BVNPFQ		2BVNPFQ	
Cat.3	896,00	Cat.E	1.114,00
Cat.4	928,00	Cat.F	1.301,00
Cat.5	952,00	Cat.G	1.387,00
Cat.6	976,00	Cat.H	1.512,00
Cat.7	1.008,00	Cat.I	1.754,00
Cat.8	1.040,00	Cat.L	1.864,00
Cat.9	1.136,00	Cat.M	2.005,00
Cat.10	1.200,00		
Cat.11	1.272,00		
Cat.12	1.344,00		
Cat.13	1.432,00		

07 S74 N/E D. ORANGE 03.2023

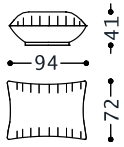

1BVNPFFSM

SMALL HOCKER

1BVNPFFSM		2BVNPFFSM	
Cat.3	762,00	Cat.E	938,00
Cat.4	792,00	Cat.F	1.078,00
Cat.5	814,00	Cat.G	1.142,00
Cat.6	836,00	Cat.H	1.235,00
Cat.7	866,00	Cat.I	1.415,00
Cat.8	896,00	Cat.L	1.497,00
Cat.9	985,00	Cat.M	1.601,00
Cat.10	1.045,00		
Cat.11	1.112,00		
Cat.12	1.179,00		
Cat.13	1.261,00		

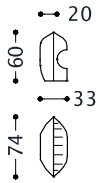

1BVNBR

ARMLEHNE

1BVNBR		2BVNBR	
Cat.3	632,00	Cat.E	769,00
Cat.4	652,00	Cat.F	878,00
Cat.5	667,00	Cat.G	928,00
Cat.6	683,00	Cat.H	1.000,00
Cat.7	703,00	Cat.I	1.141,00
Cat.8	723,00	Cat.L	1.205,00
Cat.9	784,00	Cat.M	1.287,00
Cat.10	825,00		
Cat.11	871,00		
Cat.12	917,00		
Cat.13	973,00		

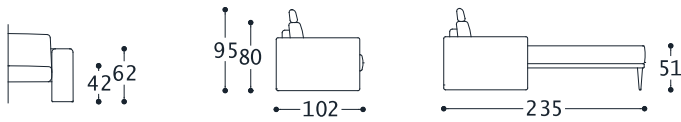

07 S74 N/E D. ORANGE 03.2023

DIE STOFF-VERSION IST ABNEHMBAR UND MAN KANN SITZKISSEN, CHASSIS UND RÜCKENKISSEN MIT UNTERSCHIEDLICHEN STOFFEN BEZIEHEN. GESTREIFTE STOFFE ODER STOFFE MIT MUSTERN EIGNEN SICH NUR FÜR RÜCKENKISSEN. LIEFERBAR AUCH AUS KUNSTLEDER (NICHT ABNEHMBAR). STANDARD RÜCKENKISSEN AUS DAUNENGEMISCH. AUF WUNSCH KANN MAN AUCH MIT RÜCKENKISSEN AUS POLYURETANSCHAUM GELIEFERT. ES IST ERFORDERLICH, AM ENDE DES ARTIKELCODES EINE "G" EINZUFÜGEN ZB.: 1MN2D3G/2MN2D3G. DIE ELEMENTE WERDEN MIT ABS FUSS H. 4 CM (Kod. 650) STANDARD GELIEFERT. AUF WUNSCH KANN MAN AUCH MIT FÜSSE AUS METALL VERCHROMT, H. 4 CM - (Kod. 159), DIE EINEN AUFSCHLAG VON 210,00 EURO PRO STÜCK AUF DER PREISLISTE HAT. WENN NICHT ANGEZEIGT, WERDEN STANDARD FÜSSE KODE 650 GELIEFERT. DIE SCHLAFSOFAS SIND MIT POLYURETHANSCHAUMMATRATZE H. 11 CM UND MIT SPEZIELLEM LATTENROST GELIEFERT:DARAN WERDEN DIE SITZKISSEN BEFESTIGT.

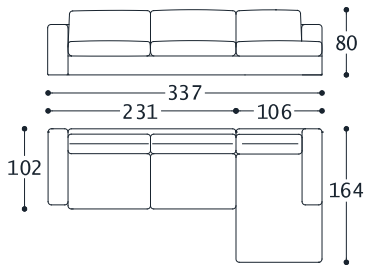

01BD2C4

1 DORMEUSE ARMLEHNE RECHTS
1 DREI SITZER MAXI SOFA ARMLEHNE LINKS

01BD2C4		02BD2C4	
Cat.3	3.633,00	Cat.E	5.119,00
Cat.4	3.894,00	Cat.F	6.375,00
Cat.5	4.090,00	Cat.G	6.952,00
Cat.6	4.287,00	Cat.H	7.790,00
Cat.7	4.547,00	Cat.I	9.413,00
Cat.8	4.808,00	Cat.L	10.147,00
Cat.9	5.592,00	Cat.M	11.090,00
Cat.10	6.115,00		
Cat.11	6.702,00		
Cat.12	7.291,00		
Cat.13	8.009,00		

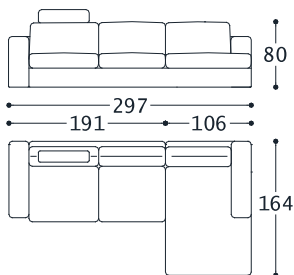

01BD2C1

1 DORMEUSE ARMLEHNE RECHTS
1 ZWEI SITZER MAXI SOFA ARMLEHNE LINKS
1 KOPFLEHNE 74 CM (FÜR ZWEI SITZER MAXI SOFA UND DORMEUSE)

01BD2C1		02BD2C1	
Cat.3	3.370,00	Cat.E	4.760,00
Cat.4	3.636,00	Cat.F	5.946,00
Cat.5	3.837,00	Cat.G	6.490,00
Cat.6	4.037,00	Cat.H	7.282,00
Cat.7	4.304,00	Cat.I	8.814,00
Cat.8	4.571,00	Cat.L	9.508,00
Cat.9	5.371,00	Cat.M	10.398,00
Cat.10	5.906,00		
Cat.11	6.507,00		
Cat.12	7.108,00		
Cat.13	7.842,00		

BROADWAY 2

Währung: EUR

alberta
Made in Italy

07 S74 N/E D. ORANGE 03.2023

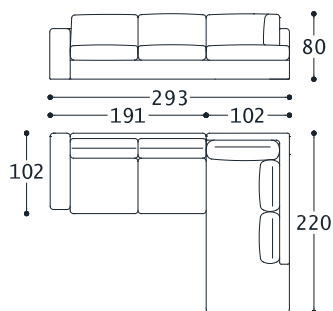

01BD2C7

1 ZWEI SITZER MAXI SOFA ARMLEHNE
LINKS
1 MERIDIENNE RECHTS

01BD2C7		02BD2C7	
Cat.3	3.763,00	Cat.E	5.299,00
Cat.4	4.091,00	Cat.F	6.619,00
Cat.5	4.338,00	Cat.G	7.224,00
Cat.6	4.584,00	Cat.H	8.104,00
Cat.7	4.913,00	Cat.I	9.810,00
Cat.8	5.241,00	Cat.L	10.581,00
Cat.9	6.226,00	Cat.M	11.571,00
Cat.10	6.883,00		
Cat.11	7.622,00		
Cat.12	8.361,00		
Cat.13	9.264,00		

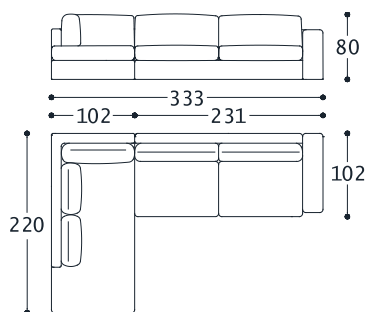

01BD2C9

1 DREI SITZER MAXI SOFA ARMLEHNE
RECHTS
1 MERIDIENNE LINKS

01BD2C9		02BD2C9	
Cat.3	4.163,00	Cat.E	5.844,00
Cat.4	4.497,00	Cat.F	7.278,00
Cat.5	4.748,00	Cat.G	7.936,00
Cat.6	5.000,00	Cat.H	8.891,00
Cat.7	5.334,00	Cat.I	10.744,00
Cat.8	5.668,00	Cat.L	11.581,00
Cat.9	6.672,00	Cat.M	12.657,00
Cat.10	7.341,00		
Cat.11	8.093,00		
Cat.12	8.846,00		
Cat.13	9.766,00		

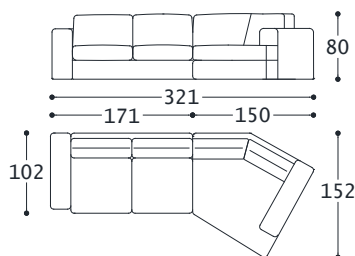

01BD2C8

1 ZWEI SITZER SOFA ARMLEHNE LINKS
1 ENDELEMENT RECHTS

01BD2C8		02BD2C8	
Cat.3	3.359,00	Cat.E	4.610,00
Cat.4	3.630,00	Cat.F	5.783,00
Cat.5	3.833,00	Cat.G	6.321,00
Cat.6	4.037,00	Cat.H	7.103,00
Cat.7	4.308,00	Cat.I	8.619,00
Cat.8	4.580,00	Cat.L	9.304,00
Cat.9	5.394,00	Cat.M	10.184,00
Cat.10	5.936,00		
Cat.11	6.548,00		
Cat.12	7.158,00		
Cat.13	7.905,00		

07 S74 N/E D. ORANGE 03.2023

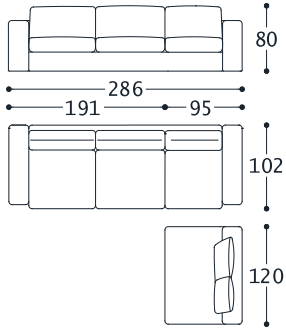

01BD2C2

1 ZWEI SITZER MAXI SOFA ARMLEHNE LINKS
1 ZENTRAL JOLLY ELEMENT (2 "JOLLY" RÜCKENKISSEN INKLUSIVE)
1 SESSEL ARMLEHNE RECHTS

01BD2C2	
Cat.3	3.978,00
Cat.4	4.295,00
Cat.5	4.533,00
Cat.6	4.769,00
Cat.7	5.086,00
Cat.8	5.403,00
Cat.9	6.352,00
Cat.10	6.985,00
Cat.11	7.698,00
Cat.12	8.410,00
Cat.13	9.280,00

02BD2C2	
Cat.E	5.733,00
Cat.F	7.190,00
Cat.G	7.858,00
Cat.H	8.830,00
Cat.I	10.713,00
Cat.L	11.563,00
Cat.M	12.657,00

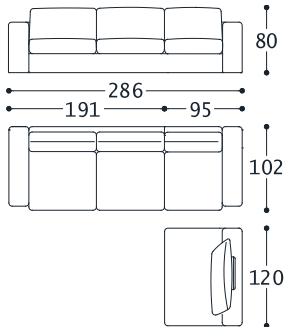

01BD2C6

1 ZWEI SITZER MAXI SOFA ARMLEHNE LINKS
1 ZENTRAL JOLLY ELEMENT 2 (1 "SPECIAL" RÜCKENKISSEN "INKLUSIVE")
1 SESSEL ARMLEHNE RECHTS

01BD2C6	
Cat.3	4.148,00
Cat.4	4.468,00
Cat.5	4.707,00
Cat.6	4.946,00
Cat.7	5.265,00
Cat.8	5.583,00
Cat.9	6.539,00
Cat.10	7.177,00
Cat.11	7.894,00
Cat.12	8.612,00
Cat.13	9.488,00

02BD2C6	
Cat.E	5.876,00
Cat.F	7.322,00
Cat.G	7.984,00
Cat.H	8.948,00
Cat.I	10.817,00
Cat.L	11.661,00
Cat.M	12.745,00

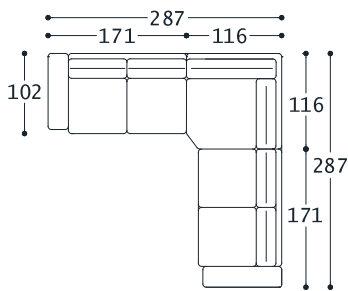

01BD2C5

1 ECKELEMENT
1 ZWEI SITZER SOFA ARMLEHNE RECHTS
1 ZWEI SITZER SOFA ARMLEHNE LINKS

01BD2C5	
Cat.3	4.572,00
Cat.4	4.971,00
Cat.5	5.270,00
Cat.6	5.570,00
Cat.7	5.968,00
Cat.8	6.368,00
Cat.9	7.564,00
Cat.10	8.360,00
Cat.11	9.259,00
Cat.12	10.156,00
Cat.13	11.254,00

02BD2C5	
Cat.E	6.556,00
Cat.F	8.159,00
Cat.G	8.893,00
Cat.H	9.962,00
Cat.I	12.032,00
Cat.L	12.969,00
Cat.M	14.170,00

07 S74 N/E D. ORANGE 03.2023

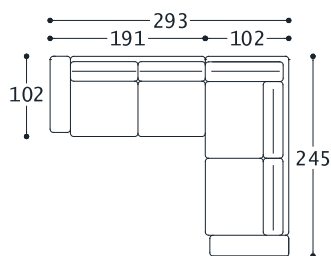

01BD2C3

1 DREI SITZER ECKELEMENT ARMLEHNE RECHTS
1 ZWEI SITZER MAXI SOFA ARMLEHNE LINKS

01BD2C3		02BD2C3	
Cat.3	3.954,00	Cat.E	5.687,00
Cat.4	4.284,00	Cat.F	7.158,00
Cat.5	4.532,00	Cat.G	7.833,00
Cat.6	4.780,00	Cat.H	8.814,00
Cat.7	5.111,00	Cat.I	10.715,00
Cat.8	5.441,00	Cat.L	11.574,00
Cat.9	6.433,00	Cat.M	12.677,00
Cat.10	7.094,00		
Cat.11	7.838,00		
Cat.12	8.583,00		
Cat.13	9.492,00		

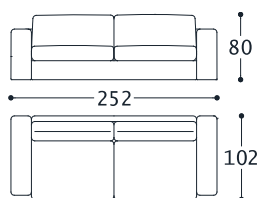

1BD2D3M

DREI SITZER MAXI SOFA

1BD2D3M		2BD2D3M	
Cat.3	2.277,00	Cat.E	3.175,00
Cat.4	2.446,00	Cat.F	3.968,00
Cat.5	2.573,00	Cat.G	4.331,00
Cat.6	2.700,00	Cat.H	4.860,00
Cat.7	2.870,00	Cat.I	5.884,00
Cat.8	3.039,00	Cat.L	6.346,00
Cat.9	3.548,00	Cat.M	6.941,00
Cat.10	3.887,00		
Cat.11	4.268,00		
Cat.12	4.649,00		
Cat.13	5.115,00		

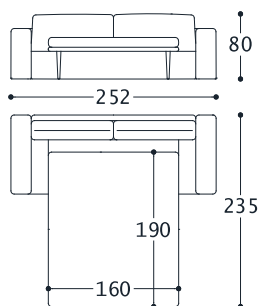

1BD2D3MSPP

DREI SITZER MAXI SOFA MIT "SPECIAL" ELEKTROGESCHWEISSTEM METALLROST UND POLYURETHANMATRATZE

1BD2D3MSPP		2BD2D3MSPP	
Cat.3	3.284,00	Cat.E	4.071,00
Cat.4	3.456,00	Cat.F	4.863,00
Cat.5	3.586,00	Cat.G	5.227,00
Cat.6	3.716,00	Cat.H	5.755,00
Cat.7	3.888,00	Cat.I	6.779,00
Cat.8	4.061,00	Cat.L	7.242,00
Cat.9	4.579,00	Cat.M	7.836,00
Cat.10	4.925,00		
Cat.11	5.313,00		
Cat.12	5.702,00		
Cat.13	6.177,00		

07 S74 N/E D. ORANGE 03.2023

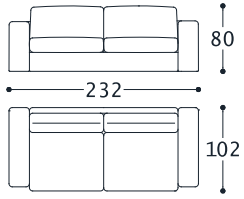

1BD2D3

DREI SITZER SOFA

1BD2D3		2BD2D3	
Cat.3	2.055,00	Cat.E	2.905,00
Cat.4	2.213,00	Cat.F	3.641,00
Cat.5	2.331,00	Cat.G	3.978,00
Cat.6	2.449,00	Cat.H	4.469,00
Cat.7	2.607,00	Cat.I	5.419,00
Cat.8	2.765,00	Cat.L	5.849,00
Cat.9	3.238,00	Cat.M	6.400,00
Cat.10	3.553,00		
Cat.11	3.907,00		
Cat.12	4.262,00		
Cat.13	4.696,00		

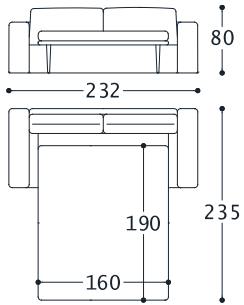

1BD2D3SPP

DREI SITER SOFA MIT "SPECIAL"
ELEKTROGESCHWEISSTEM METALLROST
UND POLYURETHANMATRATZE

1BD2D3SPP		2BD2D3SPP	
Cat.3	3.050,00	Cat.E	3.816,00
Cat.4	3.215,00	Cat.F	4.552,00
Cat.5	3.339,00	Cat.G	4.889,00
Cat.6	3.463,00	Cat.H	5.379,00
Cat.7	3.628,00	Cat.I	6.330,00
Cat.8	3.793,00	Cat.L	6.759,00
Cat.9	4.288,00	Cat.M	7.311,00
Cat.10	4.618,00		
Cat.11	4.989,00		
Cat.12	5.361,00		
Cat.13	5.814,00		

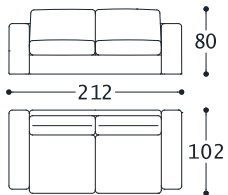

1BD2D2M

ZWEI SITZER MAXI SOFA

1BD2D2M		2BD2D2M	
Cat.3	1.868,00	Cat.E	2.631,00
Cat.4	2.026,00	Cat.F	3.314,00
Cat.5	2.144,00	Cat.G	3.627,00
Cat.6	2.262,00	Cat.H	4.082,00
Cat.7	2.420,00	Cat.I	4.965,00
Cat.8	2.577,00	Cat.L	5.364,00
Cat.9	3.050,00	Cat.M	5.876,00
Cat.10	3.366,00		
Cat.11	3.720,00		
Cat.12	4.075,00		
Cat.13	4.508,00		

07 S74 N/E D. ORANGE 03.2023

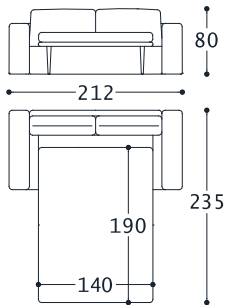

1BD2D2MSPP

ZWEI SITZER MAXI SOFA MIT "SPECIAL" ELEKTROGESCHWEISSTEM METALLROST UND POLYURETHANMATRATZE

1BD2D2MSPP		2BD2D2MSPP	
Cat.3	2.932,00	Cat.E	3.508,00
Cat.4	3.092,00	Cat.F	4.192,00
Cat.5	3.211,00	Cat.G	4.505,00
Cat.6	3.331,00	Cat.H	4.960,00
Cat.7	3.491,00	Cat.I	5.843,00
Cat.8	3.651,00	Cat.L	6.241,00
Cat.9	4.130,00	Cat.M	6.754,00
Cat.10	4.450,00		
Cat.11	4.810,00		
Cat.12	5.169,00		
Cat.13	5.609,00		

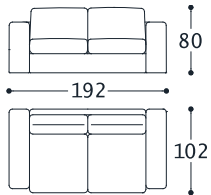

1BD2D2

ZWEI SITZER SOFA

1BD2D2		2BD2D2	
Cat.3	1.794,00	Cat.E	2.460,00
Cat.4	1.948,00	Cat.F	3.084,00
Cat.5	2.064,00	Cat.G	3.370,00
Cat.6	2.179,00	Cat.H	3.786,00
Cat.7	2.333,00	Cat.I	4.591,00
Cat.8	2.487,00	Cat.L	4.955,00
Cat.9	2.949,00	Cat.M	5.423,00
Cat.10	3.257,00		
Cat.11	3.603,00		
Cat.12	3.949,00		
Cat.13	4.373,00		

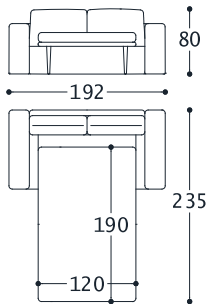

1BD2D2SPP

ZWEI SITZER SOFA MIT "SPECIAL" ELEKTROGESCHWEISSTEM METALLROST UND POLYURETHANMATRATZE

1BD2D2SPP		2BD2D2SPP	
Cat.3	2.698,00	Cat.E	3.330,00
Cat.4	2.847,00	Cat.F	3.954,00
Cat.5	2.958,00	Cat.G	4.239,00
Cat.6	3.070,00	Cat.H	4.655,00
Cat.7	3.219,00	Cat.I	5.461,00
Cat.8	3.367,00	Cat.L	5.825,00
Cat.9	3.814,00	Cat.M	6.293,00
Cat.10	4.111,00		
Cat.11	4.446,00		
Cat.12	4.780,00		
Cat.13	5.189,00		

07 S74 N/E D. ORANGE 03.2023

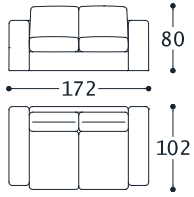

1BD2D2S

ZWEI SITZER SMALL SOFA

1BD2D2S		2BD2D2S	
Cat.3	1.697,00	Cat.E	2.317,00
Cat.4	1.847,00	Cat.F	2.891,00
Cat.5	1.959,00	Cat.G	3.154,00
Cat.6	2.071,00	Cat.H	3.536,00
Cat.7	2.220,00	Cat.I	4.278,00
Cat.8	2.370,00	Cat.L	4.612,00
Cat.9	2.818,00	Cat.M	5.043,00
Cat.10	3.117,00		
Cat.11	3.454,00		
Cat.12	3.790,00		
Cat.13	4.201,00		

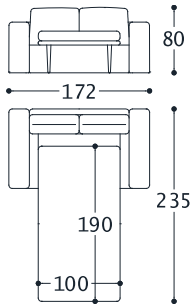

1BD2D2SSPP

ZWEI SITZER SMALL SOFA MIT "SPECIAL" ELEKTROGESCHWEISSTEM METALLROST UND POLYURETHANMATRATZE

1BD2D2SSPP		2BD2D2SSPP	
Cat.3	2.533,00	Cat.E	3.109,00
Cat.4	2.675,00	Cat.F	3.683,00
Cat.5	2.783,00	Cat.G	3.946,00
Cat.6	2.890,00	Cat.H	4.329,00
Cat.7	3.033,00	Cat.I	5.070,00
Cat.8	3.175,00	Cat.L	5.404,00
Cat.9	3.604,00	Cat.M	5.835,00
Cat.10	3.889,00		
Cat.11	4.211,00		
Cat.12	4.532,00		
Cat.13	4.925,00		

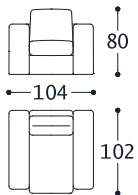

1BD2P

SESSEL

1BD2P		2BD2P	
Cat.3	1.121,00	Cat.E	1.530,00
Cat.4	1.221,00	Cat.F	1.898,00
Cat.5	1.295,00	Cat.G	2.066,00
Cat.6	1.369,00	Cat.H	2.312,00
Cat.7	1.469,00	Cat.I	2.787,00
Cat.8	1.568,00	Cat.L	3.002,00
Cat.9	1.865,00	Cat.M	3.277,00
Cat.10	2.063,00		
Cat.11	2.287,00		
Cat.12	2.510,00		
Cat.13	2.782,00		

07 S74 N/E D. ORANGE 03.2023

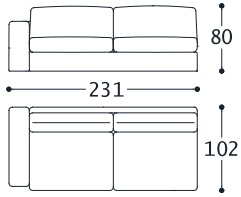

1BD2D3MSX

DREI SITZER MAXI SOFA ARMLEHNE LINKS
DREI SITZER MAXI SOFA ARMLEHNE
RECHTS

1BD2D3MSX		2BD2D3MSX	
1BD2D3MDX		2BD2D3MDX	
Cat.3	2.094,00	Cat.E	2.932,00
Cat.4	2.243,00	Cat.F	3.650,00
Cat.5	2.355,00	Cat.G	3.980,00
Cat.6	2.468,00	Cat.H	4.458,00
Cat.7	2.617,00	Cat.I	5.386,00
Cat.8	2.766,00	Cat.L	5.805,00
Cat.9	3.215,00	Cat.M	6.344,00
Cat.10	3.514,00		
Cat.11	3.850,00		
Cat.12	4.187,00		
Cat.13	4.598,00		

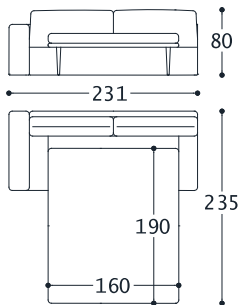

1BD2D3MSXSPP

DREI SITZER MAXI SOFA ARMLEHNE LINKS
MIT "SPECIAL" ELEKTROGESCHWEISSTEM
METALLROST UND
POLYURETHANMATRATZE
DREI SITZER MAXI SOFA ARMLEHNE
RECHTS MIT "SPECIAL"
ELEKTROGESCHWEISSTEM METALLROST
UND POLYURETHANMATRATZE

1BD2D3MSXSPP		2BD2D3MSXSPP	
1BD2D3MDXSPP		2BD2D3MDXSPP	
Cat.3	2.992,00	Cat.E	3.772,00
Cat.4	3.149,00	Cat.F	4.534,00
Cat.5	3.266,00	Cat.G	4.884,00
Cat.6	3.384,00	Cat.H	5.392,00
Cat.7	3.541,00	Cat.I	6.376,00
Cat.8	3.698,00	Cat.L	6.821,00
Cat.9	4.168,00	Cat.M	7.392,00
Cat.10	4.482,00		
Cat.11	4.835,00		
Cat.12	5.188,00		
Cat.13	5.620,00		

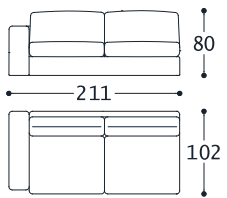

1BD2D3SX

DREI SITZER SOFA ARMLEHNE LINKS
DREI SITZER SOFA ARMLEHNE RECHTS

1BD2D3SX		2BD2D3SX	
1BD2D3DX		2BD2D3DX	
Cat.3	1.881,00	Cat.E	2.660,00
Cat.4	2.025,00	Cat.F	3.322,00
Cat.5	2.133,00	Cat.G	3.625,00
Cat.6	2.241,00	Cat.H	4.066,00
Cat.7	2.386,00	Cat.I	4.920,00
Cat.8	2.530,00	Cat.L	5.306,00
Cat.9	2.963,00	Cat.M	5.802,00
Cat.10	3.251,00		
Cat.11	3.576,00		
Cat.12	3.901,00		
Cat.13	4.298,00		

07 S74 N/E D. ORANGE 03.2023

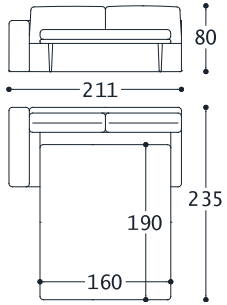

1BD2D3SXSP

DREI SITZER SOFA ARMLEHNE LINKS MIT "SPECIAL" ELEKTROGESCHWEISSTEM METALLROST UND POLYURETHANMATRATZE
DREI SITZER SOFA ARMLEHNE RECHTS MIT "SPECIAL" ELEKTROGESCHWEISSTEM METALLROST UND POLYURETHANMATRATZE

1BD2D3SXSP		2BD2D3SXSP	
1BD2D3DXSP		2BD2D3DXSP	
Cat.3	2.878,00	Cat.E	3.579,00
Cat.4	3.028,00	Cat.F	4.240,00
Cat.5	3.141,00	Cat.G	4.543,00
Cat.6	3.253,00	Cat.H	4.984,00
Cat.7	3.403,00	Cat.I	5.838,00
Cat.8	3.554,00	Cat.L	6.224,00
Cat.9	4.004,00	Cat.M	6.720,00
Cat.10	4.305,00		
Cat.11	4.643,00		
Cat.12	4.981,00		
Cat.13	5.394,00		

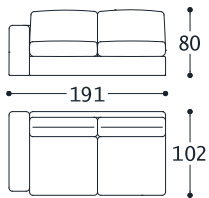

1BD2D2MSX

ZWEI SITZER MAXI SOFA ARMLEHNE LINKS
ZWEI SITZER MAXI SOFA ARMLEHNE RECHTS

1BD2D2MSX		2BD2D2MSX	
1BD2D2MDX		2BD2D2MDX	
Cat.3	1.694,00	Cat.E	2.387,00
Cat.4	1.837,00	Cat.F	2.991,00
Cat.5	1.945,00	Cat.G	3.268,00
Cat.6	2.052,00	Cat.H	3.671,00
Cat.7	2.196,00	Cat.I	4.452,00
Cat.8	2.339,00	Cat.L	4.805,00
Cat.9	2.769,00	Cat.M	5.258,00
Cat.10	3.056,00		
Cat.11	3.379,00		
Cat.12	3.702,00		
Cat.13	4.096,00		

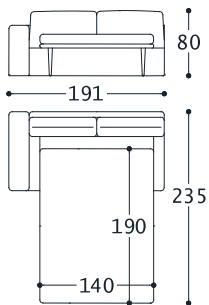

1BD2D2MSXSPP

ZWEI SITZER MAXI SOFA ARMLEHNE LINKS MIT "SPECIAL" ELEKTROGESCHWEISSTEM METALLROST UND POLYURETHANMATRATZE
ZWEI SITZER MAXI SOFA ARMLEHNE RECHTS MIT "SPECIAL" ELEKTROGESCHWEISSTEM METALLROST UND POLYURETHANMATRATZE

1BD2D2MSXSPP		2BD2D2MSXSPP	
1BD2D2MDXSPP		2BD2D2MDXSPP	
Cat.3	2.756,00	Cat.E	3.372,00
Cat.4	2.900,00	Cat.F	3.965,00
Cat.5	3.009,00	Cat.G	4.237,00
Cat.6	3.117,00	Cat.H	4.632,00
Cat.7	3.261,00	Cat.I	5.397,00
Cat.8	3.405,00	Cat.L	5.743,00
Cat.9	3.838,00	Cat.M	6.187,00
Cat.10	4.127,00		
Cat.11	4.452,00		
Cat.12	4.776,00		
Cat.13	5.173,00		

07 S74 N/E D. ORANGE 03.2023

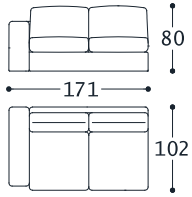

1BD2D2SX

ZWEI SITZER SOFA ARMLEHNE LINKS
ZWEI SITZER SOFA ARMLEHNE RECHTS

1BD2D2SX		2BD2D2SX	
1BD2D2DX		2BD2D2DX	
Cat.3	1.619,00	Cat.E	2.229,00
Cat.4	1.757,00	Cat.F	2.776,00
Cat.5	1.861,00	Cat.G	3.027,00
Cat.6	1.965,00	Cat.H	3.392,00
Cat.7	2.103,00	Cat.I	4.099,00
Cat.8	2.242,00	Cat.L	4.419,00
Cat.9	2.657,00	Cat.M	4.829,00
Cat.10	2.933,00		
Cat.11	3.245,00		
Cat.12	3.556,00		
Cat.13	3.937,00		

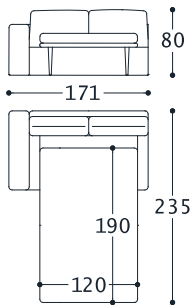

1BD2D2SXSP

ZWEI SITZER SOFA ARMLEHNE LINKS MIT
"SPECIAL" ELEKTROGESCHWEISSTEM
METALLROST UND
POLYURETHANMATRATZE
ZWEI SITZER SOFA ARMLEHNE RECHTS MIT
"SPECIAL" ELEKTROGESCHWEISSTEM
METALLROST UND
POLYURETHANMATRATZE

1BD2D2SXSP		2BD2D2SXSP	
1BD2D2DXSP		2BD2D2DXSP	
Cat.3	2.520,00	Cat.E	3.106,00
Cat.4	2.651,00	Cat.F	3.654,00
Cat.5	2.749,00	Cat.G	3.905,00
Cat.6	2.847,00	Cat.H	4.270,00
Cat.7	2.978,00	Cat.I	4.977,00
Cat.8	3.109,00	Cat.L	5.296,00
Cat.9	3.502,00	Cat.M	5.707,00
Cat.10	3.764,00		
Cat.11	4.059,00		
Cat.12	4.353,00		
Cat.13	4.713,00		

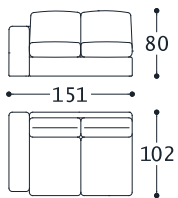

1BD2D2SSX

ZWEI SITZER SMALL SOFA ARMLEHNE LINKS
ZWEI SITZER SMALL SOFA ARMLEHNE
RECHTS

1BD2D2SSX		2BD2D2SSX	
1BD2D2SDX		2BD2D2SDX	
Cat.3	1.484,00	Cat.E	2.074,00
Cat.4	1.603,00	Cat.F	2.565,00
Cat.5	1.693,00	Cat.G	2.790,00
Cat.6	1.782,00	Cat.H	3.117,00
Cat.7	1.901,00	Cat.I	3.751,00
Cat.8	2.020,00	Cat.L	4.037,00
Cat.9	2.378,00	Cat.M	4.405,00
Cat.10	2.616,00		
Cat.11	2.884,00		
Cat.12	3.152,00		
Cat.13	3.480,00		

07 S74 N/E D. ORANGE 03.2023

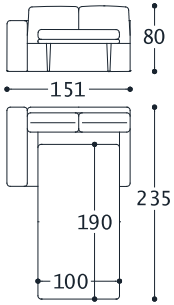

1BD2D2SSXSPP

ZWEI SITZER SMALL SOFA ARMLEHNE LINKS
MIT "SPECIAL" ELEKTROGESCHWEISSTEM
METALLROST UND
POLYURETHANMATRATZE
ZWEI SITZER SMALL SOFA ARMLEHNE
RECHTS MIT "SPECIAL"
ELEKTROGESCHWEISSTEM METALLROST
UND POLYURETHANMATRATZE

1BD2D2SSXSPP		2BD2D2SSXSPP	
1BD2D2SDXSPP		2BD2D2SDXSPP	
Cat.3	2.327,00	Cat.E	2.886,00
Cat.4	2.443,00	Cat.F	3.377,00
Cat.5	2.529,00	Cat.G	3.602,00
Cat.6	2.616,00	Cat.H	3.929,00
Cat.7	2.731,00	Cat.I	4.563,00
Cat.8	2.847,00	Cat.L	4.849,00
Cat.9	3.193,00	Cat.M	5.217,00
Cat.10	3.424,00		
Cat.11	3.684,00		
Cat.12	3.943,00		
Cat.13	4.261,00		

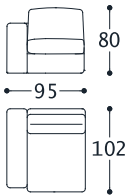

1BD2PSX

SESSEL ARMLEHNE LINKS
SESSEL ARMLEHNE RECHTS

1BD2PSX		2BD2PSX	
1BD2PDX		2BD2PDX	
Cat.3	1.021,00	Cat.E	1.412,00
Cat.4	1.110,00	Cat.F	1.745,00
Cat.5	1.176,00	Cat.G	1.897,00
Cat.6	1.242,00	Cat.H	2.119,00
Cat.7	1.330,00	Cat.I	2.549,00
Cat.8	1.418,00	Cat.L	2.743,00
Cat.9	1.682,00	Cat.M	2.993,00
Cat.10	1.858,00		
Cat.11	2.056,00		
Cat.12	2.254,00		
Cat.13	2.496,00		

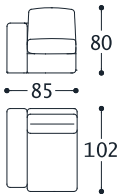

1BD2PSSX

SMALL SESSEL ARMLEHNE LINKS
SMALL SESSEL ARMLEHNE RECHTS

1BD2PSSX		2BD2PSSX	
1BD2PSDX		2BD2PSDX	
Cat.3	965,00	Cat.E	1.369,00
Cat.4	1.046,00	Cat.F	1.689,00
Cat.5	1.106,00	Cat.G	1.835,00
Cat.6	1.166,00	Cat.H	2.048,00
Cat.7	1.247,00	Cat.I	2.461,00
Cat.8	1.328,00	Cat.L	2.648,00
Cat.9	1.570,00	Cat.M	2.888,00
Cat.10	1.731,00		
Cat.11	1.913,00		
Cat.12	2.094,00		
Cat.13	2.316,00		

07 S74 N/E D. ORANGE 03.2023

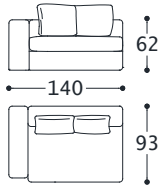

1BD2JSX

JOLLY ELEMENT ARMLEHNE LINKS (2
LOSSE JOLLY RÜCKENKISSEN INKLUSIV)
JOLLY ELEMENT ARMLEHNE RECHTS (2
LOSE JOLLY RÜCKENKISSEN INKLUSIV)

1BD2JSX		2BD2JSX	
1BD2JDX		2BD2JDX	
Cat.3	1.451,00	Cat.E	2.139,00
Cat.4	1.554,00	Cat.F	2.690,00
Cat.5	1.631,00	Cat.G	2.943,00
Cat.6	1.708,00	Cat.H	3.311,00
Cat.7	1.811,00	Cat.I	4.024,00
Cat.8	1.914,00	Cat.L	4.346,00
Cat.9	2.222,00	Cat.M	4.760,00
Cat.10	2.428,00		
Cat.11	2.660,00		
Cat.12	2.891,00		
Cat.13	3.174,00		

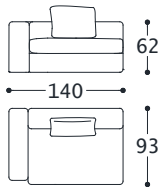

1BD2J2SX

JOLLY ELEMENT 2 ARMLEHNE LINKS (1
LOSER SPECIAL RÜCKENKISSEN INKLUSIV)
JOLLY ELEMENT 2 ARMLEHNE RECHTS (1
LOSER SPECIAL RÜCKENKISSEN INKLUSIV)

1BD2J2SX		2BD2J2SX	
1BD2J2DX		2BD2J2DX	
Cat.3	1.621,00	Cat.E	2.277,00
Cat.4	1.726,00	Cat.F	2.817,00
Cat.5	1.805,00	Cat.G	3.065,00
Cat.6	1.883,00	Cat.H	3.425,00
Cat.7	1.989,00	Cat.I	4.123,00
Cat.8	2.094,00	Cat.L	4.439,00
Cat.9	2.409,00	Cat.M	4.844,00
Cat.10	2.619,00		
Cat.11	2.855,00		
Cat.12	3.092,00		
Cat.13	3.381,00		

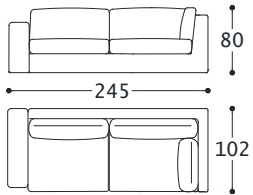

1BD2ANG3SX

DREI SITZER ECKELEMENT ARMLEHNE LINKS
DREI SITZER ECKELEMENT ARMLEHNE
RECHTS

1BD2ANG3SX		2BD2ANG3SX	
1BD2ANG3DX		2BD2ANG3DX	
Cat.3	2.260,00	Cat.E	3.300,00
Cat.4	2.447,00	Cat.F	4.167,00
Cat.5	2.587,00	Cat.G	4.565,00
Cat.6	2.728,00	Cat.H	5.143,00
Cat.7	2.915,00	Cat.I	6.263,00
Cat.8	3.102,00	Cat.L	6.769,00
Cat.9	3.664,00	Cat.M	7.419,00
Cat.10	4.038,00		
Cat.11	4.459,00		
Cat.12	4.881,00		
Cat.13	5.396,00		

07 S74 N/E D. ORANGE 03.2023

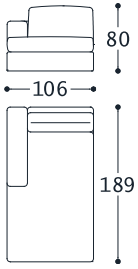

1BD2DORMXSX

MAXI DORMEUSE ARMLEHNE LINKS
MAXI DORMEUSE ARMLEHNE RECHTS

1BD2DORMXSX		2BD2DORMXSX	
1BD2DORMXDX		2BD2DORMXDX	
Cat.3	1.776,00	Cat.E	2.453,00
Cat.4	1.895,00	Cat.F	3.036,00
Cat.5	1.985,00	Cat.G	3.303,00
Cat.6	2.074,00	Cat.H	3.691,00
Cat.7	2.193,00	Cat.I	4.444,00
Cat.8	2.312,00	Cat.L	4.783,00
Cat.9	2.670,00	Cat.M	5.220,00
Cat.10	2.908,00		
Cat.11	3.176,00		
Cat.12	3.444,00		
Cat.13	3.772,00		

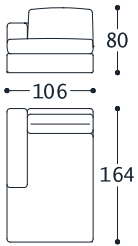

1BD2DORMSX

DORMEUSE ARMLEHNE LINKS
DORMEUSE ARMLEHNE RECHTS

1BD2DORMSX		2BD2DORMSX	
1BD2DORMDX		2BD2DORMDX	
Cat.3	1.539,00	Cat.E	2.187,00
Cat.4	1.651,00	Cat.F	2.725,00
Cat.5	1.735,00	Cat.G	2.972,00
Cat.6	1.819,00	Cat.H	3.332,00
Cat.7	1.930,00	Cat.I	4.027,00
Cat.8	2.042,00	Cat.L	4.342,00
Cat.9	2.377,00	Cat.M	4.746,00
Cat.10	2.601,00		
Cat.11	2.852,00		
Cat.12	3.104,00		
Cat.13	3.411,00		

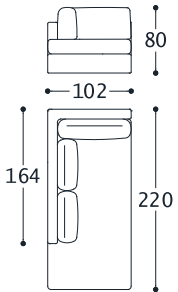

1BD2MERSX

MERIDIENNE LINKS
MERIDIENNE RECHTS

1BD2MERSX		2BD2MERSX	
1BD2MERDX		2BD2MERDX	
Cat.3	2.069,00	Cat.E	2.912,00
Cat.4	2.254,00	Cat.F	3.628,00
Cat.5	2.393,00	Cat.G	3.956,00
Cat.6	2.532,00	Cat.H	4.433,00
Cat.7	2.717,00	Cat.I	5.358,00
Cat.8	2.902,00	Cat.L	5.776,00
Cat.9	3.457,00	Cat.M	6.313,00
Cat.10	3.827,00		
Cat.11	4.243,00		
Cat.12	4.659,00		
Cat.13	5.168,00		

07 S74 N/E D. ORANGE 03.2023

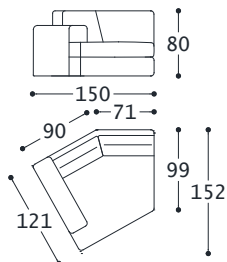

1BD2TRSX

ENDELEMENT LINKS
ENDELEMENT RECHTS

1BD2TRSX		2BD2TRSX	
1BD2TRDX		2BD2TRDX	
Cat.3	1.740,00	Cat.E	2.381,00
Cat.4	1.873,00	Cat.F	3.007,00
Cat.5	1.972,00	Cat.G	3.294,00
Cat.6	2.072,00	Cat.H	3.711,00
Cat.7	2.205,00	Cat.I	4.520,00
Cat.8	2.338,00	Cat.L	4.885,00
Cat.9	2.737,00	Cat.M	5.355,00
Cat.10	3.003,00		
Cat.11	3.303,00		
Cat.12	3.602,00		
Cat.13	3.968,00		

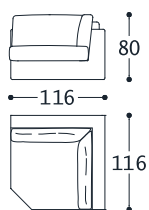

1BD2AR

ECKELEMENT

1BD2AR		2BD2AR	
Cat.3	1.334,00	Cat.E	2.098,00
Cat.4	1.457,00	Cat.F	2.607,00
Cat.5	1.548,00	Cat.G	2.839,00
Cat.6	1.640,00	Cat.H	3.178,00
Cat.7	1.762,00	Cat.I	3.834,00
Cat.8	1.884,00	Cat.L	4.131,00
Cat.9	2.250,00	Cat.M	4.512,00
Cat.10	2.494,00		
Cat.11	2.769,00		
Cat.12	3.044,00		
Cat.13	3.380,00		

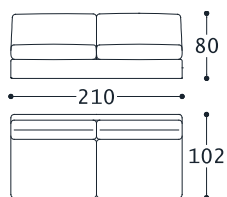

1BD2D3M1

ZENTRAL DREI SITZER MAXI SOFA

1BD2D3M1		2BD2D3M1	
Cat.3	1.912,00	Cat.E	2.639,00
Cat.4	2.043,00	Cat.F	3.283,00
Cat.5	2.142,00	Cat.G	3.578,00
Cat.6	2.240,00	Cat.H	4.008,00
Cat.7	2.371,00	Cat.I	4.839,00
Cat.8	2.502,00	Cat.L	5.215,00
Cat.9	2.895,00	Cat.M	5.698,00
Cat.10	3.157,00		
Cat.11	3.451,00		
Cat.12	3.746,00		
Cat.13	4.106,00		

07 S74 N/E D. ORANGE 03.2023

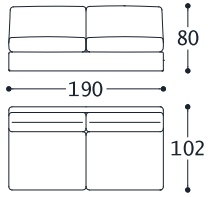

1BD2D31

ZENTRAL DREI SITZER SOFA

1BD2D31		2BD2D31	
Cat.3	1.713,00	Cat.E	2.359,00
Cat.4	1.844,00	Cat.F	2.946,00
Cat.5	1.942,00	Cat.G	3.215,00
Cat.6	2.041,00	Cat.H	3.606,00
Cat.7	2.172,00	Cat.I	4.365,00
Cat.8	2.303,00	Cat.L	4.707,00
Cat.9	2.696,00	Cat.M	5.147,00
Cat.10	2.958,00		
Cat.11	3.252,00		
Cat.12	3.547,00		
Cat.13	3.907,00		

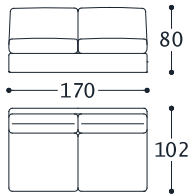

1BD2D2M1

ZENTRAL ZWEI SITZER MAXI SOFA

1BD2D2M1		2BD2D2M1	
Cat.3	1.642,00	Cat.E	2.109,00
Cat.4	1.773,00	Cat.F	2.639,00
Cat.5	1.872,00	Cat.G	2.882,00
Cat.6	1.970,00	Cat.H	3.236,00
Cat.7	2.101,00	Cat.I	3.920,00
Cat.8	2.232,00	Cat.L	4.229,00
Cat.9	2.625,00	Cat.M	4.627,00
Cat.10	2.887,00		
Cat.11	3.181,00		
Cat.12	3.476,00		
Cat.13	3.836,00		

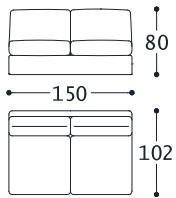

1BD2D21

ZENTRAL ZWEI SITZER SOFA

1BD2D21		2BD2D21	
Cat.3	1.444,00	Cat.E	1.957,00
Cat.4	1.567,00	Cat.F	2.430,00
Cat.5	1.659,00	Cat.G	2.647,00
Cat.6	1.751,00	Cat.H	2.962,00
Cat.7	1.874,00	Cat.I	3.573,00
Cat.8	1.997,00	Cat.L	3.849,00
Cat.9	2.365,00	Cat.M	4.204,00
Cat.10	2.611,00		
Cat.11	2.887,00		
Cat.12	3.164,00		
Cat.13	3.501,00		

07 S74 N/E D. ORANGE 03.2023

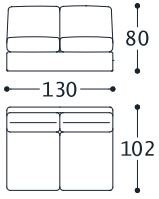

1BD2D2S1

ZENTRAL ZWEI SITZER SMALL SOFA

1BD2D2S1		2BD2D2S1	
Cat.3	1.312,00	Cat.E	1.814,00
Cat.4	1.417,00	Cat.F	2.230,00
Cat.5	1.496,00	Cat.G	2.421,00
Cat.6	1.575,00	Cat.H	2.698,00
Cat.7	1.680,00	Cat.I	3.236,00
Cat.8	1.785,00	Cat.L	3.478,00
Cat.9	2.100,00	Cat.M	3.790,00
Cat.10	2.310,00		
Cat.11	2.547,00		
Cat.12	2.783,00		
Cat.13	3.072,00		

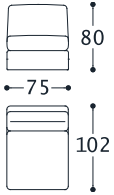

1BD2P1

ZENTRAL SESSEL

1BD2P1		2BD2P1	
Cat.3	859,00	Cat.E	1.263,00
Cat.4	933,00	Cat.F	1.583,00
Cat.5	988,00	Cat.G	1.730,00
Cat.6	1.044,00	Cat.H	1.943,00
Cat.7	1.118,00	Cat.I	2.356,00
Cat.8	1.192,00	Cat.L	2.542,00
Cat.9	1.414,00	Cat.M	2.782,00
Cat.10	1.562,00		
Cat.11	1.728,00		
Cat.12	1.895,00		
Cat.13	2.098,00		

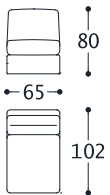

1BD2PS1

ZENTRAL SMALL SESSEL

1BD2PS1		2BD2PS1	
Cat.3	785,00	Cat.E	1.212,00
Cat.4	851,00	Cat.F	1.523,00
Cat.5	901,00	Cat.G	1.666,00
Cat.6	951,00	Cat.H	1.873,00
Cat.7	1.018,00	Cat.I	2.275,00
Cat.8	1.084,00	Cat.L	2.456,00
Cat.9	1.284,00	Cat.M	2.689,00
Cat.10	1.417,00		
Cat.11	1.567,00		
Cat.12	1.717,00		
Cat.13	1.900,00		

07 S74 N/E D. ORANGE 03.2023

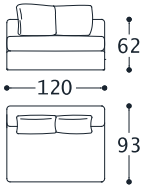

1BD2J1

ZENTRAL JOLLY ELEMENT 2 (2 "JOLLY"
RÜCKENKISSEN INKLUSIVE)

1BD2J1		2BD2J1	
Cat.3	1.263,00	Cat.E	1.934,00
Cat.4	1.348,00	Cat.F	2.454,00
Cat.5	1.412,00	Cat.G	2.693,00
Cat.6	1.475,00	Cat.H	3.040,00
Cat.7	1.560,00	Cat.I	3.712,00
Cat.8	1.646,00	Cat.L	4.015,00
Cat.9	1.901,00	Cat.M	4.406,00
Cat.10	2.071,00		
Cat.11	2.263,00		
Cat.12	2.454,00		
Cat.13	2.688,00		

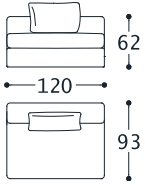

1BD2J21

ZENTRAL JOLLY ELEMENT 2 (1 "SPECIAL"
RÜCKENKISSEN "INKLUSIVE")

1BD2J21		2BD2J21	
Cat.3	1.433,00	Cat.E	2.077,00
Cat.4	1.521,00	Cat.F	2.586,00
Cat.5	1.586,00	Cat.G	2.819,00
Cat.6	1.652,00	Cat.H	3.158,00
Cat.7	1.739,00	Cat.I	3.816,00
Cat.8	1.826,00	Cat.L	4.113,00
Cat.9	2.088,00	Cat.M	4.494,00
Cat.10	2.263,00		
Cat.11	2.459,00		
Cat.12	2.656,00		
Cat.13	2.896,00		

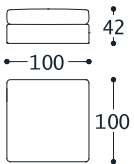

1BD2PFFJ

JOLLY HOCKER

1BD2PFFJ		2BD2PFFJ	
Cat.3	798,00	Cat.E	1.021,00
Cat.4	855,00	Cat.F	1.244,00
Cat.5	897,00	Cat.G	1.347,00
Cat.6	940,00	Cat.H	1.496,00
Cat.7	997,00	Cat.I	1.784,00
Cat.8	1.054,00	Cat.L	1.914,00
Cat.9	1.225,00	Cat.M	2.082,00
Cat.10	1.339,00		
Cat.11	1.467,00		
Cat.12	1.595,00		
Cat.13	1.752,00		

07 S74 N/E D. ORANGE 03.2023

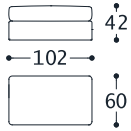

1BD2PFFR

RECHTECKIGER HOCKER

1BD2PFFR		2BD2PFFR	
Cat.3	670,00	Cat.E	968,00
Cat.4	711,00	Cat.F	1.192,00
Cat.5	741,00	Cat.G	1.294,00
Cat.6	772,00	Cat.H	1.443,00
Cat.7	812,00	Cat.I	1.731,00
Cat.8	853,00	Cat.L	1.862,00
Cat.9	975,00	Cat.M	2.029,00
Cat.10	1.057,00		
Cat.11	1.148,00		
Cat.12	1.240,00		
Cat.13	1.352,00		

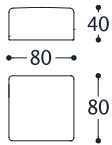

1BD2PF80

QUADRATISCHER HOCKER 80X80 CM

1BD2PF80		2BD2PF80	
Cat.3	479,00	Cat.E	676,00
Cat.4	511,00	Cat.F	808,00
Cat.5	535,00	Cat.G	868,00
Cat.6	559,00	Cat.H	955,00
Cat.7	590,00	Cat.I	1.125,00
Cat.8	622,00	Cat.L	1.202,00
Cat.9	718,00	Cat.M	1.300,00
Cat.10	781,00		
Cat.11	853,00		
Cat.12	925,00		
Cat.13	1.012,00		

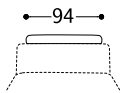

1BD2PTD3M

KOPFLEHNE 94 CM (GEEIGNET FÜR DREI SITZER MAXI SOFA)

1BD2PTD3M		2BD2PTD3M	
Cat.3	145,00	Cat.E	210,00
Cat.4	157,00	Cat.F	265,00
Cat.5	166,00	Cat.G	290,00
Cat.6	174,00	Cat.H	326,00
Cat.7	186,00	Cat.I	397,00
Cat.8	198,00	Cat.L	429,00
Cat.9	234,00	Cat.M	470,00
Cat.10	257,00		
Cat.11	284,00		
Cat.12	311,00		
Cat.13	343,00		

07 S74 N/E D. ORANGE 03.2023

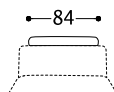

1BD2PTD3

KOPFLEHNE 84 CM (GEEIGNET FÜR DREI SITZER SOFA UND DREI SITZER ECKELEMENT)

1BD2PTD3		2BD2PTD3	
Cat.3	142,00	Cat.E	205,00
Cat.4	153,00	Cat.F	260,00
Cat.5	162,00	Cat.G	285,00
Cat.6	171,00	Cat.H	322,00
Cat.7	183,00	Cat.I	392,00
Cat.8	195,00	Cat.L	424,00
Cat.9	230,00	Cat.M	465,00
Cat.10	254,00		
Cat.11	281,00		
Cat.12	307,00		
Cat.13	340,00		

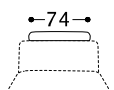

1BD2PTD2M

KOPFLEHNE 74 CM (FÜR ZWEI SITZER MAXI SOFA UND DORMEUSE)

1BD2PTD2M		2BD2PTD2M	
Cat.3	137,00	Cat.E	186,00
Cat.4	148,00	Cat.F	230,00
Cat.5	157,00	Cat.G	250,00
Cat.6	166,00	Cat.H	279,00
Cat.7	178,00	Cat.I	335,00
Cat.8	190,00	Cat.L	361,00
Cat.9	225,00	Cat.M	394,00
Cat.10	249,00		
Cat.11	276,00		
Cat.12	302,00		
Cat.13	335,00		

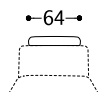

1BD2PTD2

KOPFLEHNE 64 CM (GEEIGNET FÜR SESSEL, ZWEI SITZER SOFA, ZWEI SITZER SMALL SOFA, MERIDIENNE UND ENDELEMENT)

1BD2PTD2		2BD2PTD2	
Cat.3	134,00	Cat.E	182,00
Cat.4	146,00	Cat.F	225,00
Cat.5	154,00	Cat.G	245,00
Cat.6	163,00	Cat.H	275,00
Cat.7	175,00	Cat.I	331,00
Cat.8	187,00	Cat.L	357,00
Cat.9	223,00	Cat.M	390,00
Cat.10	246,00		
Cat.11	273,00		
Cat.12	299,00		
Cat.13	332,00		

07 S74 N/E D. ORANGE 03.2023

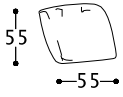

1BD2CJ

RÜCKENKISSEN JOLLY

1BD2CJ		2BD2CJ	
Cat.3	92,00	Cat.E	133,00
Cat.4	104,00	Cat.F	190,00
Cat.5	113,00	Cat.G	216,00
Cat.6	122,00	Cat.H	254,00
Cat.7	134,00	Cat.I	328,00
Cat.8	146,00	Cat.L	361,00
Cat.9	181,00	Cat.M	404,00
Cat.10	205,00		
Cat.11	231,00		
Cat.12	258,00		
Cat.13	291,00		

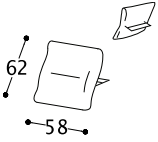

1BD2CSS

KISSEN SPECIAL

1BD2CSS		2BD2CSS	
Cat.3	339,00	Cat.E	377,00
Cat.4	364,00	Cat.F	454,00
Cat.5	383,00	Cat.G	489,00
Cat.6	402,00	Cat.H	540,00
Cat.7	427,00	Cat.I	639,00
Cat.8	452,00	Cat.L	684,00
Cat.9	528,00	Cat.M	741,00
Cat.10	578,00		
Cat.11	635,00		
Cat.12	691,00		
Cat.13	760,00		

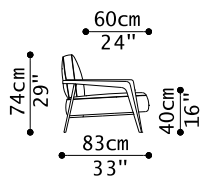

07 S74 N/E D. ORANGE 03.2023

VERSION IM ABZIEHBAREN STOFF UND BEZUG MIT EINEM EINZIGEN STOFF. GESTREIFTE STOFFE ODER DIE MIT MUSTERN, DIE GETROFFEN WERDEN MUESSEN, PASSEN ZU DIESEM MODELL. MODELL AUS KUNSTLEDER NICHT VERFÜGBAR. STRUKTUR AUS METALL (Feinbearbeitung nach Wahl: FRENCH BRONZE, GUN METAL, POLIERT BRÜNIERT) UND AUS HOLZ MIT WAHL ZWISCHEN NUSSBAUM CANALETTO ODER DUNKLE EICHE.

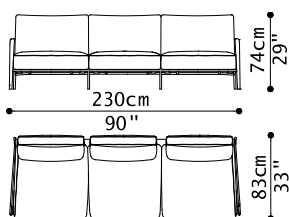

1CECD3NC

DREI SITZER SOFA-NUSSBAUMHOLZ
CANALETTO

1CECD3NC		2CECD3NC	
Cat.3	5.072,00	Cat.E	5.580,00
Cat.4	5.178,00	Cat.F	6.118,00
Cat.5	5.258,00	Cat.G	6.365,00
Cat.6	5.337,00	Cat.H	6.725,00
Cat.7	5.444,00	Cat.I	7.420,00
Cat.8	5.550,00	Cat.L	7.735,00
Cat.9	5.868,00	Cat.M	8.139,00
Cat.10	6.081,00		
Cat.11	6.319,00		
Cat.12	6.558,00		
Cat.13	6.850,00		

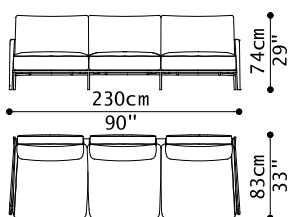

1CECD3W

DREI SITZER SOFA-DUNKLE EICHE

1CECD3W		2CECD3W	
Cat.3	5.022,00	Cat.E	5.530,00
Cat.4	5.128,00	Cat.F	6.069,00
Cat.5	5.208,00	Cat.G	6.316,00
Cat.6	5.288,00	Cat.H	6.675,00
Cat.7	5.394,00	Cat.I	7.371,00
Cat.8	5.500,00	Cat.L	7.685,00
Cat.9	5.818,00	Cat.M	8.089,00
Cat.10	6.031,00		
Cat.11	6.270,00		
Cat.12	6.508,00		
Cat.13	6.800,00		

07 S74 N/E D. ORANGE 03.2023

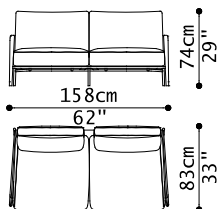

1CECD2NC

ZWEI SITZER SOFA-NUSSBAUMHOLZ CANALETTO

1CECD2NC		2CECD2NC	
Cat.3	3.586,00	Cat.E	3.925,00
Cat.4	3.658,00	Cat.F	4.283,00
Cat.5	3.712,00	Cat.G	4.446,00
Cat.6	3.766,00	Cat.H	4.685,00
Cat.7	3.838,00	Cat.I	5.147,00
Cat.8	3.910,00	Cat.L	5.356,00
Cat.9	4.126,00	Cat.M	5.624,00
Cat.10	4.270,00		
Cat.11	4.432,00		
Cat.12	4.594,00		
Cat.13	4.792,00		

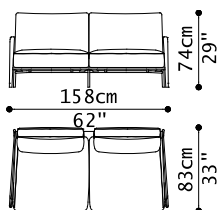

1CECD2W

ZWEI SITZER SOFA-DUNKLE EICHE

1CECD2W		2CECD2W	
Cat.3	3.536,00	Cat.E	3.875,00
Cat.4	3.608,00	Cat.F	4.233,00
Cat.5	3.662,00	Cat.G	4.397,00
Cat.6	3.716,00	Cat.H	4.635,00
Cat.7	3.788,00	Cat.I	5.097,00
Cat.8	3.860,00	Cat.L	5.306,00
Cat.9	4.076,00	Cat.M	5.574,00
Cat.10	4.220,00		
Cat.11	4.382,00		
Cat.12	4.544,00		
Cat.13	4.742,00		

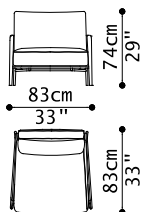

1CECPNC

SESSEL-NUSSBAUMHOLZ CANALETTO

1CECPNC		2CECPNC	
Cat.3	1.932,00	Cat.E	2.051,00
Cat.4	1.960,00	Cat.F	2.200,00
Cat.5	1.980,00	Cat.G	2.268,00
Cat.6	2.001,00	Cat.H	2.368,00
Cat.7	2.029,00	Cat.I	2.561,00
Cat.8	2.056,00	Cat.L	2.648,00
Cat.9	2.139,00	Cat.M	2.760,00
Cat.10	2.195,00		
Cat.11	2.257,00		
Cat.12	2.319,00		
Cat.13	2.395,00		

07 S74 N/E D. ORANGE 03.2023

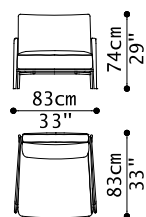

SESSEL-DUNKLE EICHE

1CECPW

1CECPW		2CECPW	
Cat.3	1.885,00	Cat.E	2.004,00
Cat.4	1.912,00	Cat.F	2.153,00
Cat.5	1.933,00	Cat.G	2.221,00
Cat.6	1.954,00	Cat.H	2.321,00
Cat.7	1.981,00	Cat.I	2.513,00
Cat.8	2.009,00	Cat.L	2.600,00
Cat.9	2.092,00	Cat.M	2.712,00
Cat.10	2.147,00		
Cat.11	2.209,00		
Cat.12	2.272,00		
Cat.13	2.348,00		

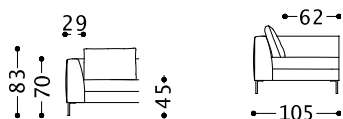

07 S74 N/E D. ORANGE 03.2023

DIE STOFF-VERSION IST ABNEHMBAR UND MAN KANN RÜCKENKISSEN, SITZKISSEN UND CHASSIS MIT VERSCHIEDENEN STOFFEN BEZIEHEN. GESTREIFTE STOFFE ODER STOFFE MIT MUSTERN EIGNEN SICH NUR FÜR RÜCKENKISSEN. LIEFERBAR AUCH AUS KUNSTLEDER (NICHT ABNEHMBAR). IMMER GEWÜNSCHTE FÜSSE ANGEBEN, DIE BESTELNUMMERN SIND FOLGENDE: KODE PD10083 VERCHROMTE METALL FÜSSE, H. 17 CM - KODE PD10085 MATT-GRAU FÜSSE, H. 17 CM. WENN NICHT ANGEGBEN, WERDEN STANDARD FÜSSE KODE PD10083 GELIEFERT.

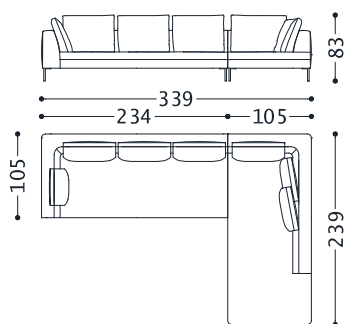

01CL2C1

1 MAXI CHAISE LONGUE ARMLEHNE RECHTS
1 DREI SITZER SOFA ARMLEHNE LINKS

01CL2C1		02CL2C1	
Cat.3	4.392,00	Cat.E	6.402,00
Cat.4	4.663,00	Cat.F	8.087,00
Cat.5	4.867,00	Cat.G	8.859,00
Cat.6	5.070,00	Cat.H	9.983,00
Cat.7	5.342,00	Cat.I	12.159,00
Cat.8	5.613,00	Cat.L	13.142,00
Cat.9	6.427,00	Cat.M	14.405,00
Cat.10	6.969,00		
Cat.11	7.579,00		
Cat.12	8.189,00		
Cat.13	8.936,00		

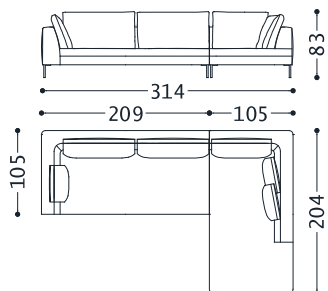

01CL2C2

1 CHAISE LONGUE ARMLEHNE RECHTS
1 ZWEI SITZER MAXI SOFA ARMLEHNE LINKS

01CL2C2		02CL2C2	
Cat.3	3.801,00	Cat.E	5.491,00
Cat.4	4.054,00	Cat.F	6.918,00
Cat.5	4.244,00	Cat.G	7.571,00
Cat.6	4.435,00	Cat.H	8.523,00
Cat.7	4.688,00	Cat.I	10.367,00
Cat.8	4.942,00	Cat.L	11.198,00
Cat.9	5.702,00	Cat.M	12.269,00
Cat.10	6.209,00		
Cat.11	6.779,00		
Cat.12	7.349,00		
Cat.13	8.047,00		

COLLINS 2

Währung: EUR

alberta
Made in Italy

07 S74 N/E D. ORANGE 03.2023

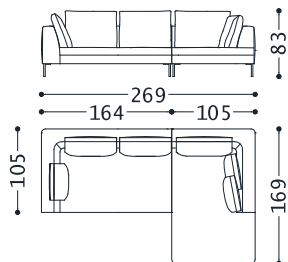

01CL2C3

1 SMALL CHAISE LONGUE RECHTS
1 ZWEI SITZER SOFA ARMLEHNE LINKS

01CL2C3		02CL2C3	
Cat.3	3.375,00	Cat.E	4.923,00
Cat.4	3.595,00	Cat.F	6.186,00
Cat.5	3.760,00	Cat.G	6.765,00
Cat.6	3.924,00	Cat.H	7.607,00
Cat.7	4.145,00	Cat.I	9.238,00
Cat.8	4.365,00	Cat.L	9.975,00
Cat.9	5.025,00	Cat.M	10.922,00
Cat.10	5.466,00		
Cat.11	5.961,00		
Cat.12	6.456,00		
Cat.13	7.061,00		

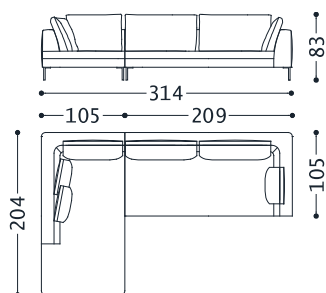

01CL2C4

1 CHAISE LONGUE ARMLEHNE LINKS
1 ZWEI SITZER MAXI SOFA ARMLEHNE RECHTS

01CL2C4		02CL2C4	
Cat.3	3.801,00	Cat.E	5.491,00
Cat.4	4.054,00	Cat.F	6.918,00
Cat.5	4.244,00	Cat.G	7.571,00
Cat.6	4.435,00	Cat.H	8.523,00
Cat.7	4.688,00	Cat.I	10.367,00
Cat.8	4.942,00	Cat.L	11.198,00
Cat.9	5.702,00	Cat.M	12.269,00
Cat.10	6.209,00		
Cat.11	6.779,00		
Cat.12	7.349,00		
Cat.13	8.047,00		

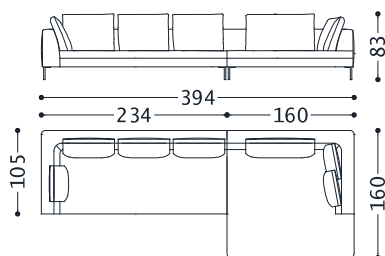

01CL2C5

1 LARGE CHAISE LONGUE ARMLEHNE RECHTS
1 DREI SITZER SOFA ARMLEHNE LINKS

01CL2C5		02CL2C5	
Cat.3	4.426,00	Cat.E	6.331,00
Cat.4	4.699,00	Cat.F	7.932,00
Cat.5	4.904,00	Cat.G	8.664,00
Cat.6	5.109,00	Cat.H	9.731,00
Cat.7	5.383,00	Cat.I	11.797,00
Cat.8	5.656,00	Cat.L	12.731,00
Cat.9	6.476,00	Cat.M	13.930,00
Cat.10	7.022,00		
Cat.11	7.637,00		
Cat.12	8.252,00		
Cat.13	9.005,00		

COLLINS 2

Währung: EUR

alberta
Made in Italy

07 S74 N/E D. ORANGE 03.2023

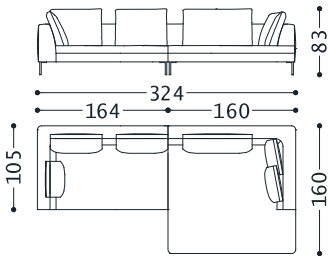

01CL2C6

1 LARGE CHAISE LONGUE ARMLEHNE RECHTS
1 ZWEI SITZER SOFA ARMLEHNE LINKS

01CL2C6	
Cat.3	3.915,00
Cat.4	4.153,00
Cat.5	4.331,00
Cat.6	4.509,00
Cat.7	4.747,00
Cat.8	4.985,00
Cat.9	5.698,00
Cat.10	6.174,00
Cat.11	6.709,00
Cat.12	7.244,00
Cat.13	7.899,00

02CL2C6	
Cat.E	5.555,00
Cat.F	6.934,00
Cat.G	7.565,00
Cat.H	8.484,00
Cat.I	10.263,00
Cat.L	11.068,00
Cat.M	12.101,00

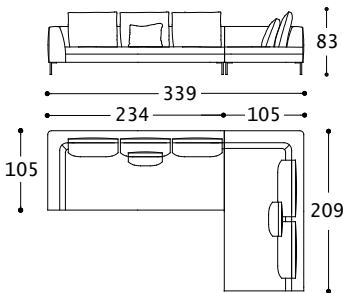

01CL2C7

1 ZWEI SITZER MAXI SOFA ARMLEHNE LINKS
1 DREI SITZER SOFA ARMLEHNE LINKS

01CL2C7	
Cat.3	4.066,00
Cat.4	4.331,00
Cat.5	4.530,00
Cat.6	4.730,00
Cat.7	4.996,00
Cat.8	5.261,00
Cat.9	6.058,00
Cat.10	6.588,00
Cat.11	7.186,00
Cat.12	7.783,00
Cat.13	8.514,00

02CL2C7	
Cat.E	5.859,00
Cat.F	7.374,00
Cat.G	8.067,00
Cat.H	9.077,00
Cat.I	11.034,00
Cat.L	11.917,00
Cat.M	13.053,00

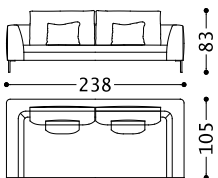

1CL2D3

DREI SITZER SOFA

1CL2D3	
Cat.3	2.315,00
Cat.4	2.467,00
Cat.5	2.582,00
Cat.6	2.696,00
Cat.7	2.849,00
Cat.8	3.002,00
Cat.9	3.460,00
Cat.10	3.765,00
Cat.11	4.108,00
Cat.12	4.452,00
Cat.13	4.872,00

2CL2D3	
Cat.E	3.309,00
Cat.F	4.165,00
Cat.G	4.558,00
Cat.H	5.129,00
Cat.I	6.235,00
Cat.L	6.734,00
Cat.M	7.376,00

07 S74 N/E D. ORANGE 03.2023

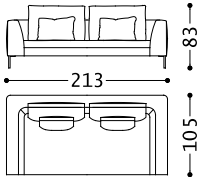

1CL2D2M

ZWEI SITZER MAXI SOFA

1CL2D2M		2CL2D2M	
Cat.3	2.097,00	Cat.E	2.993,00
Cat.4	2.243,00	Cat.F	3.754,00
Cat.5	2.352,00	Cat.G	4.102,00
Cat.6	2.461,00	Cat.H	4.609,00
Cat.7	2.607,00	Cat.I	5.591,00
Cat.8	2.752,00	Cat.L	6.035,00
Cat.9	3.189,00	Cat.M	6.605,00
Cat.10	3.480,00		
Cat.11	3.807,00		
Cat.12	4.135,00		
Cat.13	4.535,00		

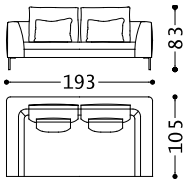

1CL2D2

ZWEI SITZER SOFA

1CL2D2		2CL2D2	
Cat.3	1.896,00	Cat.E	2.745,00
Cat.4	2.031,00	Cat.F	3.473,00
Cat.5	2.131,00	Cat.G	3.807,00
Cat.6	2.232,00	Cat.H	4.293,00
Cat.7	2.366,00	Cat.I	5.234,00
Cat.8	2.500,00	Cat.L	5.659,00
Cat.9	2.903,00	Cat.M	6.205,00
Cat.10	3.171,00		
Cat.11	3.473,00		
Cat.12	3.775,00		
Cat.13	4.144,00		

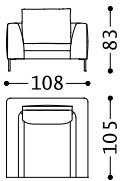

1CL2P

SESSEL

1CL2P		2CL2P	
Cat.3	1.226,00	Cat.E	1.669,00
Cat.4	1.308,00	Cat.F	2.072,00
Cat.5	1.369,00	Cat.G	2.256,00
Cat.6	1.431,00	Cat.H	2.525,00
Cat.7	1.512,00	Cat.I	3.045,00
Cat.8	1.594,00	Cat.L	3.280,00
Cat.9	1.839,00	Cat.M	3.582,00
Cat.10	2.002,00		
Cat.11	2.186,00		
Cat.12	2.370,00		
Cat.13	2.594,00		

07 S74 N/E D. ORANGE 03.2023

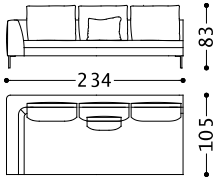

1CL2D3SX

DREI SITZER SOFA ARMLEHNE LINKS
DREI SITZER SOFA ARMLEHNE RECHTS

1CL2D3SX		2CL2D3SX	
1CL2D3DX		2CL2D3DX	
Cat.3	2.150,00	Cat.E	3.112,00
Cat.4	2.291,00	Cat.F	3.937,00
Cat.5	2.397,00	Cat.G	4.314,00
Cat.6	2.503,00	Cat.H	4.864,00
Cat.7	2.645,00	Cat.I	5.929,00
Cat.8	2.786,00	Cat.L	6.410,00
Cat.9	3.210,00	Cat.M	7.028,00
Cat.10	3.492,00		
Cat.11	3.810,00		
Cat.12	4.128,00		
Cat.13	4.517,00		

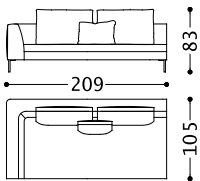

1CL2D2MSX

ZWEI SITZER MAXI SOFA ARMLEHNE LINKS
ZWEI SITZER MAXI SOFA ARMLEHNE
RECHTS

1CL2D2MSX		2CL2D2MSX	
1CL2D2MDX		2CL2D2MDX	
Cat.3	1.916,00	Cat.E	2.747,00
Cat.4	2.040,00	Cat.F	3.437,00
Cat.5	2.133,00	Cat.G	3.753,00
Cat.6	2.227,00	Cat.H	4.213,00
Cat.7	2.351,00	Cat.I	5.105,00
Cat.8	2.475,00	Cat.L	5.507,00
Cat.9	2.848,00	Cat.M	6.025,00
Cat.10	3.096,00		
Cat.11	3.376,00		
Cat.12	3.655,00		
Cat.13	3.997,00		

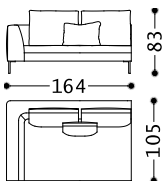

1CL2D2SX

ZWEI SITZER SOFA ARMLEHNE LINKS
ZWEI SITZER SOFA ARMLEHNE RECHTS

1CL2D2SX		2CL2D2SX	
1CL2D2DX		2CL2D2DX	
Cat.3	1.639,00	Cat.E	2.336,00
Cat.4	1.745,00	Cat.F	2.939,00
Cat.5	1.824,00	Cat.G	3.215,00
Cat.6	1.903,00	Cat.H	3.617,00
Cat.7	2.009,00	Cat.I	4.395,00
Cat.8	2.115,00	Cat.L	4.747,00
Cat.9	2.432,00	Cat.M	5.199,00
Cat.10	2.644,00		
Cat.11	2.882,00		
Cat.12	3.120,00		
Cat.13	3.411,00		

07 S74 N/E D. ORANGE 03.2023

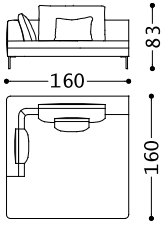

1CL2CHLLSX

LARGE CHAISE LONGUE ARMLEHNE LINKS
LARGE CHAISE LONGUE ARMLEHNE
RECHTS

1CL2CHLLSX		2CL2CHLLSX	
1CL2CHLLDX		2CL2CHLLDX	
Cat.3	2.276,00	Cat.E	3.219,00
Cat.4	2.408,00	Cat.F	3.995,00
Cat.5	2.507,00	Cat.G	4.350,00
Cat.6	2.606,00	Cat.H	4.867,00
Cat.7	2.738,00	Cat.I	5.868,00
Cat.8	2.870,00	Cat.L	6.321,00
Cat.9	3.266,00	Cat.M	6.902,00
Cat.10	3.530,00		
Cat.11	3.827,00		
Cat.12	4.124,00		
Cat.13	4.488,00		

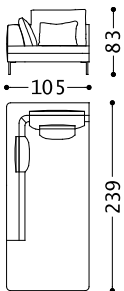

1CL2CHLMSX

MAXI CHAISE LONGUE ARMLEHNE LINKS
MAXI CHAISE LONGUE ARMLEHNE
RECHTS

1CL2CHLMSX		2CL2CHLMSX	
1CL2CHLMDX		2CL2CHLMDX	
Cat.3	2.242,00	Cat.E	3.290,00
Cat.4	2.372,00	Cat.F	4.150,00
Cat.5	2.470,00	Cat.G	4.545,00
Cat.6	2.567,00	Cat.H	5.119,00
Cat.7	2.697,00	Cat.I	6.230,00
Cat.8	2.827,00	Cat.L	6.732,00
Cat.9	3.217,00	Cat.M	7.377,00
Cat.10	3.477,00		
Cat.11	3.769,00		
Cat.12	4.061,00		
Cat.13	4.419,00		

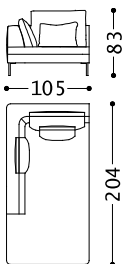

1CL2CHLSX

CHAISE LONGUE ARMLEHNE LINKS
CHAISE LONGUE ARMLEHNE RECHTS

1CL2CHLSX		2CL2CHLSX	
1CL2CHLDX		2CL2CHLDX	
Cat.3	1.885,00	Cat.E	2.744,00
Cat.4	2.014,00	Cat.F	3.481,00
Cat.5	2.111,00	Cat.G	3.818,00
Cat.6	2.208,00	Cat.H	4.310,00
Cat.7	2.337,00	Cat.I	5.262,00
Cat.8	2.467,00	Cat.L	5.691,00
Cat.9	2.854,00	Cat.M	6.244,00
Cat.10	3.113,00		
Cat.11	3.403,00		
Cat.12	3.694,00		
Cat.13	4.050,00		

07 S74 N/E D. ORANGE 03.2023

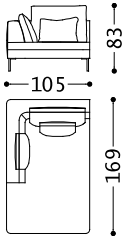

1CL2CHLSSX

SMALL CHAISE LONGUE LINKS
SMALL CHAISE LONGUE RECHTS

1CL2CHLSSX		2CL2CHLSSX	
1CL2CHLSDX		2CL2CHLSDX	
Cat.3	1.736,00	Cat.E	2.587,00
Cat.4	1.850,00	Cat.F	3.247,00
Cat.5	1.936,00	Cat.G	3.550,00
Cat.6	2.021,00	Cat.H	3.990,00
Cat.7	2.136,00	Cat.I	4.843,00
Cat.8	2.250,00	Cat.L	5.228,00
Cat.9	2.593,00	Cat.M	5.723,00
Cat.10	2.822,00		
Cat.11	3.079,00		
Cat.12	3.336,00		
Cat.13	3.650,00		

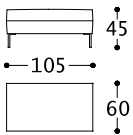

1CL2PFFR

RECHTECKIGER HOCKER

1CL2PFFR		2CL2PFFR	
Cat.3	767,00	Cat.E	996,00
Cat.4	820,00	Cat.F	1.188,00
Cat.5	859,00	Cat.G	1.275,00
Cat.6	899,00	Cat.H	1.403,00
Cat.7	951,00	Cat.I	1.651,00
Cat.8	1.004,00	Cat.L	1.763,00
Cat.9	1.162,00	Cat.M	1.906,00
Cat.10	1.267,00		
Cat.11	1.385,00		
Cat.12	1.503,00		
Cat.13	1.648,00		

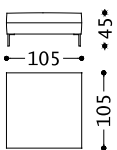

1CL2PFFQ

QUADRATISCHER HOCKER

1CL2PFFQ		2CL2PFFQ	
Cat.3	834,00	Cat.E	1.118,00
Cat.4	884,00	Cat.F	1.348,00
Cat.5	921,00	Cat.G	1.454,00
Cat.6	958,00	Cat.H	1.607,00
Cat.7	1.008,00	Cat.I	1.904,00
Cat.8	1.058,00	Cat.L	2.038,00
Cat.9	1.207,00	Cat.M	2.211,00
Cat.10	1.306,00		
Cat.11	1.418,00		
Cat.12	1.530,00		
Cat.13	1.667,00		

07 S74 N/E D. ORANGE 03.2023

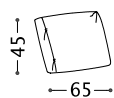

1CL2CR65

RECHTECKIGER KISSEN 65X45 CM

1CL2CR65		2CL2CR65	
Cat.3	112,00	Cat.E	174,00
Cat.4	129,00	Cat.F	229,00
Cat.5	141,00	Cat.G	255,00
Cat.6	153,00	Cat.H	291,00
Cat.7	170,00	Cat.I	363,00
Cat.8	186,00	Cat.L	395,00
Cat.9	235,00	Cat.M	437,00
Cat.10	268,00		
Cat.11	304,00		
Cat.12	341,00		
Cat.13	386,00		

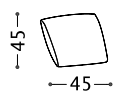

1CL2CQ45

QUADRATISCHER KISSEN AUS FEDER
45X45 CM

1CL2CQ45		2CL2CQ45	
Cat.3	83,00	Cat.E	121,00
Cat.4	92,00	Cat.F	164,00
Cat.5	100,00	Cat.G	183,00
Cat.6	107,00	Cat.H	212,00
Cat.7	117,00	Cat.I	267,00
Cat.8	127,00	Cat.L	292,00
Cat.9	157,00	Cat.M	324,00
Cat.10	177,00		
Cat.11	199,00		
Cat.12	222,00		
Cat.13	249,00		

BEZÜGE SIND NICHT ABNEHMBAR. DIESES MODELL KANN NUR MIT EINEM EINZELNEN STOFF BEZOGEN WERDEN. WIR EMPFEHLEN, UNIFARBIGE STOFFE ZU WÄHLEN. GESTREIFTE STOFFE ODER STOFFE MIT MUSTERN EIGNEN SICH NICHT FÜR DIESES MODELL. LIEFERBAR AUCH AUS KUNSTLEDER (NICHT ABNEHMBAR). DER BEZUG SCHLIESST AUCH DIE ARMLEHNEABDECKUNGEN EIN.

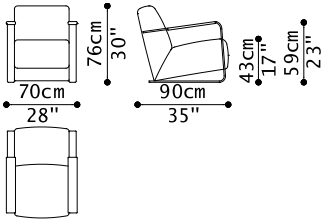

PMELT

SESSEL MIT BASIS UND ARMLEHNEN AUS VERCHROMTEM METALL (ZWEI ARMLEHNEN ABDECKUNGEN)

PMELT		PMPELL	
Cat.3	1.446,00	Cat.E	1.735,00
Cat.4	1.481,00	Cat.F	1.977,00
Cat.5	1.508,00	Cat.G	2.088,00
Cat.6	1.535,00	Cat.H	2.250,00
Cat.7	1.570,00	Cat.I	2.563,00
Cat.8	1.606,00	Cat.L	2.705,00
Cat.9	1.712,00	Cat.M	2.887,00
Cat.10	1.783,00		
Cat.11	1.863,00		
Cat.12	1.943,00		
Cat.13	2.041,00		

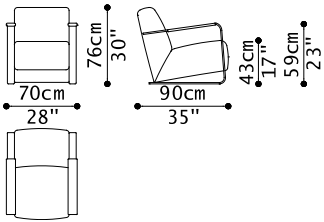

1ELTPNV

SESSEL MIT BASIS UND ARMLEHNEN AUS MATTSCHWARZ LACKIERT (ZWEI ARMLEHNEN ABDECKUNGEN)

1ELTPNV		2ELLPNV	
Cat.3	1.446,00	Cat.E	1.735,00
Cat.4	1.481,00	Cat.F	1.977,00
Cat.5	1.508,00	Cat.G	2.088,00
Cat.6	1.535,00	Cat.H	2.250,00
Cat.7	1.570,00	Cat.I	2.563,00
Cat.8	1.606,00	Cat.L	2.705,00
Cat.9	1.712,00	Cat.M	2.887,00
Cat.10	1.783,00		
Cat.11	1.863,00		
Cat.12	1.943,00		
Cat.13	2.041,00		

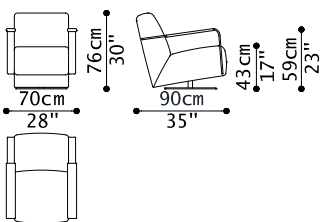

PMGRELT

DREHSESSEL MIT BASIS UND ARMLEHNEN AUS VERCHROMTEM METALL (ZWEI ARMLEHNEN ABDECKUNGEN)

PMGRELT		PMGRPELL	
Cat.3	1.498,00	Cat.E	1.803,00
Cat.4	1.534,00	Cat.F	2.059,00
Cat.5	1.561,00	Cat.G	2.176,00
Cat.6	1.587,00	Cat.H	2.346,00
Cat.7	1.623,00	Cat.I	2.677,00
Cat.8	1.658,00	Cat.L	2.826,00
Cat.9	1.765,00	Cat.M	3.018,00
Cat.10	1.836,00		
Cat.11	1.916,00		
Cat.12	1.996,00		
Cat.13	2.093,00		

07 S74 N/E D. ORANGE 03.2023

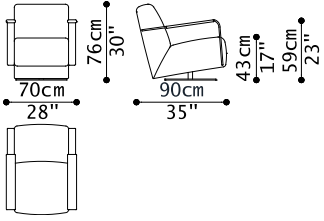

1ELTPGRNV

DREHSELSEL MIT BASIS UND ARMLEHNEN
AUS MATTSCHWARZ LACKIERT (ZWEI
ARMLEHNEN ABDECKUNGEN)

1ELTPGRNV		2ELLPGRNV	
Cat.3	1.498,00	Cat.E	1.803,00
Cat.4	1.534,00	Cat.F	2.059,00
Cat.5	1.561,00	Cat.G	2.176,00
Cat.6	1.587,00	Cat.H	2.346,00
Cat.7	1.623,00	Cat.I	2.677,00
Cat.8	1.658,00	Cat.L	2.826,00
Cat.9	1.765,00	Cat.M	3.018,00
Cat.10	1.836,00		
Cat.11	1.916,00		
Cat.12	1.996,00		
Cat.13	2.093,00		

07 S74 N/E D. ORANGE 03.2023

Auswahl Marmor: Mar.NATURAL DOVER WHITE (X1), Mar.MAGIC BROWN (X1), Mar.ARBESQUE PURPLE (X1), Mar.DAINO REALE (X2), Mar.MARQUINA BLACK (X2), Mar.EMPERADOR BROWN (X3), Mar.NATURAL TRAVERTINO (X3), Mar.CALACATTA WHITE (X4), Mar.VERDE ISSORIE (X4), Mar.CREAM CALACATTA (X4). LACKIERT BEARBEITUNG- FARBEN ZUR AUSWAHL: BORDEAUX, GREEN, BLUE, GREY, IVORY, DOVE GREY, MINK BROWN, RUST, MIST, CREAM, DARK BROWN, BURGUNDY, SNOW, ASH GREY. BASIS AUS METALL-Auswahl: FRENCH BRONZE, GUN METAL, POLIERT BRÜNIERT.

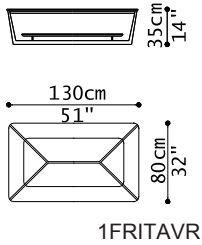

RECHTECKIGER COUCHTISCH 130X80
H.35 MIT HOHER TOP AUS MARMOR,
NIEDRIGER TOP LACKIERT, BASIS AUS
METALL

1FRITAVR	
X1	3.929,00
X2	2.975,00
X3	3.253,00
X4	3.929,00

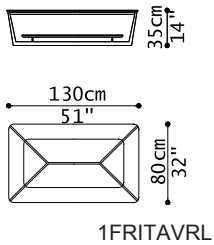

RECHTECKIGER COUCHTISCH 130X80
H.35 MIT HOHER TOP UND NIEDRIGER TOP
LACKIERT, BASIS AUS METALL

1FRITAVRL	
Z1	2.702,00

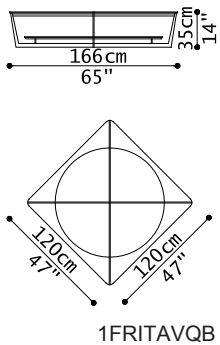

NIEDRIGER QUADRATISCHER
COUCHTISCH 120X120 H.35 MIT HOHER
TOP AUS MARMOR, NIEDRIGER TOP
LACKIERT, BASIS AUS METALL

1FRITAVQB	
X1	5.526,00
X2	3.984,00
X3	4.200,00
X4	5.359,00

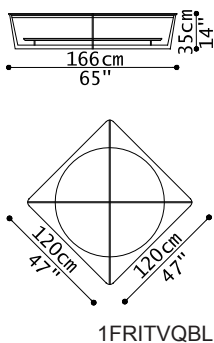

NIEDRIGER QUADRATISCHER
COUCHTISCH 120X120 H.35 MIT HOHER
TOP UND NIEDRIGER TOP LACKIERT, BASIS
AUS METALL

1FRITVQBL	
Z1	3.740,00

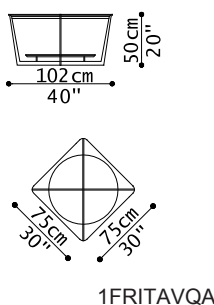

HOHER QUADRATISCHER COUCHTISCH
75X75 H.50 MIT HOHER TOP AUS
MARMOR, NIEDRIGER TOP LACKIERT,
BASIS AUS METALL

1FRITAVQA	
X1	2.961,00
X2	2.372,00
X3	2.514,00
X4	2.984,00

07 S74 N/E D. ORANGE 03.2023

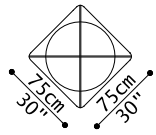
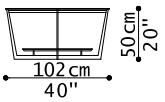

1FRITVQAL

HOHER QUADRATISCHER COUCHTISCH
75X75 H.50 MIT HOHER TOP UND
NIEDRIGER TOP LACKIERT, BASIS AUS
METALL

1FRITVQAL

Z1	2.169,00
----	----------

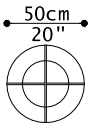
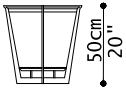

1FRITROT

RUNDTISCH Ø50 H.50 MIT HOHER TOP AUS
MARMOR, NIEDRIGER TOP LACKIERT,
BASIS AUS METALL

1FRITROT

X1	2.128,00
X2	1.617,00
X3	1.848,00
X4	2.140,00

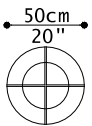
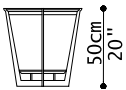

1FRITROTL

RUNDTISCH Ø50 H.50 MIT HOHER TOP
UND NIEDRIGER TOP LACKIERT, BASIS
AUS METALL

1FRITROTL

Z1	1.568,00
----	----------

ABNEHMBAR. GESTREIFTE STOFFE ODER STOFFE MIT MUSTERN EIGNEN SICH NICHT FÜR DIESES MODELL. MODELL AUS KUNSTLEDER NICHT VERFÜGBAR.

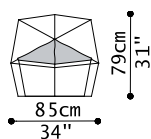

1 NIERENKISSEN
1 SESSEL

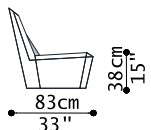

01GSPC1

01GSPC1		02GSPC1	
Cat.3	1.403,00	Cat.E	1.763,00
Cat.4	1.449,00	Cat.F	2.038,00
Cat.5	1.484,00	Cat.G	2.164,00
Cat.6	1.519,00	Cat.H	2.347,00
Cat.7	1.566,00	Cat.I	2.702,00
Cat.8	1.612,00	Cat.L	2.862,00
Cat.9	1.752,00	Cat.M	3.068,00
Cat.10	1.845,00		
Cat.11	1.950,00		
Cat.12	2.054,00		
Cat.13	2.182,00		

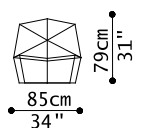

SESSEL

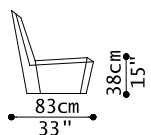

1GSPP

1GSPP		2GSPP	
Cat.3	1.270,00	Cat.E	1.594,00
Cat.4	1.309,00	Cat.F	1.825,00
Cat.5	1.339,00	Cat.G	1.931,00
Cat.6	1.368,00	Cat.H	2.085,00
Cat.7	1.408,00	Cat.I	2.384,00
Cat.8	1.447,00	Cat.L	2.519,00
Cat.9	1.565,00	Cat.M	2.692,00
Cat.10	1.643,00		
Cat.11	1.732,00		
Cat.12	1.820,00		
Cat.13	1.928,00		

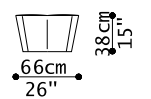

HOCKER

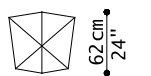

1GSPPPOUFF

1GSPPPOUFF		2GSPPPOUFF	
Cat.3	769,00	Cat.E	980,00
Cat.4	787,00	Cat.F	1.137,00
Cat.5	800,00	Cat.G	1.209,00
Cat.6	814,00	Cat.H	1.314,00
Cat.7	832,00	Cat.I	1.517,00
Cat.8	850,00	Cat.L	1.609,00
Cat.9	905,00	Cat.M	1.726,00
Cat.10	941,00		
Cat.11	982,00		
Cat.12	1.023,00		
Cat.13	1.073,00		

07 S74 N/E D. ORANGE 03.2023

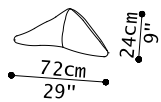

NIERENKISSEN

1GSPCP72

1GSPCP72		2GSPCP72	
Cat.3	133,00	Cat.E	169,00
Cat.4	140,00	Cat.F	213,00
Cat.5	145,00	Cat.G	233,00
Cat.6	151,00	Cat.H	262,00
Cat.7	158,00	Cat.I	318,00
Cat.8	165,00	Cat.L	343,00
Cat.9	187,00	Cat.M	376,00
Cat.10	202,00		
Cat.11	218,00		
Cat.12	234,00		
Cat.13	254,00		

SESSEL MIT VERSTELLBARER RÜCKENLEHNE, HÖHENVERSTELLBARE KOPFSTÜTZE. DREHMECHANISMUS MIT "RETURN MEMORY".



02HONC1

1 SESSEL RELAX NUSSBAUM-BASIS AUS
GLÄNZENDEM ALUMINIUM
1 HOCKER NUSSBAUM-BASIS AUS
GLÄNZENDEM ALUMINIUM

02HONC1

Cat.E	3.188,00
Cat.F	3.438,00
Cat.G	3.552,00
Cat.H	3.720,00
Cat.I	4.042,00
Cat.L	4.188,00
Cat.M	4.375,00



02HONC2

1 SESSEL RELAX NATURAL EICHE-BASIS
AUS GLÄNZENDEM ALUMINIUM
1 HOCKER NATURAL EICHE-BASIS AUS
GLÄNZENDEM ALUMINIUM

02HONC2

Cat.E	3.153,00
Cat.F	3.404,00
Cat.G	3.518,00
Cat.H	3.684,00
Cat.I	4.008,00
Cat.L	4.154,00
Cat.M	4.341,00



02HONC3

1 SESSEL RELAX NUSSBAUM-BASIS AUS
SCHWARZ LACKIERT
1 HOCKER NUSSBAUM-BASIS AUS
SCHWARZ LACKIERT

02HONC3

Cat.E	3.437,00
Cat.F	3.692,00
Cat.G	3.809,00
Cat.H	3.978,00
Cat.I	4.307,00
Cat.L	4.455,00
Cat.M	4.646,00

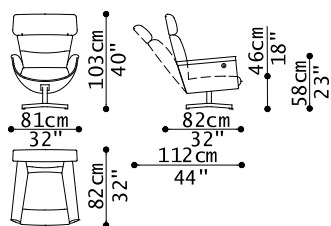

2HONPAGNO

SESSEL RELAX NUSSBAUM-BASIS AUS
GLÄNZENDEM ALUMINIUM

2HONPAGNO

Cat.E	2.475,00
Cat.F	2.684,00
Cat.G	2.779,00
Cat.H	2.919,00
Cat.I	3.188,00
Cat.L	3.310,00
Cat.M	3.466,00

07 S74 N/E D. ORANGE 03.2023

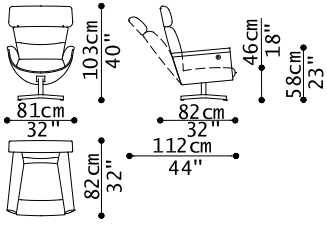

2HONPAGNONV

SESSEL RELAX NUSSBAUM-BASIS AUS SCHWARZ LACKIERT

2HONPAGNONV	
Cat.E	2.589,00
Cat.F	2.802,00
Cat.G	2.900,00
Cat.H	3.042,00
Cat.I	3.317,00
Cat.L	3.441,00
Cat.M	3.601,00

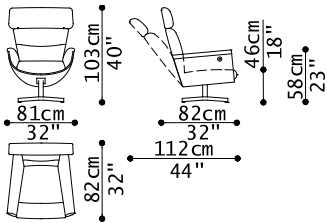

2HONPAGRN

SESSEL RELAX NATURAL EICHE-BASIS AUS GLÄNZENDEM ALUMINIUM

2HONPAGRN	
Cat.E	2.454,00
Cat.F	2.663,00
Cat.G	2.758,00
Cat.H	2.897,00
Cat.I	3.167,00
Cat.L	3.289,00
Cat.M	3.445,00

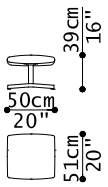

2HONPOUFFNO

HOCKER NUSSBAUM-BASIS AUS GLÄNZENDEM ALUMINIUM

2HONPOUFFNO	
Cat.E	713,00
Cat.F	754,00
Cat.G	773,00
Cat.H	801,00
Cat.I	854,00
Cat.L	878,00
Cat.M	909,00

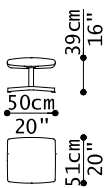

2HONPOUFFNONV

HOCKER NUSSBAUM-BASIS AUS SCHWARZ LACKIERT

2HONPOUFFNONV	
Cat.E	848,00
Cat.F	890,00
Cat.G	909,00
Cat.H	936,00
Cat.I	990,00
Cat.L	1.014,00
Cat.M	1.045,00

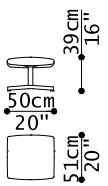

2HONPOUFFRN

HOCKER NATURAL EICHE-BASIS AUS GLÄNZENDEM ALUMINIUM

2HONPOUFFRN	
Cat.E	699,00
Cat.F	741,00
Cat.G	760,00
Cat.H	787,00
Cat.I	841,00
Cat.L	865,00
Cat.M	896,00

07 S74 N/E D. ORANGE 03.2023

TOP AUS MDF, CANALETTO NUSSBAUM ODER DUNKLE EICHE. FUSS AUS METAL- Auswahl: FRENCH BRONZE, GUN METAL, POLIERT BRÜNIERT.

	<p>1 TISCH LARGE STANDARD, H. 30 CM 1 TISCH MEDIUM STANDARD, H. 23 CM 1 TISCH SMALL STANDARD, H. 40 CM</p>	<p>01ISNC1 3.642,00</p>
<p>01ISNC1</p>		
	<p>TISCH LARGE STANDARD, H. 30 CM</p>	<p>1ISNTLTS30 1.436,00</p>
<p>1ISNTLTS30</p>		
	<p>TISCH LARGE, H. 40 CM</p>	<p>1ISNTLT40 1.459,00</p>
<p>1ISNTLT40</p>		
	<p>TISCH LARGE, H. 23 CM</p>	<p>1ISNTLT23 1.411,00</p>
<p>1ISNTLT23</p>		
	<p>TISCH MEDIUM STANDARD, H. 23 CM</p>	<p>1ISNTMTS23 1.195,00</p>
<p>1ISNTMTS23</p>		

07 S74 N/E D. ORANGE 03.2023

	<p>TISCH MEDIUM, H. 40 CM</p>	<p>1ISNTMT40 1.243,00</p>
	<p>TISCH MEDIUM, H. 30 CM</p>	<p>1ISNTMT30 1.220,00</p>
	<p>TISCH SMALL STANDARD, H. 40 CM</p>	<p>1ISNTSTS40 1.011,00</p>
	<p>TISCH SMALL, H. 30 CM</p>	<p>1ISNTST30 988,00</p>
	<p>TISCH SMALL, H. 23 CM</p>	<p>1ISNTST23 962,00</p>

LACKIERT BEARBEITUNG (TOP UND STRUKTUR). FARBEN ZUR AUSWAHL: BORDEAUX, GREEN, BLUE, GREY, IVORY, DOVE GREY, MINK BROWN, RUST, MIST, CREAM, DARK BROWN, BURGUNDY, SNOW, ASH GREY.

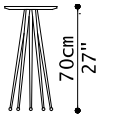
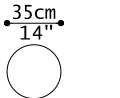
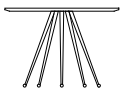
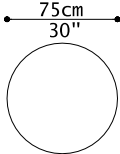
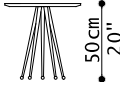
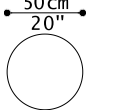
	<p>HOHER COUCHTISCH</p>	<table border="1"> <thead> <tr> <th colspan="2">1JAGTH</th> </tr> </thead> <tbody> <tr> <td>Z1</td> <td>804,00</td> </tr> </tbody> </table>	1JAGTH		Z1	804,00
1JAGTH						
Z1	804,00					
	<p>1JAGTH</p>					
	<p>MEDIUM COUCHTISCH</p>	<table border="1"> <thead> <tr> <th colspan="2">1JAGTM</th> </tr> </thead> <tbody> <tr> <td>Z1</td> <td>1.094,00</td> </tr> </tbody> </table>	1JAGTM		Z1	1.094,00
1JAGTM						
Z1	1.094,00					
	<p>1JAGTM</p>					
	<p>NIEDRIGER COUCHTISCH</p>	<table border="1"> <thead> <tr> <th colspan="2">1JAGTL</th> </tr> </thead> <tbody> <tr> <td>Z1</td> <td>877,00</td> </tr> </tbody> </table>	1JAGTL		Z1	877,00
1JAGTL						
Z1	877,00					
	<p>1JAGTL</p>					

BEZÜGE SIND NICHT ABNEHMBAR. DAS MODELL KANN MIT VERSCHIEDENEN STOFFEN FÜR BASIS - AUSSEN RÜCKSEITE UND SITZ - INNEN RÜCKSEITE ÜBERZOGEN WERDEN. STOFFE MIT MUSTERN EIGNEN SICH NICHT FÜR DIESES MODELL. LIEFERBAR AUCH AUS KUNSTLEDER (NICHT ABNEHMBAR). METALL FUSS, H. 7 CM - AUSWAHL: FRENCH BRONZE, GUN METAL, POLIERT BRÜNIERT.

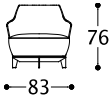
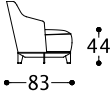
		SESSEL 1JAMP	1JAMP		2JAMP	
			Cat.3	2.378,00	Cat.E	2.588,00
			Cat.4	2.428,00	Cat.F	2.841,00
			Cat.5	2.466,00	Cat.G	2.957,00
			Cat.6	2.504,00	Cat.H	3.125,00
			Cat.7	2.554,00	Cat.I	3.452,00
			Cat.8	2.604,00	Cat.L	3.600,00
			Cat.9	2.754,00	Cat.M	3.789,00
			Cat.10	2.855,00		
			Cat.11	2.968,00		
			Cat.12	3.080,00		
			Cat.13	3.218,00		

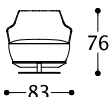
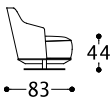
		DREHSESSEL 1JAMPG	1JAMPG		2JAMPG	
			Cat.3	2.572,00	Cat.E	2.782,00
			Cat.4	2.623,00	Cat.F	3.035,00
			Cat.5	2.660,00	Cat.G	3.151,00
			Cat.6	2.698,00	Cat.H	3.320,00
			Cat.7	2.748,00	Cat.I	3.646,00
			Cat.8	2.798,00	Cat.L	3.794,00
			Cat.9	2.949,00	Cat.M	3.984,00
			Cat.10	3.049,00		
			Cat.11	3.162,00		
			Cat.12	3.275,00		
			Cat.13	3.413,00		

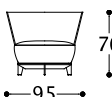
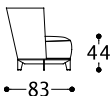
		LARGE SESSEL 1JAMPL	1JAMPL		2JAMPL	
			Cat.3	2.487,00	Cat.E	2.687,00
			Cat.4	2.545,00	Cat.F	2.949,00
			Cat.5	2.588,00	Cat.G	3.069,00
			Cat.6	2.631,00	Cat.H	3.243,00
			Cat.7	2.688,00	Cat.I	3.581,00
			Cat.8	2.746,00	Cat.L	3.734,00
			Cat.9	2.918,00	Cat.M	3.930,00
			Cat.10	3.033,00		
			Cat.11	3.162,00		
			Cat.12	3.291,00		
			Cat.13	3.449,00		

07 S74 N/E D. ORANGE 03.2023

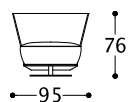

LARGE DREHSESSEL

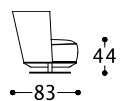

1JAMPLG

1JAMPLG		2JAMPLG	
Cat.3	2.686,00	Cat.E	2.881,00
Cat.4	2.746,00	Cat.F	3.143,00
Cat.5	2.790,00	Cat.G	3.263,00
Cat.6	2.835,00	Cat.H	3.438,00
Cat.7	2.895,00	Cat.I	3.776,00
Cat.8	2.954,00	Cat.L	3.928,00
Cat.9	3.133,00	Cat.M	4.125,00
Cat.10	3.252,00		
Cat.11	3.387,00		
Cat.12	3.521,00		
Cat.13	3.685,00		

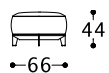

1JAMPOUFF

HOCKER

1JAMPOUFF		2JAMPOUFF	
Cat.3	1.442,00	Cat.E	1.584,00
Cat.4	1.470,00	Cat.F	1.741,00
Cat.5	1.491,00	Cat.G	1.813,00
Cat.6	1.511,00	Cat.H	1.918,00
Cat.7	1.539,00	Cat.I	2.121,00
Cat.8	1.567,00	Cat.L	2.213,00
Cat.9	1.650,00	Cat.M	2.330,00
Cat.10	1.705,00		
Cat.11	1.767,00		
Cat.12	1.829,00		
Cat.13	1.905,00		

LACKIERT BEARBEITUNG. FARBEN ZUR AUSWAHL: BORDEAUX, GREEN, BLUE, GREY, IVORY, DOVE GREY, MINK BROWN, RUST, MIST, CREAM, DARK BROWN, BURGUNDY, SNOW, ASH GREY. BASIS AUS METALL-Auswahl: FRENCH BRONZE, GUN METAL, POLIERT BRÜNIERT.

	<p>RECHTECKIGER TISCH 150X90 H.54 (HOCH)</p>	<table border="1"> <thead> <tr> <th colspan="2">1JI3TAVRH</th> </tr> </thead> <tbody> <tr> <td>Z1</td> <td>1.891,00</td> </tr> </tbody> </table>	1JI3TAVRH		Z1	1.891,00
1JI3TAVRH						
Z1	1.891,00					
<p>1JI3TAVRH</p>						
	<p>RECHTECKIGER TISCH 150X90 H.40 (MEDIUM)</p>	<table border="1"> <thead> <tr> <th colspan="2">1JI3TAVRM</th> </tr> </thead> <tbody> <tr> <td>Z1</td> <td>1.828,00</td> </tr> </tbody> </table>	1JI3TAVRM		Z1	1.828,00
1JI3TAVRM						
Z1	1.828,00					
<p>1JI3TAVRM</p>						
	<p>RECHTECKIGER TISCH 150X90 H.30 (NIEDRIG)</p>	<table border="1"> <thead> <tr> <th colspan="2">1JI3TAVRL</th> </tr> </thead> <tbody> <tr> <td>Z1</td> <td>1.798,00</td> </tr> </tbody> </table>	1JI3TAVRL		Z1	1.798,00
1JI3TAVRL						
Z1	1.798,00					
<p>1JI3TAVRL</p>						
	<p>QUADRATISCHER TISCH 120X120 H. 54 (HOCH)</p>	<table border="1"> <thead> <tr> <th colspan="2">1JI3TAVQ120H</th> </tr> </thead> <tbody> <tr> <td>Z1</td> <td>1.963,00</td> </tr> </tbody> </table>	1JI3TAVQ120H		Z1	1.963,00
1JI3TAVQ120H						
Z1	1.963,00					
<p>1JI3TAVQ120H</p>						
	<p>QUADRATISCHER TISCH 120X120 H.40 (MEDIUM)</p>	<table border="1"> <thead> <tr> <th colspan="2">1JI3TAVQ120M</th> </tr> </thead> <tbody> <tr> <td>Z1</td> <td>1.900,00</td> </tr> </tbody> </table>	1JI3TAVQ120M		Z1	1.900,00
1JI3TAVQ120M						
Z1	1.900,00					
<p>1JI3TAVQ120M</p>						
	<p>QUADRATISCHER TISCH 120X120 H.30 (NIEDRIG)</p>	<table border="1"> <thead> <tr> <th colspan="2">1JI3TAVQ120L</th> </tr> </thead> <tbody> <tr> <td>Z1</td> <td>1.869,00</td> </tr> </tbody> </table>	1JI3TAVQ120L		Z1	1.869,00
1JI3TAVQ120L						
Z1	1.869,00					
<p>1JI3TAVQ120L</p>						
	<p>QUADRATISCHER TISCH 75X75 H.54 (HOCH)</p>	<table border="1"> <thead> <tr> <th colspan="2">1JI3TAVQ75H</th> </tr> </thead> <tbody> <tr> <td>Z1</td> <td>1.052,00</td> </tr> </tbody> </table>	1JI3TAVQ75H		Z1	1.052,00
1JI3TAVQ75H						
Z1	1.052,00					
<p>1JI3TAVQ75H</p>						

07 S74 N/E D. ORANGE 03.2023

	<p>QUADRATISCHER TISCH 75X75 H.40 (MEDIUM)</p>	<table border="1"> <tr> <th colspan="2">1JI3TAVQ75M</th> </tr> <tr> <td>Z1</td> <td>989,00</td> </tr> </table>	1JI3TAVQ75M		Z1	989,00
1JI3TAVQ75M						
Z1	989,00					
	<p>QUADRATISCHER TISCH 75X75 H.30 (NIEDRIG)</p>	<table border="1"> <tr> <th colspan="2">1JI3TAVQ75L</th> </tr> <tr> <td>Z1</td> <td>958,00</td> </tr> </table>	1JI3TAVQ75L		Z1	958,00
1JI3TAVQ75L						
Z1	958,00					
	<p>QUADRATISCHER TISCH 55X55 H.54 (HOCH)</p>	<table border="1"> <tr> <th colspan="2">1JI3TAVQ55H</th> </tr> <tr> <td>Z1</td> <td>913,00</td> </tr> </table>	1JI3TAVQ55H		Z1	913,00
1JI3TAVQ55H						
Z1	913,00					
	<p>QUADRATISCHER TISCH 55X55 H.40 (MEDIUM)</p>	<table border="1"> <tr> <th colspan="2">1JI3TAVQ55M</th> </tr> <tr> <td>Z1</td> <td>850,00</td> </tr> </table>	1JI3TAVQ55M		Z1	850,00
1JI3TAVQ55M						
Z1	850,00					
	<p>QUADRATISCHER TISCH 55X55 H.30 (NIEDRIG)</p>	<table border="1"> <tr> <th colspan="2">1JI3TAVQ55L</th> </tr> <tr> <td>Z1</td> <td>820,00</td> </tr> </table>	1JI3TAVQ55L		Z1	820,00
1JI3TAVQ55L						
Z1	820,00					
	<p>KONSOLE 160X40 H.54</p>	<table border="1"> <tr> <th colspan="2">1JI3CO160</th> </tr> <tr> <td>Z1</td> <td>1.217,00</td> </tr> </table>	1JI3CO160		Z1	1.217,00
1JI3CO160						
Z1	1.217,00					
	<p>KONSOLE 90X40 H.54</p>	<table border="1"> <tr> <th colspan="2">1JI3CO90</th> </tr> <tr> <td>Z1</td> <td>936,00</td> </tr> </table>	1JI3CO90		Z1	936,00
1JI3CO90						
Z1	936,00					
	<p>SEITENTISCH</p>	<table border="1"> <tr> <th colspan="2">1JI3SER</th> </tr> <tr> <td>Z1</td> <td>1.260,00</td> </tr> </table>	1JI3SER		Z1	1.260,00
1JI3SER						
Z1	1.260,00					

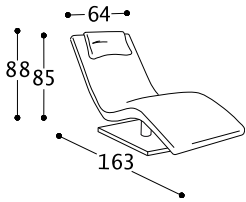

07 S74 N/E D. ORANGE 03.2023

DIE STOFF-VERSION IST ABNEHMBAR. DIESES MODELL KANN NUR MIT EINEM EINZELNEN STOFF BEZOGEN WERDEN. GESTREIFTE STOFFE ODER STOFFE MIT MUSTERN EIGNEN SICH NICHT FÜR DIESES MODELL. LIEFERBAR AUCH AUS KUNSTLEDER (NICHT ABNEHMBAR). BASIS AUS METALL, H. 17 CM.

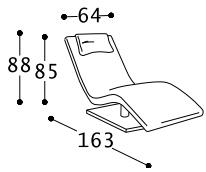

C1KLT

1 DREH-LIEGE MIT BASIS AUS
VERCHROMTEM METALL
1 KOPFLEHNE

C1KLT		C1PKLD	
Cat.3	1.646,00	Cat.E	1.882,00
Cat.4	1.694,00	Cat.F	2.098,00
Cat.5	1.729,00	Cat.G	2.198,00
Cat.6	1.765,00	Cat.H	2.343,00
Cat.7	1.812,00	Cat.I	2.624,00
Cat.8	1.861,00	Cat.L	2.751,00
Cat.9	2.003,00	Cat.M	2.913,00
Cat.10	2.098,00		
Cat.11	2.206,00		
Cat.12	2.312,00		
Cat.13	2.443,00		

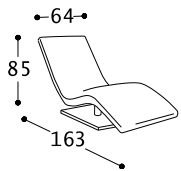

CHLGKLT

DREH-LIEGE MIT BASIS
AUS VERCHROMTEM METALL

CHLGKLT		CHLGPKLD	
Cat.3	1.494,00	Cat.E	1.725,00
Cat.4	1.533,00	Cat.F	1.916,00
Cat.5	1.562,00	Cat.G	2.004,00
Cat.6	1.591,00	Cat.H	2.132,00
Cat.7	1.630,00	Cat.I	2.380,00
Cat.8	1.670,00	Cat.L	2.492,00
Cat.9	1.787,00	Cat.M	2.635,00
Cat.10	1.865,00		
Cat.11	1.953,00		
Cat.12	2.040,00		
Cat.13	2.148,00		

07 S74 N/E D. ORANGE 03.2023

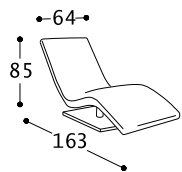

1KLDCHLGNV

DREH-LIEGE MIT BASIS AUS
MATTSCHWARZ LACKIERT

1KLDCHLGNV		2KLPCHLGNV	
Cat.3	1.494,00	Cat.E	1.725,00
Cat.4	1.533,00	Cat.F	1.916,00
Cat.5	1.562,00	Cat.G	2.004,00
Cat.6	1.591,00	Cat.H	2.132,00
Cat.7	1.630,00	Cat.I	2.380,00
Cat.8	1.670,00	Cat.L	2.492,00
Cat.9	1.787,00	Cat.M	2.635,00
Cat.10	1.865,00		
Cat.11	1.953,00		
Cat.12	2.040,00		
Cat.13	2.148,00		

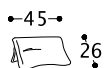

PTKLT

KOPFLEHNE

PTKLT		PTPKLD	
Cat.3	152,00	Cat.E	157,00
Cat.4	161,00	Cat.F	182,00
Cat.5	167,00	Cat.G	194,00
Cat.6	174,00	Cat.H	211,00
Cat.7	182,00	Cat.I	244,00
Cat.8	191,00	Cat.L	259,00
Cat.9	216,00	Cat.M	278,00
Cat.10	233,00		
Cat.11	253,00		
Cat.12	272,00		
Cat.13	295,00		

MANHATTAN 2

Währung: EUR

alberta
Made in Italy

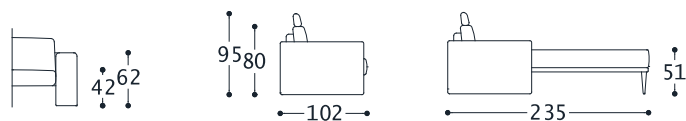

07 S74 N/E D. ORANGE 03.2023

DIE STOFF-VERSION IST ABNEHMBAR UND MAN KANN SITZKISSEN, CHASSIS UND RÜCKENKISSEN MIT UNTERSCHIEDLICHEN STOFFEN BEZIEHEN. GESTREIFTE STOFFE ODER STOFFE MIT MUSTERN EIGNEN SICH NUR FÜR RÜCKENKISSEN. LIEFERBAR AUCH AUS KUNSTLEDER (NICHT ABNEHMBAR). STANDARD RÜCKENKISSEN AUS DAUNENGEMISCH. AUF WUNSCH KANN MAN AUCH MIT RÜCKENKISSEN AUS POLYURETANSCHAUM GELIEFERT. ES IST ERFORDERLICH, AM ENDE DES ARTIKELCODES EINE "G" EINZUFÜGEN ZB.: 1MN2D3G/2MN2D3G. DIE ELEMENTE WERDEN MIT ABS FUSS H. 4 CM (Kod. 650) STANDARD GELIEFERT. AUF WUNSCH KANN MAN AUCH MIT FÜSSE AUS METALL VERCHROMT, H. 4 CM - (Kod. 158), DIE EINEN AUFSCHLAG VON 210,00 EURO PRO STÜCK AUF DER PREISLISTE HAT. WENN NICHT ANGEZEIGT, WERDEN STANDARD FÜSSE KODE 650 GELIEFERT. DIE SCHLAFSOFAS SIND MIT POLYURETHANSCHAUMMATRATZE H. 11 CM UND MIT SPEZIELLEM LATTENROST GELIEFERT: DARAN WERDEN DIE SITZKISSEN BEFESTIGT.

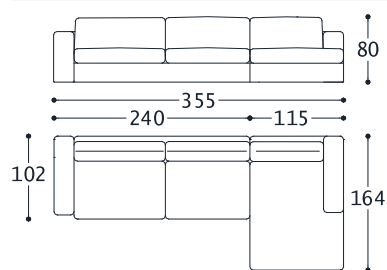

01MN2C4

1 DORMEUSE ARMLEHNE RECHTS
1 DREI SITZER MAXI SOFA ARMLEHNE LINKS

01MN2C4		02MN2C4	
Cat.3	3.633,00	Cat.E	5.119,00
Cat.4	3.894,00	Cat.F	6.375,00
Cat.5	4.090,00	Cat.G	6.952,00
Cat.6	4.287,00	Cat.H	7.790,00
Cat.7	4.547,00	Cat.I	9.413,00
Cat.8	4.808,00	Cat.L	10.147,00
Cat.9	5.592,00	Cat.M	11.090,00
Cat.10	6.115,00		
Cat.11	6.702,00		
Cat.12	7.291,00		
Cat.13	8.009,00		

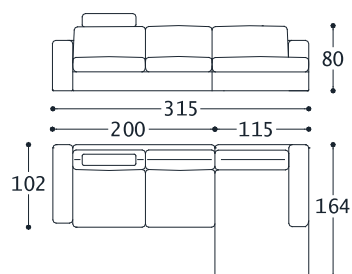

01MN2C1

1 DORMEUSE ARMLEHNE RECHTS
1 ZWEI SITZER MAXI SOFA ARMLEHNE LINKS
1 KOPFLEHNE 74 CM (GEEIGNET FÜR ZWEI SITZER MAXI SOFA UND DORMEUSE)

01MN2C1		02MN2C1	
Cat.3	3.370,00	Cat.E	4.760,00
Cat.4	3.636,00	Cat.F	5.946,00
Cat.5	3.837,00	Cat.G	6.490,00
Cat.6	4.037,00	Cat.H	7.282,00
Cat.7	4.304,00	Cat.I	8.814,00
Cat.8	4.571,00	Cat.L	9.508,00
Cat.9	5.371,00	Cat.M	10.398,00
Cat.10	5.906,00		
Cat.11	6.507,00		
Cat.12	7.108,00		
Cat.13	7.842,00		

MANHATTAN 2

Währung: EUR

alberta
Made in Italy

07 S74 N/E D. ORANGE 03.2023

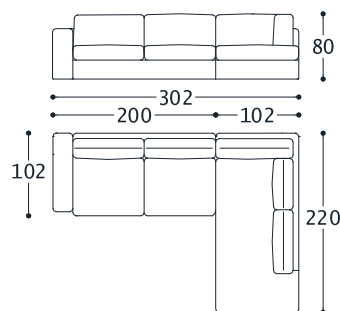

01MN2C7

1 ZWEI SITZER MAXI SOFA ARMLEHNE
LINKS
1 MERIDIENNE RECHTS

01MN2C7		02MN2C7	
Cat.3	3.763,00	Cat.E	5.299,00
Cat.4	4.091,00	Cat.F	6.619,00
Cat.5	4.338,00	Cat.G	7.224,00
Cat.6	4.584,00	Cat.H	8.104,00
Cat.7	4.913,00	Cat.I	9.810,00
Cat.8	5.241,00	Cat.L	10.581,00
Cat.9	6.226,00	Cat.M	11.571,00
Cat.10	6.883,00		
Cat.11	7.622,00		
Cat.12	8.361,00		
Cat.13	9.264,00		

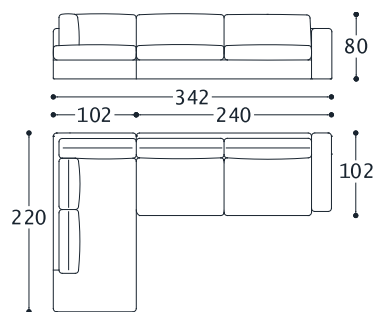

01MN2C9

1 DREI SITZER MAXI SOFA ARMLEHNE
RECHTS
1 MERIDIENNE LINKS

01MN2C9		02MN2C9	
Cat.3	4.163,00	Cat.E	5.844,00
Cat.4	4.497,00	Cat.F	7.278,00
Cat.5	4.748,00	Cat.G	7.936,00
Cat.6	5.000,00	Cat.H	8.891,00
Cat.7	5.334,00	Cat.I	10.744,00
Cat.8	5.668,00	Cat.L	11.581,00
Cat.9	6.672,00	Cat.M	12.657,00
Cat.10	7.341,00		
Cat.11	8.093,00		
Cat.12	8.846,00		
Cat.13	9.766,00		

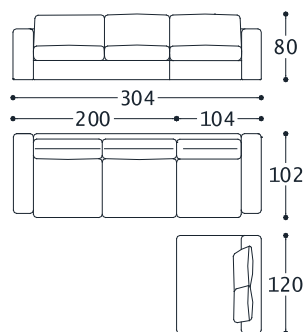

01MN2C2

1 ZWEI SITZER MAXI SOFA ARMLEHNE
LINKS
1 ZENTRAL JOLLY ELEMENT (2 "JOLLY"
RÜCKENKISSEN INKLUSIVE)
1 SESSEL ARMLEHNE RECHTS

01MN2C2		02MN2C2	
Cat.3	3.978,00	Cat.E	5.733,00
Cat.4	4.295,00	Cat.F	7.190,00
Cat.5	4.533,00	Cat.G	7.858,00
Cat.6	4.769,00	Cat.H	8.830,00
Cat.7	5.086,00	Cat.I	10.713,00
Cat.8	5.403,00	Cat.L	11.563,00
Cat.9	6.352,00	Cat.M	12.657,00
Cat.10	6.985,00		
Cat.11	7.698,00		
Cat.12	8.410,00		
Cat.13	9.280,00		

MANHATTAN 2

Währung: EUR

alberta
Made in Italy

07 S74 N/E D. ORANGE 03.2023

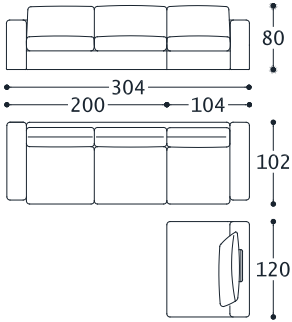

01MN2C6

1 ZWEI SITZER MAXI SOFA ARMLEHNE LINKS
1 ZENTRAL JOLLY ELEMENT 2 (1 "SPECIAL" RÜCKENKISSEN "INKLUSIVE")
1 SESSEL ARMLEHNE RECHTS

01MN2C6		02MN2C6	
Cat.3	4.148,00	Cat.E	5.876,00
Cat.4	4.468,00	Cat.F	7.322,00
Cat.5	4.707,00	Cat.G	7.984,00
Cat.6	4.946,00	Cat.H	8.948,00
Cat.7	5.265,00	Cat.I	10.817,00
Cat.8	5.583,00	Cat.L	11.661,00
Cat.9	6.539,00	Cat.M	12.745,00
Cat.10	7.177,00		
Cat.11	7.894,00		
Cat.12	8.612,00		
Cat.13	9.488,00		

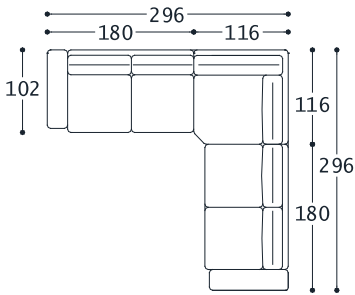

01MN2C5

1 ECKELEMENT
1 ZWEI SITZER SOFA ARMLEHNE RECHTS
1 ZWEI SITZER SOFA ARMLEHNE LINKS

01MN2C5		02MN2C5	
Cat.3	4.572,00	Cat.E	6.556,00
Cat.4	4.971,00	Cat.F	8.159,00
Cat.5	5.270,00	Cat.G	8.893,00
Cat.6	5.570,00	Cat.H	9.962,00
Cat.7	5.968,00	Cat.I	12.032,00
Cat.8	6.368,00	Cat.L	12.969,00
Cat.9	7.564,00	Cat.M	14.170,00
Cat.10	8.360,00		
Cat.11	9.259,00		
Cat.12	10.156,00		
Cat.13	11.254,00		

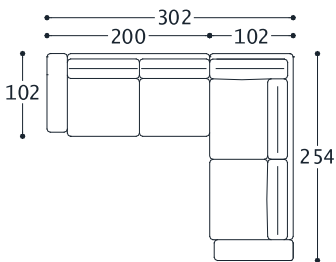

01MN2C3

1 DREI SITZER ECKELEMENT ARMLEHNE RECHTS
1 ZWEI SITZER MAXI SOFA ARMLEHNE LINKS

01MN2C3		02MN2C3	
Cat.3	3.954,00	Cat.E	5.687,00
Cat.4	4.284,00	Cat.F	7.158,00
Cat.5	4.532,00	Cat.G	7.833,00
Cat.6	4.780,00	Cat.H	8.814,00
Cat.7	5.111,00	Cat.I	10.715,00
Cat.8	5.441,00	Cat.L	11.574,00
Cat.9	6.433,00	Cat.M	12.677,00
Cat.10	7.094,00		
Cat.11	7.838,00		
Cat.12	8.583,00		
Cat.13	9.492,00		

MANHATTAN 2

Währung: EUR

alberta
Made in Italy

07 S74 N/E D. ORANGE 03.2023

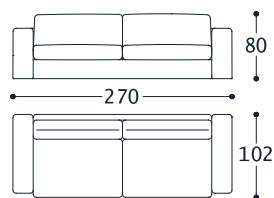

1MN2D3M

DREI SITZER MAXI SOFA

1MN2D3M		2MN2D3M	
Cat.3	2.277,00	Cat.E	3.175,00
Cat.4	2.446,00	Cat.F	3.968,00
Cat.5	2.573,00	Cat.G	4.331,00
Cat.6	2.700,00	Cat.H	4.860,00
Cat.7	2.870,00	Cat.I	5.884,00
Cat.8	3.039,00	Cat.L	6.346,00
Cat.9	3.548,00	Cat.M	6.941,00
Cat.10	3.887,00		
Cat.11	4.268,00		
Cat.12	4.649,00		
Cat.13	5.115,00		

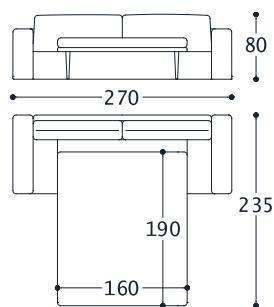

1MN2D3MSPP

DREI SITZER MAXI SOFA MIT "SPECIAL" ELEKTROGESCHWEISSTEM METALLROST UND POLYURETHANMATRATZE

1MN2D3MSPP		2MN2D3MSPP	
Cat.3	3.284,00	Cat.E	4.071,00
Cat.4	3.456,00	Cat.F	4.863,00
Cat.5	3.586,00	Cat.G	5.227,00
Cat.6	3.716,00	Cat.H	5.755,00
Cat.7	3.888,00	Cat.I	6.779,00
Cat.8	4.061,00	Cat.L	7.242,00
Cat.9	4.579,00	Cat.M	7.836,00
Cat.10	4.925,00		
Cat.11	5.313,00		
Cat.12	5.702,00		
Cat.13	6.177,00		

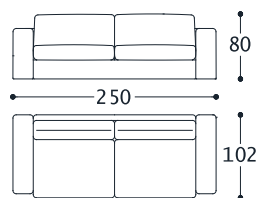

1MN2D3

DREI SITZER SOFA

1MN2D3		2MN2D3	
Cat.3	2.055,00	Cat.E	2.905,00
Cat.4	2.213,00	Cat.F	3.641,00
Cat.5	2.331,00	Cat.G	3.978,00
Cat.6	2.449,00	Cat.H	4.469,00
Cat.7	2.607,00	Cat.I	5.419,00
Cat.8	2.765,00	Cat.L	5.849,00
Cat.9	3.238,00	Cat.M	6.400,00
Cat.10	3.553,00		
Cat.11	3.907,00		
Cat.12	4.262,00		
Cat.13	4.696,00		

MANHATTAN 2

Währung: EUR

alberta
Made in Italy

07 S74 N/E D. ORANGE 03.2023

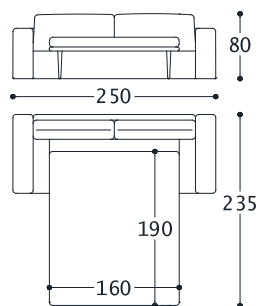

1MN2D3SPP

DREI SITZER SOFA MIT "SPECIAL"
ELEKTROGESCHWEISSTEM METALLROST
UND POLYURETHANMATRATZE

1MN2D3SPP		2MN2D3SPP	
Cat.3	3.050,00	Cat.E	3.816,00
Cat.4	3.215,00	Cat.F	4.552,00
Cat.5	3.339,00	Cat.G	4.889,00
Cat.6	3.463,00	Cat.H	5.379,00
Cat.7	3.628,00	Cat.I	6.330,00
Cat.8	3.793,00	Cat.L	6.759,00
Cat.9	4.288,00	Cat.M	7.311,00
Cat.10	4.618,00		
Cat.11	4.989,00		
Cat.12	5.361,00		
Cat.13	5.814,00		

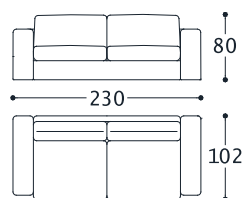

1MN2D2M

ZWEI SITZER MAXI SOFA

1MN2D2M		2MN2D2M	
Cat.3	1.868,00	Cat.E	2.631,00
Cat.4	2.026,00	Cat.F	3.314,00
Cat.5	2.144,00	Cat.G	3.627,00
Cat.6	2.262,00	Cat.H	4.082,00
Cat.7	2.420,00	Cat.I	4.965,00
Cat.8	2.577,00	Cat.L	5.364,00
Cat.9	3.050,00	Cat.M	5.876,00
Cat.10	3.366,00		
Cat.11	3.720,00		
Cat.12	4.075,00		
Cat.13	4.508,00		

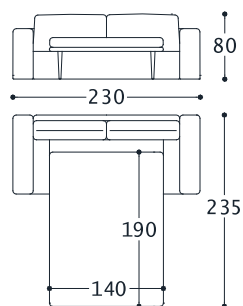

1MN2D2MSPP

ZWEI SITZER MAXI SOFA MIT "SPECIAL"
ELEKTROGESCHWEISSTEM METALLROST
UND POLYURETHANMATRATZE

1MN2D2MSPP		2MN2D2MSPP	
Cat.3	2.932,00	Cat.E	3.508,00
Cat.4	3.092,00	Cat.F	4.192,00
Cat.5	3.211,00	Cat.G	4.505,00
Cat.6	3.331,00	Cat.H	4.960,00
Cat.7	3.491,00	Cat.I	5.843,00
Cat.8	3.651,00	Cat.L	6.241,00
Cat.9	4.130,00	Cat.M	6.754,00
Cat.10	4.450,00		
Cat.11	4.810,00		
Cat.12	5.169,00		
Cat.13	5.609,00		

MANHATTAN 2

Währung: EUR

alberta
Made in Italy

07 S74 N/E D. ORANGE 03.2023

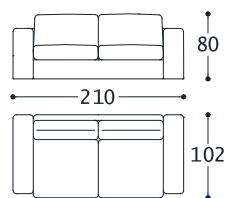

1MN2D2

ZWEI SITZER SOFA

1MN2D2		2MN2D2	
Cat.3	1.794,00	Cat.E	2.460,00
Cat.4	1.948,00	Cat.F	3.084,00
Cat.5	2.064,00	Cat.G	3.370,00
Cat.6	2.179,00	Cat.H	3.786,00
Cat.7	2.333,00	Cat.I	4.591,00
Cat.8	2.487,00	Cat.L	4.955,00
Cat.9	2.949,00	Cat.M	5.423,00
Cat.10	3.257,00		
Cat.11	3.603,00		
Cat.12	3.949,00		
Cat.13	4.373,00		

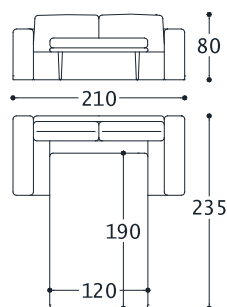

1MN2D2SPP

ZWEI SITZER SOFA MIT "SPECIAL"
ELEKTROGESCHWEISSTEM METALLROST
UND POLYURETHANMATRATZE

1MN2D2SPP		2MN2D2SPP	
Cat.3	2.698,00	Cat.E	3.330,00
Cat.4	2.847,00	Cat.F	3.954,00
Cat.5	2.958,00	Cat.G	4.239,00
Cat.6	3.070,00	Cat.H	4.655,00
Cat.7	3.219,00	Cat.I	5.461,00
Cat.8	3.367,00	Cat.L	5.825,00
Cat.9	3.814,00	Cat.M	6.293,00
Cat.10	4.111,00		
Cat.11	4.446,00		
Cat.12	4.780,00		
Cat.13	5.189,00		

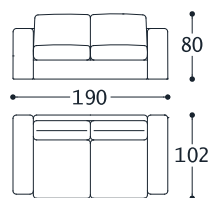

1MN2D2S

ZWEI SITZER SMALL SOFA

1MN2D2S		2MN2D2S	
Cat.3	1.697,00	Cat.E	2.317,00
Cat.4	1.847,00	Cat.F	2.891,00
Cat.5	1.959,00	Cat.G	3.154,00
Cat.6	2.071,00	Cat.H	3.536,00
Cat.7	2.220,00	Cat.I	4.278,00
Cat.8	2.370,00	Cat.L	4.612,00
Cat.9	2.818,00	Cat.M	5.043,00
Cat.10	3.117,00		
Cat.11	3.454,00		
Cat.12	3.790,00		
Cat.13	4.201,00		

07 S74 N/E D. ORANGE 03.2023

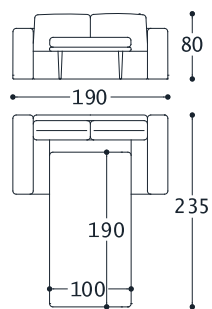

1MN2D2SSPP

ZWEI SITZER SMALL SOFA MIT "SPECIAL" ELEKTROGESCHWEISSTEM METALLROST UND POLYURETHANMATRATZE

1MN2D2SSPP		2MN2D2SSPP	
Cat.3	2.533,00	Cat.E	3.109,00
Cat.4	2.675,00	Cat.F	3.683,00
Cat.5	2.783,00	Cat.G	3.946,00
Cat.6	2.890,00	Cat.H	4.329,00
Cat.7	3.033,00	Cat.I	5.070,00
Cat.8	3.175,00	Cat.L	5.404,00
Cat.9	3.604,00	Cat.M	5.835,00
Cat.10	3.889,00		
Cat.11	4.211,00		
Cat.12	4.532,00		
Cat.13	4.925,00		

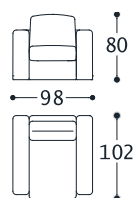

1MN2P

SESSEL

1MN2P		2MN2P	
Cat.3	1.121,00	Cat.E	1.530,00
Cat.4	1.221,00	Cat.F	1.898,00
Cat.5	1.295,00	Cat.G	2.066,00
Cat.6	1.369,00	Cat.H	2.312,00
Cat.7	1.469,00	Cat.I	2.787,00
Cat.8	1.568,00	Cat.L	3.002,00
Cat.9	1.865,00	Cat.M	3.277,00
Cat.10	2.063,00		
Cat.11	2.287,00		
Cat.12	2.510,00		
Cat.13	2.782,00		

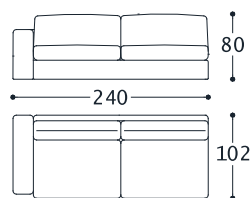

1MN2D3MSX

DREI SITZER MAXI SOFA ARMLEHNE LINKS
DREI SITZER MAXI SOFA ARMLEHNE
RECHTS

1MN2D3MSX		2MN2D3MSX	
1MN2D3MDX		2MN2D3MDX	
Cat.3	2.094,00	Cat.E	2.932,00
Cat.4	2.243,00	Cat.F	3.650,00
Cat.5	2.355,00	Cat.G	3.980,00
Cat.6	2.468,00	Cat.H	4.458,00
Cat.7	2.617,00	Cat.I	5.386,00
Cat.8	2.766,00	Cat.L	5.805,00
Cat.9	3.215,00	Cat.M	6.344,00
Cat.10	3.514,00		
Cat.11	3.850,00		
Cat.12	4.187,00		
Cat.13	4.598,00		

MANHATTAN 2

Wahrung: EUR

alberta
Made in Italy

07 S74 N/E D. ORANGE 03.2023

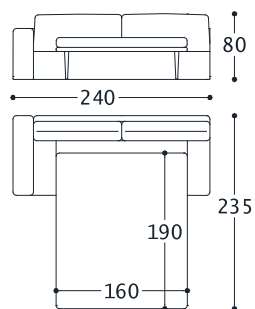

1MN2D3MSXSPP

DREI SITZER MAXI SOFA ARMLEHNE LINKS MIT "SPECIAL" ELEKTROGESCHWEISSTEM METALLROST UND POLYURETHANMATRATZE
DREI SITZER MAXI SOFA ARMLEHNE RECHTS MIT "SPECIAL" ELEKTROGESCHWEISSTEM METALLROST UND POLYURETHANMATRATZE

1MN2D3MSXSPP		2MN2D3MSXSPP	
1MN2D3MDXSPP		2MN2D3MDXSPP	
Cat.3	2.992,00	Cat.E	3.772,00
Cat.4	3.149,00	Cat.F	4.534,00
Cat.5	3.266,00	Cat.G	4.884,00
Cat.6	3.384,00	Cat.H	5.392,00
Cat.7	3.541,00	Cat.I	6.376,00
Cat.8	3.698,00	Cat.L	6.821,00
Cat.9	4.168,00	Cat.M	7.392,00
Cat.10	4.482,00		
Cat.11	4.835,00		
Cat.12	5.188,00		
Cat.13	5.620,00		

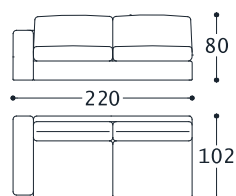

1MN2D3SX

DREI SITZER SOFA ARMLEHNE LINKS
DREI SITZER SOFA ARMLEHNE RECHTS

1MN2D3SX		2MN2D3SX	
1MN2D3DX		2MN2D3DX	
Cat.3	1.881,00	Cat.E	2.660,00
Cat.4	2.025,00	Cat.F	3.322,00
Cat.5	2.133,00	Cat.G	3.625,00
Cat.6	2.241,00	Cat.H	4.066,00
Cat.7	2.386,00	Cat.I	4.920,00
Cat.8	2.530,00	Cat.L	5.306,00
Cat.9	2.963,00	Cat.M	5.802,00
Cat.10	3.251,00		
Cat.11	3.576,00		
Cat.12	3.901,00		
Cat.13	4.298,00		

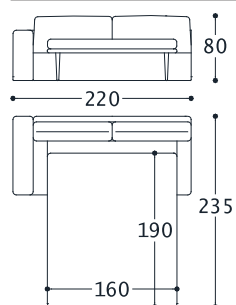

1MN2D3SXSPP

DREI SITZER SOFA ARMLEHNE LINKS MIT "SPECIAL" ELEKTROGESCHWEISSTEM METALLROST UND POLYURETHANMATRATZE
DREI SITZER SOFA ARMLEHNE RECHTS MIT "SPECIAL" ELEKTROGESCHWEISSTEM METALLROST UND POLYURETHANMATRATZE

1MN2D3SXSPP		2MN2D3SXSPP	
1MN2D3DXSPP		2MN2D3DXSPP	
Cat.3	2.878,00	Cat.E	3.579,00
Cat.4	3.028,00	Cat.F	4.240,00
Cat.5	3.141,00	Cat.G	4.543,00
Cat.6	3.253,00	Cat.H	4.984,00
Cat.7	3.403,00	Cat.I	5.838,00
Cat.8	3.554,00	Cat.L	6.224,00
Cat.9	4.004,00	Cat.M	6.720,00
Cat.10	4.305,00		
Cat.11	4.643,00		
Cat.12	4.981,00		
Cat.13	5.394,00		

MANHATTAN 2

Währung: EUR

alberta
Made in Italy

07 S74 N/E D. ORANGE 03.2023

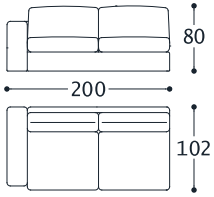

1MN2D2MSX

ZWEI SITZER MAXI SOFA ARMLEHNE LINKS
ZWEI SITZER MAXI SOFA ARMLEHNE
RECHTS

1MN2D2MSX		2MN2D2MSX	
1MN2D2MDX		2MN2D2MDX	
Cat.3	1.694,00	Cat.E	2.387,00
Cat.4	1.837,00	Cat.F	2.991,00
Cat.5	1.945,00	Cat.G	3.268,00
Cat.6	2.052,00	Cat.H	3.671,00
Cat.7	2.196,00	Cat.I	4.452,00
Cat.8	2.339,00	Cat.L	4.805,00
Cat.9	2.769,00	Cat.M	5.258,00
Cat.10	3.056,00		
Cat.11	3.379,00		
Cat.12	3.702,00		
Cat.13	4.096,00		

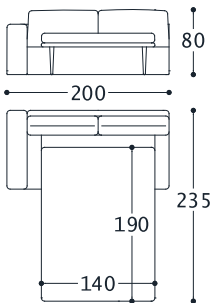

1MN2D2MSXSPP

ZWEI SITZER MAXI SOFA ARMLEHNE LINKS
MIT "SPECIAL" ELEKTROGESCHWEISSTEM
METALLROST UND
POLYURETHANMATRATZE
ZWEI SITZER MAXI SOFA ARMLEHNE
RECHTS MIT "SPECIAL"
ELEKTROGESCHWEISSTEM METALLROST
UND POLYURETHANMATRATZE

1MN2D2MSXSPP		2MN2D2MSXSPP	
1MN2D2MDXSPP		2MN2D2MDXSPP	
Cat.3	2.756,00	Cat.E	3.372,00
Cat.4	2.900,00	Cat.F	3.965,00
Cat.5	3.009,00	Cat.G	4.237,00
Cat.6	3.117,00	Cat.H	4.632,00
Cat.7	3.261,00	Cat.I	5.397,00
Cat.8	3.405,00	Cat.L	5.743,00
Cat.9	3.838,00	Cat.M	6.187,00
Cat.10	4.127,00		
Cat.11	4.452,00		
Cat.12	4.776,00		
Cat.13	5.173,00		

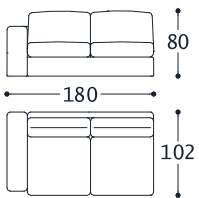

1MN2D2SX

ZWEI SITZER SOFA ARMLEHNE LINKS
ZWEI SITZER SOFA ARMLEHNE RECHTS

1MN2D2SX		2MN2D2SX	
1MN2D2DX		2MN2D2DX	
Cat.3	1.619,00	Cat.E	2.229,00
Cat.4	1.757,00	Cat.F	2.776,00
Cat.5	1.861,00	Cat.G	3.027,00
Cat.6	1.965,00	Cat.H	3.392,00
Cat.7	2.103,00	Cat.I	4.099,00
Cat.8	2.242,00	Cat.L	4.419,00
Cat.9	2.657,00	Cat.M	4.829,00
Cat.10	2.933,00		
Cat.11	3.245,00		
Cat.12	3.556,00		
Cat.13	3.937,00		

MANHATTAN 2

Wahrung: EUR

alberta
Made in Italy

07 S74 N/E D. ORANGE 03.2023

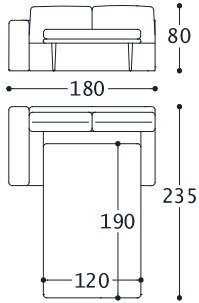

1MN2D2SXSP

ZWEI SITZER SOFA ARMLEHNE LINKS MIT "SPECIAL" ELEKTROGESCHWEISSTEM METALLROST UND POLYURETHANMATRATZE
ZWEI SITZER SOFA ARMLEHNE RECHTS MIT "SPECIAL" ELEKTROGESCHWEISSTEM METALLROST UND POLYURETHANMATRATZE

1MN2D2SXSP		2MN2D2SXSP	
1MN2D2DXSP		2MN2D2DXSP	
Cat.3	2.520,00	Cat.E	3.106,00
Cat.4	2.651,00	Cat.F	3.654,00
Cat.5	2.749,00	Cat.G	3.905,00
Cat.6	2.847,00	Cat.H	4.270,00
Cat.7	2.978,00	Cat.I	4.977,00
Cat.8	3.109,00	Cat.L	5.296,00
Cat.9	3.502,00	Cat.M	5.707,00
Cat.10	3.764,00		
Cat.11	4.059,00		
Cat.12	4.353,00		
Cat.13	4.713,00		

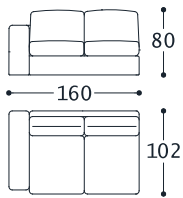

1MN2D2SSX

ZWEI SITZER SMALL SOFA ARMLEHNE LINKS
ZWEI SITZER SMALL SOFA ARMLEHNE RECHTS

1MN2D2SSX		2MN2D2SSX	
1MN2D2SDX		2MN2D2SDX	
Cat.3	1.484,00	Cat.E	2.074,00
Cat.4	1.603,00	Cat.F	2.565,00
Cat.5	1.693,00	Cat.G	2.790,00
Cat.6	1.782,00	Cat.H	3.117,00
Cat.7	1.901,00	Cat.I	3.751,00
Cat.8	2.020,00	Cat.L	4.037,00
Cat.9	2.378,00	Cat.M	4.405,00
Cat.10	2.616,00		
Cat.11	2.884,00		
Cat.12	3.152,00		
Cat.13	3.480,00		

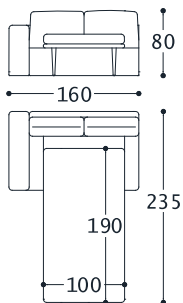

1MN2D2SSXSPP

ZWEI SITZER SMALL SOFA ARMLEHNE LINKS MIT "SPECIAL" ELEKTROGESCHWEISSTEM METALLROST UND POLYURETHANMATRATZE
ZWEI SITZER SMALL SOFA ARMLEHNE RECHTS MIT "SPECIAL" ELEKTROGESCHWEISSTEM METALLROST UND POLYURETHANMATRATZE

1MN2D2SSXSPP		2MN2D2SSXSPP	
1MN2D2SDXSPP		2MN2D2SDXSPP	
Cat.3	2.327,00	Cat.E	2.886,00
Cat.4	2.443,00	Cat.F	3.377,00
Cat.5	2.529,00	Cat.G	3.602,00
Cat.6	2.616,00	Cat.H	3.929,00
Cat.7	2.731,00	Cat.I	4.563,00
Cat.8	2.847,00	Cat.L	4.849,00
Cat.9	3.193,00	Cat.M	5.217,00
Cat.10	3.424,00		
Cat.11	3.684,00		
Cat.12	3.943,00		
Cat.13	4.261,00		

MANHATTAN 2

Währung: EUR

alberta
Made in Italy

07 S74 N/E D. ORANGE 03.2023

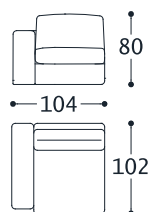

1MN2PSX

SESSEL ARMLEHNE LINKS
SESSEL ARMLEHNE RECHTS

1MN2PSX		2MN2PSX	
1MN2PDX		2MN2PDX	
Cat.3	1.021,00	Cat.E	1.412,00
Cat.4	1.110,00	Cat.F	1.745,00
Cat.5	1.176,00	Cat.G	1.897,00
Cat.6	1.242,00	Cat.H	2.119,00
Cat.7	1.330,00	Cat.I	2.549,00
Cat.8	1.418,00	Cat.L	2.743,00
Cat.9	1.682,00	Cat.M	2.993,00
Cat.10	1.858,00		
Cat.11	2.056,00		
Cat.12	2.254,00		
Cat.13	2.496,00		

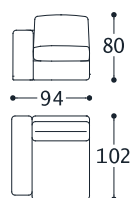

1MN2PSSX

SMALL SESSEL ARMLEHNE LINKS
SMALL SESSEL ARMLEHNE RECHTS

1MN2PSSX		2MN2PSSX	
1MN2PSDX		2MN2PSDX	
Cat.3	965,00	Cat.E	1.369,00
Cat.4	1.046,00	Cat.F	1.689,00
Cat.5	1.106,00	Cat.G	1.835,00
Cat.6	1.166,00	Cat.H	2.048,00
Cat.7	1.247,00	Cat.I	2.461,00
Cat.8	1.328,00	Cat.L	2.648,00
Cat.9	1.570,00	Cat.M	2.888,00
Cat.10	1.731,00		
Cat.11	1.913,00		
Cat.12	2.094,00		
Cat.13	2.316,00		

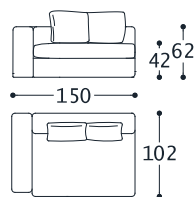

1MN2JSX

JOLLY ELEMENT ARMLEHNE LINKS (2
LOSSE JOLLY RÜCKENKISSEN INKLUSIV)
JOLLY ELEMENT ARMLEHNE RECHTS (2
LOSE JOLLY RÜCKENKISSEN INKLUSIV)

1MN2JSX		2MN2JSX	
1MN2JDX		2MN2JDX	
Cat.3	1.451,00	Cat.E	2.139,00
Cat.4	1.554,00	Cat.F	2.690,00
Cat.5	1.631,00	Cat.G	2.943,00
Cat.6	1.708,00	Cat.H	3.311,00
Cat.7	1.811,00	Cat.I	4.024,00
Cat.8	1.914,00	Cat.L	4.346,00
Cat.9	2.222,00	Cat.M	4.760,00
Cat.10	2.428,00		
Cat.11	2.660,00		
Cat.12	2.891,00		
Cat.13	3.174,00		

MANHATTAN 2

Währung: EUR

alberta
Made in Italy

07 S74 N/E D. ORANGE 03.2023

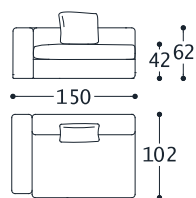

1MN2J2SX

JOLLY ELEMENT 2 ARMLEHNE LINKS (1 LOSER SPECIAL RÜCKENKISSEN INKLUSIV)
JOLLY ELEMENT 2 ARMLEHNE RECHTS (1 LOSER SPECIAL RÜCKENKISSEN INKLUSIV)

1MN2J2SX		2MN2J2SX	
1MN2J2DX		2MN2J2DX	
Cat.3	1.621,00	Cat.E	2.277,00
Cat.4	1.726,00	Cat.F	2.817,00
Cat.5	1.805,00	Cat.G	3.065,00
Cat.6	1.883,00	Cat.H	3.425,00
Cat.7	1.989,00	Cat.I	4.123,00
Cat.8	2.094,00	Cat.L	4.439,00
Cat.9	2.409,00	Cat.M	4.844,00
Cat.10	2.619,00		
Cat.11	2.855,00		
Cat.12	3.092,00		
Cat.13	3.381,00		

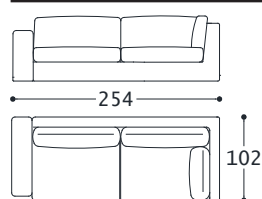

1MN2ANG3SX

DREI SITZER ECKELEMENT ARMLEHNE LINKS
DREI SITZER ECKELEMENT ARMLEHNE RECHTS

1MN2ANG3SX		2MN2ANG3SX	
1MN2ANG3DX		2MN2ANG3DX	
Cat.3	2.260,00	Cat.E	3.300,00
Cat.4	2.447,00	Cat.F	4.167,00
Cat.5	2.587,00	Cat.G	4.565,00
Cat.6	2.728,00	Cat.H	5.143,00
Cat.7	2.915,00	Cat.I	6.263,00
Cat.8	3.102,00	Cat.L	6.769,00
Cat.9	3.664,00	Cat.M	7.419,00
Cat.10	4.038,00		
Cat.11	4.459,00		
Cat.12	4.881,00		
Cat.13	5.396,00		

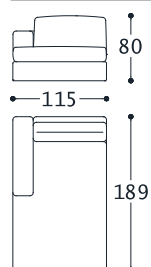

1MN2DORMXSX

MAXI DORMEUSE ARMLEHNE LINKS
MAXI DORMEUSE ARMLEHNE RECHTS

1MN2DORMXSX		2MN2DORMXSX	
1MN2DORMXDX		2MN2DORMXDX	
Cat.3	1.776,00	Cat.E	2.453,00
Cat.4	1.895,00	Cat.F	3.036,00
Cat.5	1.985,00	Cat.G	3.303,00
Cat.6	2.074,00	Cat.H	3.691,00
Cat.7	2.193,00	Cat.I	4.444,00
Cat.8	2.312,00	Cat.L	4.783,00
Cat.9	2.670,00	Cat.M	5.220,00
Cat.10	2.908,00		
Cat.11	3.176,00		
Cat.12	3.444,00		
Cat.13	3.772,00		

07 S74 N/E D. ORANGE 03.2023

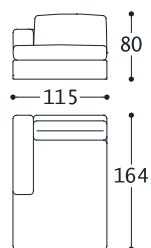

1MN2DORMSX

DORMEUSE ARMLEHNE LINKS
DORMEUSE ARMLEHNE RECHTS

1MN2DORMSX		2MN2DORMSX	
1MN2DORMDX		2MN2DORMDX	
Cat.3	1.539,00	Cat.E	2.187,00
Cat.4	1.651,00	Cat.F	2.725,00
Cat.5	1.735,00	Cat.G	2.972,00
Cat.6	1.819,00	Cat.H	3.332,00
Cat.7	1.930,00	Cat.I	4.027,00
Cat.8	2.042,00	Cat.L	4.342,00
Cat.9	2.377,00	Cat.M	4.746,00
Cat.10	2.601,00		
Cat.11	2.852,00		
Cat.12	3.104,00		
Cat.13	3.411,00		

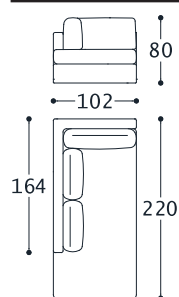

1MN2MERSX

MERIDIENNE LINKS
MERIDIENNE RECHTS

1MN2MERSX		2MN2MERSX	
1MN2MERDX		2MN2MERDX	
Cat.3	2.069,00	Cat.E	2.912,00
Cat.4	2.254,00	Cat.F	3.628,00
Cat.5	2.393,00	Cat.G	3.956,00
Cat.6	2.532,00	Cat.H	4.433,00
Cat.7	2.717,00	Cat.I	5.358,00
Cat.8	2.902,00	Cat.L	5.776,00
Cat.9	3.457,00	Cat.M	6.313,00
Cat.10	3.827,00		
Cat.11	4.243,00		
Cat.12	4.659,00		
Cat.13	5.168,00		

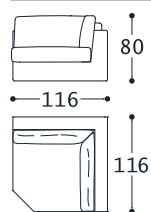

1MN2AR

ECKELEMENT

1MN2AR		2MN2AR	
Cat.3	1.334,00	Cat.E	2.098,00
Cat.4	1.457,00	Cat.F	2.607,00
Cat.5	1.548,00	Cat.G	2.839,00
Cat.6	1.640,00	Cat.H	3.178,00
Cat.7	1.762,00	Cat.I	3.834,00
Cat.8	1.884,00	Cat.L	4.131,00
Cat.9	2.250,00	Cat.M	4.512,00
Cat.10	2.494,00		
Cat.11	2.769,00		
Cat.12	3.044,00		
Cat.13	3.380,00		

07 S74 N/E D. ORANGE 03.2023

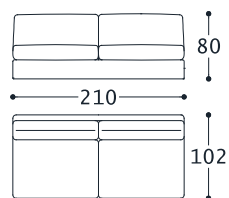

1MN2D3M1

ZENTRAL DREI SITZER MAXI SOFA

1MN2D3M1		2MN2D3M1	
Cat.3	1.912,00	Cat.E	2.639,00
Cat.4	2.043,00	Cat.F	3.283,00
Cat.5	2.142,00	Cat.G	3.578,00
Cat.6	2.240,00	Cat.H	4.008,00
Cat.7	2.371,00	Cat.I	4.839,00
Cat.8	2.502,00	Cat.L	5.215,00
Cat.9	2.895,00	Cat.M	5.698,00
Cat.10	3.157,00		
Cat.11	3.451,00		
Cat.12	3.746,00		
Cat.13	4.106,00		

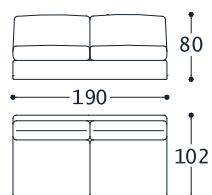

1MN2D31

ZENTRAL DREI SITZER SOFA

1MN2D31		2MN2D31	
Cat.3	1.713,00	Cat.E	2.359,00
Cat.4	1.844,00	Cat.F	2.946,00
Cat.5	1.942,00	Cat.G	3.215,00
Cat.6	2.041,00	Cat.H	3.606,00
Cat.7	2.172,00	Cat.I	4.365,00
Cat.8	2.303,00	Cat.L	4.707,00
Cat.9	2.696,00	Cat.M	5.147,00
Cat.10	2.958,00		
Cat.11	3.252,00		
Cat.12	3.547,00		
Cat.13	3.907,00		

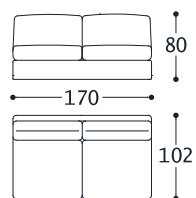

1MN2D2M1

ZENTRAL ZWEI SITZER MAXI SOFA

1MN2D2M1		2MN2D2M1	
Cat.3	1.642,00	Cat.E	2.109,00
Cat.4	1.773,00	Cat.F	2.639,00
Cat.5	1.872,00	Cat.G	2.882,00
Cat.6	1.970,00	Cat.H	3.236,00
Cat.7	2.101,00	Cat.I	3.920,00
Cat.8	2.232,00	Cat.L	4.229,00
Cat.9	2.625,00	Cat.M	4.627,00
Cat.10	2.887,00		
Cat.11	3.181,00		
Cat.12	3.476,00		
Cat.13	3.836,00		

07 S74 N/E D. ORANGE 03.2023

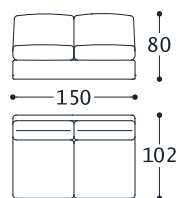

1MN2D21

ZENTRAL ZWEI SITZER SOFA

1MN2D21		2MN2D21	
Cat.3	1.444,00	Cat.E	1.957,00
Cat.4	1.567,00	Cat.F	2.430,00
Cat.5	1.659,00	Cat.G	2.647,00
Cat.6	1.751,00	Cat.H	2.962,00
Cat.7	1.874,00	Cat.I	3.573,00
Cat.8	1.997,00	Cat.L	3.849,00
Cat.9	2.365,00	Cat.M	4.204,00
Cat.10	2.611,00		
Cat.11	2.887,00		
Cat.12	3.164,00		
Cat.13	3.501,00		

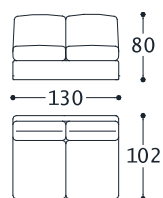

1MN2D2S1

ZENTRAL ZWEI SITZER SMALL SOFA

1MN2D2S1		2MN2D2S1	
Cat.3	1.312,00	Cat.E	1.814,00
Cat.4	1.417,00	Cat.F	2.230,00
Cat.5	1.496,00	Cat.G	2.421,00
Cat.6	1.575,00	Cat.H	2.698,00
Cat.7	1.680,00	Cat.I	3.236,00
Cat.8	1.785,00	Cat.L	3.478,00
Cat.9	2.100,00	Cat.M	3.790,00
Cat.10	2.310,00		
Cat.11	2.547,00		
Cat.12	2.783,00		
Cat.13	3.072,00		

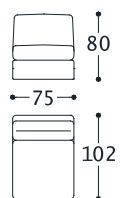

1MN2P1

ZENTRAL SESSEL

1MN2P1		2MN2P1	
Cat.3	859,00	Cat.E	1.263,00
Cat.4	933,00	Cat.F	1.583,00
Cat.5	988,00	Cat.G	1.730,00
Cat.6	1.044,00	Cat.H	1.943,00
Cat.7	1.118,00	Cat.I	2.356,00
Cat.8	1.192,00	Cat.L	2.542,00
Cat.9	1.414,00	Cat.M	2.782,00
Cat.10	1.562,00		
Cat.11	1.728,00		
Cat.12	1.895,00		
Cat.13	2.098,00		

07 S74 N/E D. ORANGE 03.2023

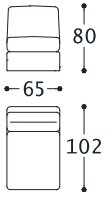

ZENTRAL SMALL SESSEL

1MN2PS1

1MN2PS1		2MN2PS1	
Cat.3	785,00	Cat.E	1.212,00
Cat.4	851,00	Cat.F	1.523,00
Cat.5	901,00	Cat.G	1.666,00
Cat.6	951,00	Cat.H	1.873,00
Cat.7	1.018,00	Cat.I	2.275,00
Cat.8	1.084,00	Cat.L	2.456,00
Cat.9	1.284,00	Cat.M	2.689,00
Cat.10	1.417,00		
Cat.11	1.567,00		
Cat.12	1.717,00		
Cat.13	1.900,00		

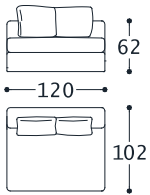

ZENTRAL JOLLY ELEMENT (2 "JOLLY" RÜCKENKISSEN INKLUSIVE)

1MN2J1

1MN2J1		2MN2J1	
Cat.3	1.263,00	Cat.E	1.934,00
Cat.4	1.348,00	Cat.F	2.454,00
Cat.5	1.412,00	Cat.G	2.693,00
Cat.6	1.475,00	Cat.H	3.040,00
Cat.7	1.560,00	Cat.I	3.712,00
Cat.8	1.646,00	Cat.L	4.015,00
Cat.9	1.901,00	Cat.M	4.406,00
Cat.10	2.071,00		
Cat.11	2.263,00		
Cat.12	2.454,00		
Cat.13	2.688,00		

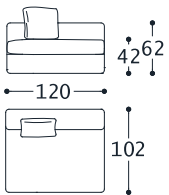

ZENTRAL JOLLY ELEMENT 2 (1 "SPECIAL" RÜCKENKISSEN "INKLUSIVE")

1MN2J21

1MN2J21		2MN2J21	
Cat.3	1.433,00	Cat.E	2.077,00
Cat.4	1.521,00	Cat.F	2.586,00
Cat.5	1.586,00	Cat.G	2.819,00
Cat.6	1.652,00	Cat.H	3.158,00
Cat.7	1.739,00	Cat.I	3.816,00
Cat.8	1.826,00	Cat.L	4.113,00
Cat.9	2.088,00	Cat.M	4.494,00
Cat.10	2.263,00		
Cat.11	2.459,00		
Cat.12	2.656,00		
Cat.13	2.896,00		

07 S74 N/E D. ORANGE 03.2023

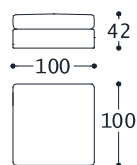

JOLLY HOCKER

1MN2PFFJ

1MN2PFFJ		2MN2PFFJ	
Cat.3	798,00	Cat.E	1.021,00
Cat.4	855,00	Cat.F	1.244,00
Cat.5	897,00	Cat.G	1.347,00
Cat.6	940,00	Cat.H	1.496,00
Cat.7	997,00	Cat.I	1.784,00
Cat.8	1.054,00	Cat.L	1.914,00
Cat.9	1.225,00	Cat.M	2.082,00
Cat.10	1.339,00		
Cat.11	1.467,00		
Cat.12	1.595,00		
Cat.13	1.752,00		

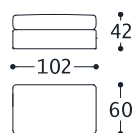

RECHTECKIGER HOCKER

1MN2PFFR

1MN2PFFR		2MN2PFFR	
Cat.3	670,00	Cat.E	968,00
Cat.4	711,00	Cat.F	1.192,00
Cat.5	741,00	Cat.G	1.294,00
Cat.6	772,00	Cat.H	1.443,00
Cat.7	812,00	Cat.I	1.731,00
Cat.8	853,00	Cat.L	1.862,00
Cat.9	975,00	Cat.M	2.029,00
Cat.10	1.057,00		
Cat.11	1.148,00		
Cat.12	1.240,00		
Cat.13	1.352,00		

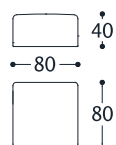

QUADRATISCHER HOCKER 80X80 CM

1MN2PF80

1MN2PF80		2MN2PF80	
Cat.3	479,00	Cat.E	676,00
Cat.4	511,00	Cat.F	808,00
Cat.5	535,00	Cat.G	868,00
Cat.6	559,00	Cat.H	955,00
Cat.7	590,00	Cat.I	1.125,00
Cat.8	622,00	Cat.L	1.202,00
Cat.9	718,00	Cat.M	1.300,00
Cat.10	781,00		
Cat.11	853,00		
Cat.12	925,00		
Cat.13	1.012,00		

07 S74 N/E D. ORANGE 03.2023

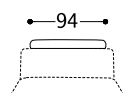

1MN2PTD3M

KOPFLEHNE 94 CM (GEEIGNET FÜR DREI SITZER MAXI SOFA)

1MN2PTD3M		2MN2PTD3M	
Cat.3	145,00	Cat.E	210,00
Cat.4	157,00	Cat.F	265,00
Cat.5	166,00	Cat.G	290,00
Cat.6	174,00	Cat.H	326,00
Cat.7	186,00	Cat.I	397,00
Cat.8	198,00	Cat.L	429,00
Cat.9	234,00	Cat.M	470,00
Cat.10	257,00		
Cat.11	284,00		
Cat.12	311,00		
Cat.13	343,00		

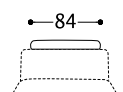

1MN2PTD3

KOPFLEHNE 84 CM (GEEIGNET FÜR DREI SITZER SOFA UND DREISITZER ECKELEMENT)

1MN2PTD3		2MN2PTD3	
Cat.3	142,00	Cat.E	205,00
Cat.4	153,00	Cat.F	260,00
Cat.5	162,00	Cat.G	285,00
Cat.6	171,00	Cat.H	322,00
Cat.7	183,00	Cat.I	392,00
Cat.8	195,00	Cat.L	424,00
Cat.9	230,00	Cat.M	465,00
Cat.10	254,00		
Cat.11	281,00		
Cat.12	307,00		
Cat.13	340,00		

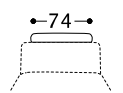

1MN2PTD2M

KOPFLEHNE 74 CM (GEEIGNET FÜR ZWEI SITZER MAXI SOFA UND DORMEUSE)

1MN2PTD2M		2MN2PTD2M	
Cat.3	137,00	Cat.E	186,00
Cat.4	148,00	Cat.F	230,00
Cat.5	157,00	Cat.G	250,00
Cat.6	166,00	Cat.H	279,00
Cat.7	178,00	Cat.I	335,00
Cat.8	190,00	Cat.L	361,00
Cat.9	225,00	Cat.M	394,00
Cat.10	249,00		
Cat.11	276,00		
Cat.12	302,00		
Cat.13	335,00		

07 S74 N/E D. ORANGE 03.2023

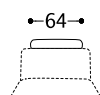

1MN2PTD2

KOPFLEHNE 64 CM (GEEIGNET FÜR ZWEI SITZER SOFA, ZWEI SITZER SMALL SOFA, SESSEL UND MERIDIENNE)

1MN2PTD2		2MN2PTD2	
Cat.3	134,00	Cat.E	182,00
Cat.4	146,00	Cat.F	225,00
Cat.5	154,00	Cat.G	245,00
Cat.6	163,00	Cat.H	275,00
Cat.7	175,00	Cat.I	331,00
Cat.8	187,00	Cat.L	357,00
Cat.9	223,00	Cat.M	390,00
Cat.10	246,00		
Cat.11	273,00		
Cat.12	299,00		
Cat.13	332,00		

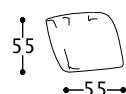

1MN2CJ

RÜCKENKISSEN JOLLY

1MN2CJ		2MN2CJ	
Cat.3	92,00	Cat.E	133,00
Cat.4	104,00	Cat.F	190,00
Cat.5	113,00	Cat.G	216,00
Cat.6	122,00	Cat.H	254,00
Cat.7	134,00	Cat.I	328,00
Cat.8	146,00	Cat.L	361,00
Cat.9	181,00	Cat.M	404,00
Cat.10	205,00		
Cat.11	231,00		
Cat.12	258,00		
Cat.13	291,00		

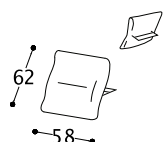

1MN2CSS

KISSEN SPECIAL

1MN2CSS		2MN2CSS	
Cat.3	339,00	Cat.E	377,00
Cat.4	364,00	Cat.F	454,00
Cat.5	383,00	Cat.G	489,00
Cat.6	402,00	Cat.H	540,00
Cat.7	427,00	Cat.I	639,00
Cat.8	452,00	Cat.L	684,00
Cat.9	528,00	Cat.M	741,00
Cat.10	578,00		
Cat.11	635,00		
Cat.12	691,00		
Cat.13	760,00		

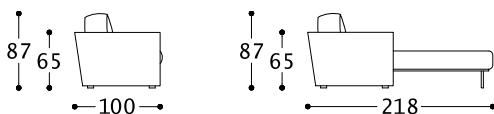

07 S74 N/E D. ORANGE 03.2023

BEZÜGE SIND ABNEHMBAR. DIESES MODELL KANN NUR MIT EINZIGEN STOFF BEZOGEN WERDEN. GESTREIFTE STOFFE ODER STOFFE MIT MUSTERN EIGNEN SICH NICHT FÜR DIESES MODELL. LIEFERBAR AUCH AUS KUNSTLEDER (NICHT ABNEHMBAR). ARTIKEL MIT HOHER LATTENROST HABEN DIE SITZHÖHE 53 CM.; ARTIKEL MIT NIEDRIGER LATTENROST HABEN DIE SITZHÖHE 48 CM. DAS MODELL IST MIT BOX FÜR KISSEN VERSEHEN. DIE ELEMENTE WERDEN MIT KARTON VERPACKT, ZERLEGT GELIEFERT UND IN 3 KOLLI GETEILT: SOFA, LATTENROST UND MATRATZE, ARMLEHNEN.

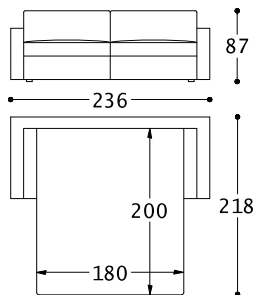

1MTPT3MEBM814

DREISITZSOFA MAXI MIT NIEDRIGEM ELEKTROGESCHWEISSTEM LATTENROST UND FEDERKERNMATRATZE, H. 14 CM

1MTPT3MEBM814

Cat.3	5.225,00
Cat.4	5.405,00
Cat.5	5.762,00
Cat.6	5.903,00
Cat.7	6.090,00
Cat.8	6.278,00
Cat.9	6.840,00
Cat.10	7.215,00
Cat.11	7.637,00
Cat.12	8.059,00
Cat.13	8.575,00

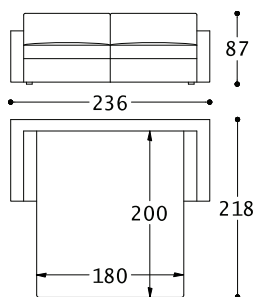

1MTPT3MEBP812

DREISITZSOFA MAXI MIT NIEDRIGEM ELEKTROGESCHWEISSTEM LATTENROST UND POLYURETHANSCHAUM-MATRATZE, H. 12 CM

1MTPT3MEBP812

Cat.3	5.278,00
Cat.4	5.458,00
Cat.5	5.817,00
Cat.6	5.958,00
Cat.7	6.145,00
Cat.8	6.333,00
Cat.9	6.896,00
Cat.10	7.271,00
Cat.11	7.693,00
Cat.12	8.115,00
Cat.13	8.630,00

07 S74 N/E D. ORANGE 03.2023

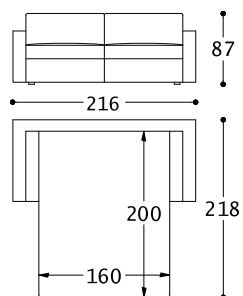

1MTPT3ADI618

DREISITZSOFA MIT HOHEM LATTENROST,
BREITEN DAUBEN UND
TASCHENFEDERKERNMATRATZE, H. 17 CM

1MTPT3ADI618

Cat.3	5.251,00
Cat.4	5.421,00
Cat.5	5.771,00
Cat.6	5.904,00
Cat.7	6.081,00
Cat.8	6.259,00
Cat.9	6.790,00
Cat.10	7.145,00
Cat.11	7.543,00
Cat.12	7.942,00
Cat.13	8.430,00

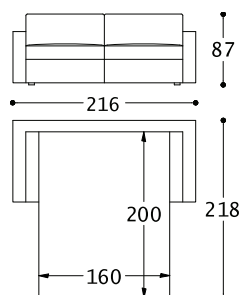

1MTPT3ADM618

DREISITZSOFA MIT HOHEM LATTENROST,
BREITEN DAUBEN UND
FEDERKERNMATRATZE, H. 17 CM

1MTPT3ADM618

Cat.3	4.809,00
Cat.4	4.979,00
Cat.5	5.311,00
Cat.6	5.444,00
Cat.7	5.621,00
Cat.8	5.798,00
Cat.9	6.330,00
Cat.10	6.684,00
Cat.11	7.083,00
Cat.12	7.482,00
Cat.13	7.969,00

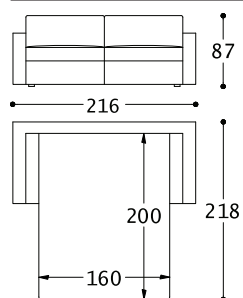

1MTPT3EAI618

DREISITZSOFA MIT HOHEM
ELEKTROGESCHWEISSTEM LATTENROST
UND TASCHENFEDERKERNMATRATZE, H.
17 CM

1MTPT3EAI618

Cat.3	5.152,00
Cat.4	5.323,00
Cat.5	5.669,00
Cat.6	5.801,00
Cat.7	5.979,00
Cat.8	6.156,00
Cat.9	6.688,00
Cat.10	7.042,00
Cat.11	7.441,00
Cat.12	7.839,00
Cat.13	8.327,00

07 S74 N/E D. ORANGE 03.2023

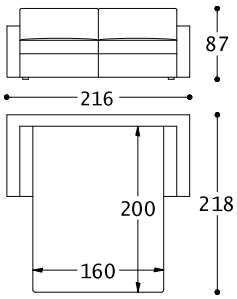

1MTPT3EAM618

DREISITZSOFA MIT HOHEM
ELEKTROGESCHWEISSTEM LATTENROST
UND FEDERKERNMATRATZE, H. 17 CM

1MTPT3EAM618

Cat.3	4.675,00
Cat.4	4.846,00
Cat.5	5.173,00
Cat.6	5.305,00
Cat.7	5.483,00
Cat.8	5.660,00
Cat.9	6.192,00
Cat.10	6.546,00
Cat.11	6.945,00
Cat.12	7.343,00
Cat.13	7.831,00

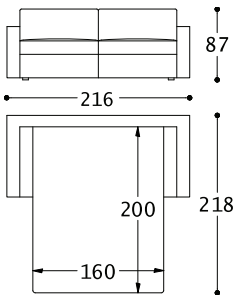

1MTPT3EBM614

DREISITZSOFA MIT NIEDRIGEM
ELEKTROGESCHWEISSTEM LATTENROST
UND FEDERKERNMATRATZE, H. 14 CM

1MTPT3EBM614

Cat.3	4.790,00
Cat.4	4.960,00
Cat.5	5.292,00
Cat.6	5.425,00
Cat.7	5.602,00
Cat.8	5.779,00
Cat.9	6.311,00
Cat.10	6.665,00
Cat.11	7.064,00
Cat.12	7.463,00
Cat.13	7.950,00

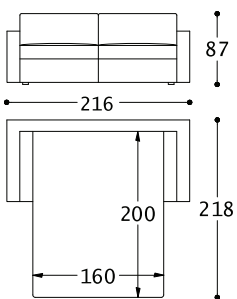

1MTPT3EBP612

DREISITZSOFA MIT NIEDRIGEM
ELEKTROGESCHWEISSTEM LATTENROST
UND POLYURETHANSCHAUM-MATRATZE,
H. 12 CM

1MTPT3EBP612

Cat.3	4.929,00
Cat.4	5.099,00
Cat.5	5.436,00
Cat.6	5.569,00
Cat.7	5.746,00
Cat.8	5.923,00
Cat.9	6.455,00
Cat.10	6.809,00
Cat.11	7.208,00
Cat.12	7.607,00
Cat.13	8.094,00

07 S74 N/E D. ORANGE 03.2023

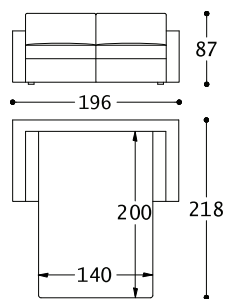

1MTPT2ADI418

ZWEISITZSOFA MIT HOHEM LATTENROST,
BREITEN DAUBEN UND
TASCHENFEDERKERNMATRATZE, H. 17 CM

1MTPT2ADI418

Cat.3	5.052,00
Cat.4	5.222,00
Cat.5	5.564,00
Cat.6	5.697,00
Cat.7	5.874,00
Cat.8	6.051,00
Cat.9	6.583,00
Cat.10	6.937,00
Cat.11	7.336,00
Cat.12	7.735,00
Cat.13	8.222,00

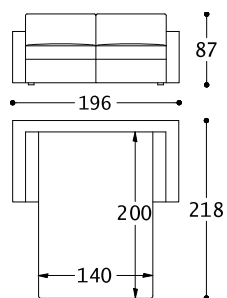

1MTPT2ADM418

ZWEISITZSOFA MIT HOHEM LATTENROST,
BREITEN DAUBEN UND
FEDERKERNMATRATZE, H. 17 CM

1MTPT2ADM418

Cat.3	4.552,00
Cat.4	4.722,00
Cat.5	5.044,00
Cat.6	5.177,00
Cat.7	5.354,00
Cat.8	5.532,00
Cat.9	6.063,00
Cat.10	6.418,00
Cat.11	6.816,00
Cat.12	7.215,00
Cat.13	7.703,00

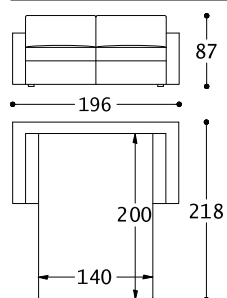

1MTPT2EAI418

ZWEISITZSOFA MIT HOHEM
ELEKTROGESCHWEISSTEM LATTENROST
UND TASCHENFEDERKERNMATRATZE, H.
17 CM

1MTPT2EAI418

Cat.3	4.903,00
Cat.4	5.074,00
Cat.5	5.410,00
Cat.6	5.543,00
Cat.7	5.720,00
Cat.8	5.897,00
Cat.9	6.429,00
Cat.10	6.783,00
Cat.11	7.182,00
Cat.12	7.581,00
Cat.13	8.068,00

07 S74 N/E D. ORANGE 03.2023

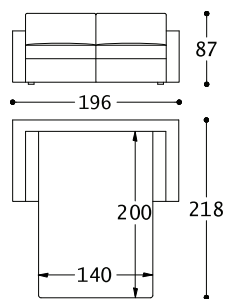

1MTPT2EAM418

ZWEISITZSOFA MIT HOHEM
ELEKTROGESCHWEISSTEM LATTENROST
UND FEDERKERNMATRATZE, H. 17 CM

1MTPT2EAM418

Cat.3	4.369,00
Cat.4	4.540,00
Cat.5	4.854,00
Cat.6	4.987,00
Cat.7	5.165,00
Cat.8	5.342,00
Cat.9	5.873,00
Cat.10	6.228,00
Cat.11	6.627,00
Cat.12	7.025,00
Cat.13	7.513,00

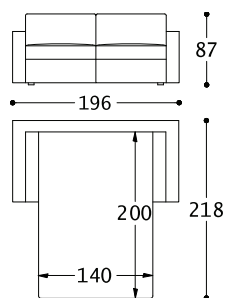

1MTPT2EBM414

ZWEISITZSOFA MIT NIEDRIGEM
ELEKTROGESCHWEISSTEM LATTENROST
UNDFEDERKERNMATRATZE, H. 14 CM

1MTPT2EBM414

Cat.3	4.417,00
Cat.4	4.588,00
Cat.5	4.904,00
Cat.6	5.037,00
Cat.7	5.214,00
Cat.8	5.391,00
Cat.9	5.923,00
Cat.10	6.277,00
Cat.11	6.676,00
Cat.12	7.075,00
Cat.13	7.562,00

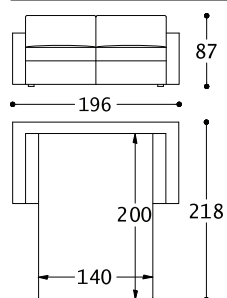

1MTPT2EBP412

ZWEISITZSOFA MIT NIEDRIGEM
ELEKTROGESCHWEISSTEM LATTENROST
UND POLYURETHANSCHAUM-MATRATZE,
H. 12 CM

1MTPT2EBP412

Cat.3	4.463,00
Cat.4	4.633,00
Cat.5	4.951,00
Cat.6	5.084,00
Cat.7	5.262,00
Cat.8	5.439,00
Cat.9	5.970,00
Cat.10	6.325,00
Cat.11	6.724,00
Cat.12	7.122,00
Cat.13	7.610,00

07 S74 N/E D. ORANGE 03.2023

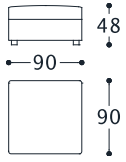

HOCKER

1MTPPOUFF

1MTPPOUFF

Cat.3	893,00
Cat.4	949,00
Cat.5	1.032,00
Cat.6	1.076,00
Cat.7	1.135,00
Cat.8	1.194,00
Cat.9	1.371,00
Cat.10	1.489,00
Cat.11	1.622,00
Cat.12	1.755,00
Cat.13	1.918,00

Auswahl (Marmor): Mar.NATURAL DOVER WHITE (X1), Mar.MAGIC BROWN (X1), Mar.ARBESQUE PURPLE (X1), Mar.DAINO REALE (X2), Mar.MARQUINA BLACK (X2), Mar.EMPERADOR BROWN (X3), Mar.NATURAL TRAVERTINO (X3), Mar.CALACATTA WHITE (X4), Mar.VERDE ISSORIE (X4), Mar.CREAM CALACATTA (X4). LACKIERTBEARBEITUNG- FARBEN ZUR AUSWAHL: BORDEAUX, GREEN, BLUE, GREY, IVORY, DOVE GREY, MINK BROWN, RUST, MIST, CREAM, DARK BROWN, BURGUNDY, SNOW, ASH GREY. BASIS AUS METALL- Auswahl: FRENCH BRONZE, GUN METAL, POLIERT BRÜNIERT.

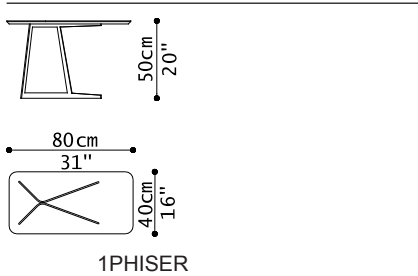
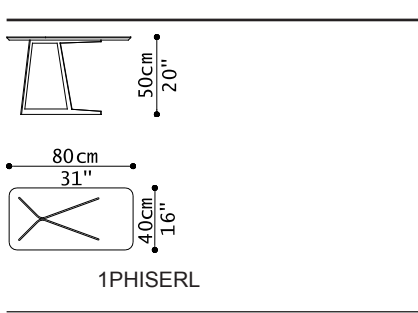
 <p>1PHISER</p>	<p>SEITENTISCH MIT TOP AUS MARMOR, BASIS AUS METALL</p>	<table border="1"> <thead> <tr> <th colspan="2">1PHISER</th> </tr> </thead> <tbody> <tr> <td>X1</td> <td>1.707,00</td> </tr> <tr> <td>X2</td> <td>1.384,00</td> </tr> <tr> <td>X3</td> <td>1.526,00</td> </tr> <tr> <td>X4</td> <td>1.707,00</td> </tr> </tbody> </table>	1PHISER		X1	1.707,00	X2	1.384,00	X3	1.526,00	X4	1.707,00
1PHISER												
X1	1.707,00											
X2	1.384,00											
X3	1.526,00											
X4	1.707,00											
 <p>1PHISERL</p>	<p>SEITENTISCH MIT TOP LACKIERT, BASIS AUS METALL</p>	<table border="1"> <thead> <tr> <th colspan="2">1PHISERL</th> </tr> </thead> <tbody> <tr> <td>Z1</td> <td>1.151,00</td> </tr> </tbody> </table>	1PHISERL		Z1	1.151,00						
1PHISERL												
Z1	1.151,00											

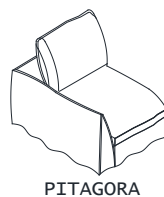

PITAGORA

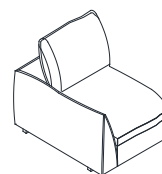

PITAGORA 2

07 S74 N/E D. ORANGE 03.2023

DIE STOFF-VERSION IST ABNEHMBAR UND MAN KANN NUR MIT EINEM EINZIGEN STOFF BEZIEHEN. ES IST MIT ZWEI NAEHE VERSIONEN VERFUEGBAR. DIE VERSION A MIT GROSSE BORDÜRE KANN MIT TON AUF TON ODER MIT EINEM ANDEREN STOFF BEZOGEN WERDEN VORSICHT: IM FALLE DASS DIE BORDÜRE IM KONTRASTFARBE IST, IST EINE CHEMISCHE REINIGUNG ERFORDERLICH. MODELL LIEFERBAR AUCH MIT "PIZZICATA" NÄHT (DIE VERSION B). LEDER-VERSION: BORDÜRE "ROHZUSCHNITT". MODELL AUS KUNSTLEDER NICHT VERFÜGBAR. NOSAG METALLSPRUNGFEDERN. DAS MODELL IST AUCH OHNE ROCK VERFÜGBAR (MODELL PITAGORA 2 KODE PI2). UM DIE BESTELLUNG DES SOFAELEMENTE ZU ERTEILEN, MUSS MAN DEN KODE "PTG/PIT" MIT DEM KODE "PI2" ERSETZEN. ZB.: 1PTGD3/2PITD3= Dreisitzer-Sofa mod. PITAGORA; 1PI2D3/2PI2D3=Dreisitzer-Sofa mod. PITAGORA 2.

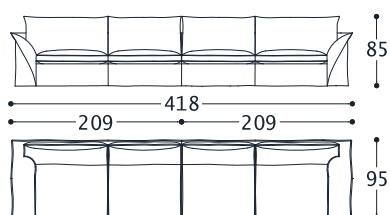

OPTGC1

1 DREI SITZER SOFA ARMLEHNE RECHTS
1 DREI SITZER SOFA ARMLEHNE LINKS

OPTGC1		OPITC1	
Cat.3	6.154,00	Cat.E	7.388,00
Cat.4	6.576,00	Cat.F	9.134,00
Cat.5	6.892,00	Cat.G	9.934,00
Cat.6	7.208,00	Cat.H	11.096,00
Cat.7	7.630,00	Cat.I	13.350,00
Cat.8	8.052,00	Cat.L	14.368,00
Cat.9	9.318,00	Cat.M	15.678,00
Cat.10	10.160,00		
Cat.11	11.110,00		
Cat.12	12.058,00		
Cat.13	13.218,00		

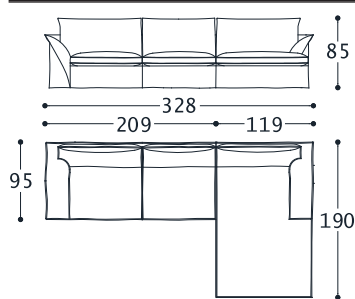

OPTGC3

1 MAXI CHAISE LONGUE ARMLEHNE RECHTS
1 DREI SITZER SOFA ARMLEHNE LINKS

OPTGC3		OPITC3	
Cat.3	6.094,00	Cat.E	7.277,00
Cat.4	6.491,00	Cat.F	8.882,00
Cat.5	6.789,00	Cat.G	9.618,00
Cat.6	7.086,00	Cat.H	10.688,00
Cat.7	7.483,00	Cat.I	12.762,00
Cat.8	7.881,00	Cat.L	13.698,00
Cat.9	9.072,00	Cat.M	14.903,00
Cat.10	9.865,00		
Cat.11	10.759,00		
Cat.12	11.652,00		
Cat.13	12.744,00		

07 S74 N/E D. ORANGE 03.2023

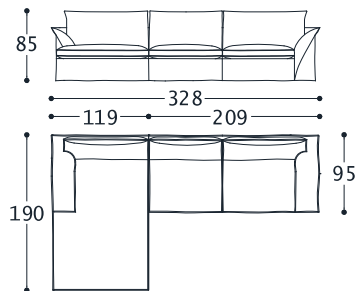

OPTGC9

1 MAXI CHAISE LONGUE ARMLEHNE LINKS
1 DREI SITZER SOFA ARMLEHNE RECHTS

OPTGC9	
Cat.3	6.094,00
Cat.4	6.491,00
Cat.5	6.789,00
Cat.6	7.086,00
Cat.7	7.483,00
Cat.8	7.881,00
Cat.9	9.072,00
Cat.10	9.865,00
Cat.11	10.759,00
Cat.12	11.652,00
Cat.13	12.744,00

OPITC9	
Cat.E	7.277,00
Cat.F	8.882,00
Cat.G	9.618,00
Cat.H	10.688,00
Cat.I	12.762,00
Cat.L	13.698,00
Cat.M	14.903,00

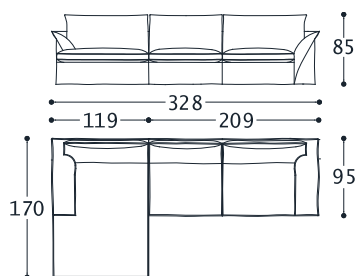

OPTGC2

1 CHAISE LONGUE ARMLEHNE LINKS
1 DREI SITZER SOFA ARMLEHNE RECHTS

OPTGC2	
Cat.3	5.687,00
Cat.4	6.072,00
Cat.5	6.361,00
Cat.6	6.650,00
Cat.7	7.035,00
Cat.8	7.421,00
Cat.9	8.577,00
Cat.10	9.347,00
Cat.11	10.215,00
Cat.12	11.081,00
Cat.13	12.141,00

OPITC2	
Cat.E	6.828,00
Cat.F	8.377,00
Cat.G	9.087,00
Cat.H	10.119,00
Cat.I	12.119,00
Cat.L	13.023,00
Cat.M	14.185,00

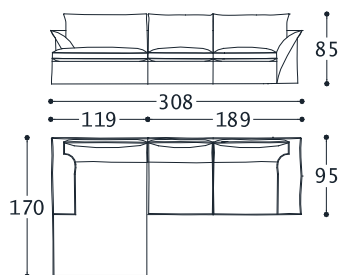

OPTGC10

1 CHAISE LONGUE ARMLEHNE LINKS
1 ZWEI SITZER MAXI SOFA ARMLEHNE RECHTS

OPTGC10	
Cat.3	5.440,00
Cat.4	5.823,00
Cat.5	6.111,00
Cat.6	6.399,00
Cat.7	6.782,00
Cat.8	7.167,00
Cat.9	8.318,00
Cat.10	9.086,00
Cat.11	9.950,00
Cat.12	10.813,00
Cat.13	11.869,00

OPITC10	
Cat.E	6.483,00
Cat.F	7.948,00
Cat.G	8.620,00
Cat.H	9.597,00
Cat.I	11.490,00
Cat.L	12.346,00
Cat.M	13.445,00

07 S74 N/E D. ORANGE 03.2023

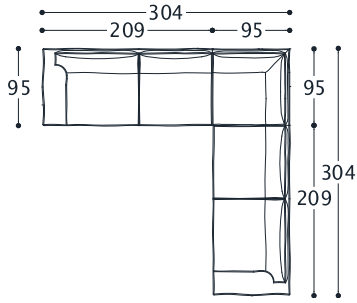

OPTGC4

1 ECHELEMENT
1 DREI SITZER SOFA ARMLEHNE RECHTS
1 DREI SITZER SOFA ARMLEHNE LINKS

OPTGC4		OPITC4	
Cat.3	7.952,00	Cat.E	9.816,00
Cat.4	8.525,00	Cat.F	12.156,00
Cat.5	8.954,00	Cat.G	13.228,00
Cat.6	9.382,00	Cat.H	14.785,00
Cat.7	9.955,00	Cat.I	17.805,00
Cat.8	10.527,00	Cat.L	19.169,00
Cat.9	12.245,00	Cat.M	20.924,00
Cat.10	13.388,00		
Cat.11	14.677,00		
Cat.12	15.963,00		
Cat.13	17.537,00		

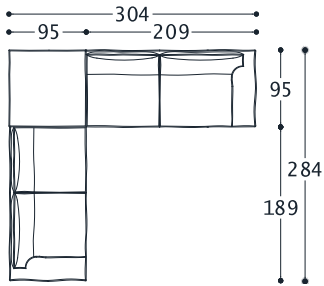

OPTGC8

1 ZWEI SITZER MAXI SOFA ARMLEHNE LINKS
1 DREI SITZER SOFA ARMLEHNE RECHTS
1 QUADRATISCHER HOCKER

OPTGC8		OPITC8	
Cat.3	7.180,00	Cat.E	8.474,00
Cat.4	7.696,00	Cat.F	10.399,00
Cat.5	8.083,00	Cat.G	11.282,00
Cat.6	8.469,00	Cat.H	12.565,00
Cat.7	8.985,00	Cat.I	15.053,00
Cat.8	9.502,00	Cat.L	16.177,00
Cat.9	11.051,00	Cat.M	17.622,00
Cat.10	12.083,00		
Cat.11	13.245,00		
Cat.12	14.406,00		
Cat.13	15.826,00		

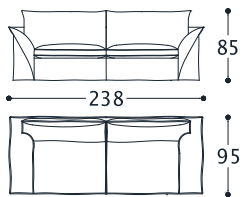

1PTGD3

DREI SITZER SOFA

1PTGD3		2PITD3	
Cat.3	3.385,00	Cat.E	4.089,00
Cat.4	3.609,00	Cat.F	5.071,00
Cat.5	3.776,00	Cat.G	5.521,00
Cat.6	3.944,00	Cat.H	6.175,00
Cat.7	4.168,00	Cat.I	7.443,00
Cat.8	4.392,00	Cat.L	8.015,00
Cat.9	5.064,00	Cat.M	8.751,00
Cat.10	5.512,00		
Cat.11	6.016,00		
Cat.12	6.520,00		
Cat.13	7.135,00		

07 S74 N/E D. ORANGE 03.2023

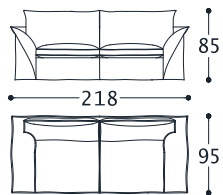

1PTGD2M

ZWEI SITZER MAXI SOFA

1PTGD2M		2PITD2M	
Cat.3	3.121,00	Cat.E	3.730,00
Cat.4	3.343,00	Cat.F	4.629,00
Cat.5	3.510,00	Cat.G	5.041,00
Cat.6	3.677,00	Cat.H	5.640,00
Cat.7	3.899,00	Cat.I	6.801,00
Cat.8	4.122,00	Cat.L	7.325,00
Cat.9	4.789,00	Cat.M	7.999,00
Cat.10	5.234,00		
Cat.11	5.735,00		
Cat.12	6.235,00		
Cat.13	6.847,00		

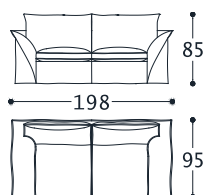

1PTGD2

ZWEI SITZER SOFA

1PTGD2		2PITD2	
Cat.3	2.984,00	Cat.E	3.500,00
Cat.4	3.205,00	Cat.F	4.318,00
Cat.5	3.371,00	Cat.G	4.693,00
Cat.6	3.536,00	Cat.H	5.239,00
Cat.7	3.757,00	Cat.I	6.295,00
Cat.8	3.978,00	Cat.L	6.772,00
Cat.9	4.641,00	Cat.M	7.386,00
Cat.10	5.083,00		
Cat.11	5.581,00		
Cat.12	6.078,00		
Cat.13	6.686,00		

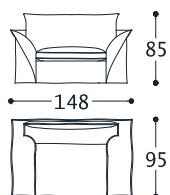

1PTGPL

LARGE SESSEL

1PTGPL		2PITPL	
Cat.3	2.323,00	Cat.E	2.794,00
Cat.4	2.483,00	Cat.F	3.431,00
Cat.5	2.603,00	Cat.G	3.723,00
Cat.6	2.723,00	Cat.H	4.148,00
Cat.7	2.883,00	Cat.I	4.971,00
Cat.8	3.043,00	Cat.L	5.342,00
Cat.9	3.523,00	Cat.M	5.820,00
Cat.10	3.843,00		
Cat.11	4.203,00		
Cat.12	4.563,00		
Cat.13	5.002,00		

07 S74 N/E D. ORANGE 03.2023

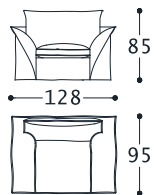

1PTGP

SESSEL

1PTGP		2PITP	
Cat.3	2.034,00	Cat.E	2.449,00
Cat.4	2.183,00	Cat.F	3.016,00
Cat.5	2.296,00	Cat.G	3.276,00
Cat.6	2.408,00	Cat.H	3.654,00
Cat.7	2.558,00	Cat.I	4.387,00
Cat.8	2.708,00	Cat.L	4.717,00
Cat.9	3.157,00	Cat.M	5.143,00
Cat.10	3.456,00		
Cat.11	3.793,00		
Cat.12	4.130,00		
Cat.13	4.542,00		

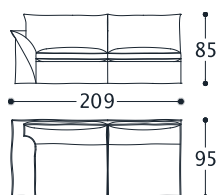

1PTGD3SX

DREI SITZER SOFA ARMLEHNE LINKS
DREI SITZER SOFA ARMLEHNE RECHTS

1PTGD3SX		2PITD3SX	
1PTGD3DX		2PITD3DX	
Cat.3	3.077,00	Cat.E	3.694,00
Cat.4	3.288,00	Cat.F	4.567,00
Cat.5	3.446,00	Cat.G	4.967,00
Cat.6	3.604,00	Cat.H	5.548,00
Cat.7	3.815,00	Cat.I	6.675,00
Cat.8	4.026,00	Cat.L	7.184,00
Cat.9	4.659,00	Cat.M	7.839,00
Cat.10	5.080,00		
Cat.11	5.555,00		
Cat.12	6.029,00		
Cat.13	6.609,00		

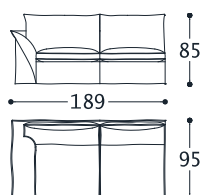

1PTGD2MSX

ZWEI SITZER MAXI SOFA ARMLEHNE LINKS
ZWEI SITZER MAXI SOFA ARMLEHNE RECHTS

1PTGD2MSX		2PITD2MSX	
1PTGD2MDX		2PITD2MDX	
Cat.3	2.830,00	Cat.E	3.349,00
Cat.4	3.039,00	Cat.F	4.138,00
Cat.5	3.196,00	Cat.G	4.500,00
Cat.6	3.353,00	Cat.H	5.026,00
Cat.7	3.562,00	Cat.I	6.046,00
Cat.8	3.772,00	Cat.L	6.507,00
Cat.9	4.400,00	Cat.M	7.099,00
Cat.10	4.819,00		
Cat.11	5.290,00		
Cat.12	5.761,00		
Cat.13	6.337,00		

07 S74 N/E D. ORANGE 03.2023

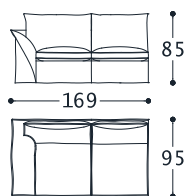

1PTGD2SX

ZWEI SITZER SOFA ARMLEHNE LINKS
ZWEI SITZER SOFA ARMLEHNE RECHTS

1PTGD2SX		2PITD2SX	
1PTGD2DX		2PITD2DX	
Cat.3	2.691,00	Cat.E	3.121,00
Cat.4	2.899,00	Cat.F	3.834,00
Cat.5	3.055,00	Cat.G	4.161,00
Cat.6	3.211,00	Cat.H	4.637,00
Cat.7	3.419,00	Cat.I	5.558,00
Cat.8	3.627,00	Cat.L	5.974,00
Cat.9	4.251,00	Cat.M	6.509,00
Cat.10	4.666,00		
Cat.11	5.134,00		
Cat.12	5.602,00		
Cat.13	6.174,00		

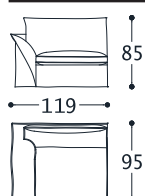

1PTGPLSX

LARGE SESSEL ARMLEHNE LINKS
LARGE SESSEL ARMLEHNE RECHTS

1PTGPLSX		2PITPLSX	
1PTGPLDX		2PITPLDX	
Cat.3	1.982,00	Cat.E	2.370,00
Cat.4	2.122,00	Cat.F	2.893,00
Cat.5	2.227,00	Cat.G	3.133,00
Cat.6	2.331,00	Cat.H	3.482,00
Cat.7	2.471,00	Cat.I	4.158,00
Cat.8	2.610,00	Cat.L	4.464,00
Cat.9	3.029,00	Cat.M	4.856,00
Cat.10	3.308,00		
Cat.11	3.623,00		
Cat.12	3.937,00		
Cat.13	4.320,00		

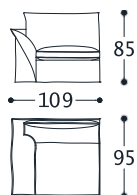

1PTGPMSX

MAXI SESSEL ARMLEHNE LINKS
MAXI SESSEL ARMLEHNE RECHTS

1PTGPMSX		2PITPMSX	
1PTGPMDX		2PITPMDX	
Cat.3	1.910,00	Cat.E	2.246,00
Cat.4	2.049,00	Cat.F	2.728,00
Cat.5	2.152,00	Cat.G	2.949,00
Cat.6	2.256,00	Cat.H	3.270,00
Cat.7	2.394,00	Cat.I	3.893,00
Cat.8	2.532,00	Cat.L	4.174,00
Cat.9	2.947,00	Cat.M	4.535,00
Cat.10	3.223,00		
Cat.11	3.534,00		
Cat.12	3.844,00		
Cat.13	4.224,00		

07 S74 N/E D. ORANGE 03.2023

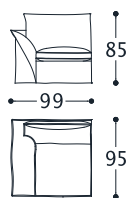

1PTGPSX

SESSEL ARMLEHNE LINKS
SESSEL ARMLEHNE RECHTS

1PTGPSX		2PITPSX	
1PTGPDIX		2PITPDX	
Cat.3	1.715,00	Cat.E	2.006,00
Cat.4	1.852,00	Cat.F	2.447,00
Cat.5	1.955,00	Cat.G	2.649,00
Cat.6	2.057,00	Cat.H	2.942,00
Cat.7	2.194,00	Cat.I	3.512,00
Cat.8	2.330,00	Cat.L	3.769,00
Cat.9	2.740,00	Cat.M	4.099,00
Cat.10	3.014,00		
Cat.11	3.321,00		
Cat.12	3.629,00		
Cat.13	4.005,00		

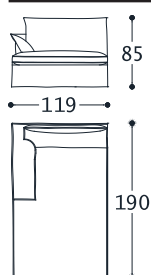

1PTGCHLMSX

MAXI CHAISE LONGUE ARMLEHNE LINKS
MAXI CHAISE LONGUE ARMLEHNE
RECHTS

1PTGCHLMSX		2PITCHLMSX	
1PTGCHLMDX		2PITCHLMDX	
Cat.3	3.017,00	Cat.E	3.583,00
Cat.4	3.203,00	Cat.F	4.315,00
Cat.5	3.343,00	Cat.G	4.651,00
Cat.6	3.482,00	Cat.H	5.140,00
Cat.7	3.668,00	Cat.I	6.087,00
Cat.8	3.855,00	Cat.L	6.514,00
Cat.9	4.413,00	Cat.M	7.064,00
Cat.10	4.785,00		
Cat.11	5.204,00		
Cat.12	5.623,00		
Cat.13	6.135,00		

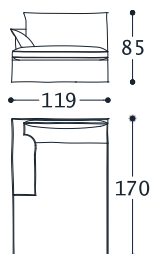

1PTGCHLSX

CHAISE LONGUE ARMLEHNE LINKS
CHAISE LONGUE ARMLEHNE RECHTS

1PTGCHLSX		2PITCHLSX	
1PTGCHLDX		2PITCHLDX	
Cat.3	2.610,00	Cat.E	3.134,00
Cat.4	2.784,00	Cat.F	3.810,00
Cat.5	2.915,00	Cat.G	4.120,00
Cat.6	3.046,00	Cat.H	4.571,00
Cat.7	3.220,00	Cat.I	5.444,00
Cat.8	3.395,00	Cat.L	5.839,00
Cat.9	3.918,00	Cat.M	6.346,00
Cat.10	4.267,00		
Cat.11	4.660,00		
Cat.12	5.052,00		
Cat.13	5.532,00		

07 S74 N/E D. ORANGE 03.2023

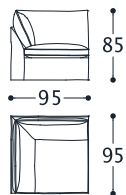

1PTGAR

ECKELEMENT

1PTGAR		2PITAR	
Cat.3	1.798,00	Cat.E	2.428,00
Cat.4	1.949,00	Cat.F	3.022,00
Cat.5	2.062,00	Cat.G	3.294,00
Cat.6	2.174,00	Cat.H	3.689,00
Cat.7	2.325,00	Cat.I	4.455,00
Cat.8	2.475,00	Cat.L	4.801,00
Cat.9	2.927,00	Cat.M	5.246,00
Cat.10	3.228,00		
Cat.11	3.567,00		
Cat.12	3.905,00		
Cat.13	4.319,00		

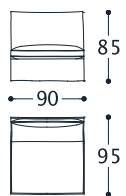

1PTGPL1

ZENTRAL LARGE SESSEL

1PTGPL1		2PITPL1	
Cat.3	1.634,00	Cat.E	1.917,00
Cat.4	1.761,00	Cat.F	2.331,00
Cat.5	1.856,00	Cat.G	2.521,00
Cat.6	1.951,00	Cat.H	2.797,00
Cat.7	2.077,00	Cat.I	3.333,00
Cat.8	2.204,00	Cat.L	3.574,00
Cat.9	2.583,00	Cat.M	3.885,00
Cat.10	2.836,00		
Cat.11	3.121,00		
Cat.12	3.405,00		
Cat.13	3.753,00		

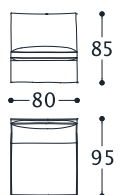

1PTGPM1

MAXI ZENTRAL SESSEL

1PTGPM1		2PITPM1	
Cat.3	1.573,00	Cat.E	1.694,00
Cat.4	1.698,00	Cat.F	2.069,00
Cat.5	1.792,00	Cat.G	2.241,00
Cat.6	1.886,00	Cat.H	2.491,00
Cat.7	2.011,00	Cat.I	2.975,00
Cat.8	2.136,00	Cat.L	3.194,00
Cat.9	2.511,00	Cat.M	3.476,00
Cat.10	2.761,00		
Cat.11	3.042,00		
Cat.12	3.324,00		
Cat.13	3.668,00		

07 S74 N/E D. ORANGE 03.2023

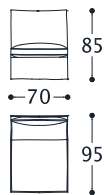

ZENTRAL SESSEL

1PTGP1

1PTGP1		2PITP1	
Cat.3	1.372,00	Cat.E	1.573,00
Cat.4	1.495,00	Cat.F	1.909,00
Cat.5	1.588,00	Cat.G	2.063,00
Cat.6	1.681,00	Cat.H	2.287,00
Cat.7	1.804,00	Cat.I	2.720,00
Cat.8	1.928,00	Cat.L	2.916,00
Cat.9	2.299,00	Cat.M	3.168,00
Cat.10	2.546,00		
Cat.11	2.824,00		
Cat.12	3.102,00		
Cat.13	3.442,00		

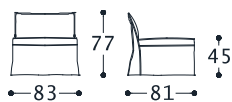

SPEZIEL SESSEL

1PTGPSP

1PTGPSP		2PITPSP	
Cat.3	1.247,00	Cat.E	1.326,00
Cat.4	1.345,00	Cat.F	1.562,00
Cat.5	1.418,00	Cat.G	1.670,00
Cat.6	1.491,00	Cat.H	1.827,00
Cat.7	1.588,00	Cat.I	2.131,00
Cat.8	1.686,00	Cat.L	2.269,00
Cat.9	1.978,00	Cat.M	2.445,00
Cat.10	2.173,00		
Cat.11	2.392,00		
Cat.12	2.611,00		
Cat.13	2.879,00		

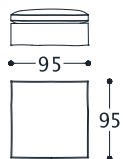

QUADRATISCHER HOCKER

1PTGPFFQ

1PTGPFFQ		2PITPFFQ	
Cat.3	1.273,00	Cat.E	1.431,00
Cat.4	1.369,00	Cat.F	1.694,00
Cat.5	1.441,00	Cat.G	1.815,00
Cat.6	1.512,00	Cat.H	1.991,00
Cat.7	1.608,00	Cat.I	2.332,00
Cat.8	1.704,00	Cat.L	2.486,00
Cat.9	1.992,00	Cat.M	2.684,00
Cat.10	2.184,00		
Cat.11	2.400,00		
Cat.12	2.616,00		
Cat.13	2.880,00		

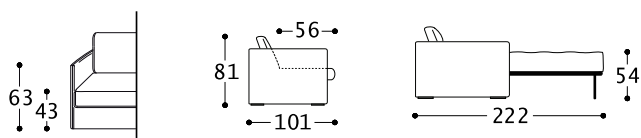

07 S74 N/E D. ORANGE 03.2023

BEZÜGE SIND ABNEHMBAR. DIESES MODELL KANN MIT UNTERSCHIEDLICHEN STOFFE FUER RUECK-SITZKISSEN UND CHASSIS BEZOGEN WERDEN. SITZ UND RÜCKENKISSEN WERDEN MIT DEM SELBEN STOFF BEZOGEN. GESTREIFTE STOFFE ODER STOFFE MIT MUSTERN EIGNEN SICH NUR FÜR RÜCKENKISSEN. KEDER AUS RIBSBAND-GROSGRAIN WAHLFREI (SIEHE GROSGRAIN-MUSTER) ODER BORTE IN DEMSELBEN STOFF UND FARBE DES ELEMENTS. WENN DIE BORTE MIT GROSGRAIN IST, EMPFEHLEN WIR DIE BEZÜGE TROCKENZUREINIGEN. LIEFERBAR AUCH AUS KUNSTLEDER (NICHT ABNEHMBAR). SCHLAFSOFAS SIND MIT POLYURETHANSCHAUM MATRATZE GELIEFERT, H. 11 CM. AUF ANFRAGE KANN MAN AUCH MIT MATRATZE "LUX" MIT MEMORY-SCHAUM UND ABNEHMBAR STRETCH STOFF GELIEFERT WERDEN. DIES HAT FOLGENDE AUFSCHLÄGE AUF DER PREISLISTE: MA10053: 160X200X11 EUR.447,00 - MA10054: 140X200X11 EUR.389,00 - MA10055: 120X200X11 EUR.360,00 - MA10057: 75X200X11 EUR.245,00. AUF NACHFRAGE KANN SOFA/SESSEL MIT ZWEI ARMLEHNEN AUCH RAD-KIT VERSEHEN SEIN (KODE ME10171), MIT EINER ERHÖHUNG VON EUR 177,00 AUF DEN LISTENPREIS. DIE ELEMENTE MIT BETT WERDEN ZERLEGT GELIEFERT UND IN 3 KOLLI GETEILT: SOFA MIT LATTENROST, ARMLEHNEN, MATRATZE. DAS SOFA MIT LATTENROST UND DIE ARMLEHNEN WERDEN MIT KARTON VERPACKT. DIE MATRATZE WIRD MIT NYLON VERPACKT.

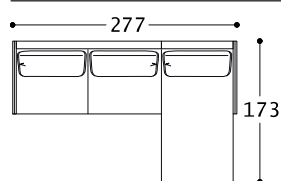

OSPAC1

1 RECHTE DORMEUSE MIT
BEHALTERKASTEN
1 ZWEI SITZER MAXI SOFA ARMLEHNE
LINKS MIT LATTENROST UND
POLYURETHANMATRATZE

OSPAC1

Cat.3	4.931,00
Cat.4	5.127,00
Cat.5	5.274,00
Cat.6	5.422,00
Cat.7	5.619,00
Cat.8	5.815,00
Cat.9	6.406,00
Cat.10	6.798,00
Cat.11	7.241,00
Cat.12	7.684,00
Cat.13	8.224,00

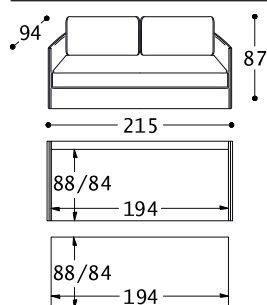

1SPAT3DP2

DREI SITZER SOFA MIT 2
ORTHOPÄDISCHEN LATTENROSTEN UND
POLYURETHANMATRATZE, H. 13 CM

1SPAT3DP2

Cat.3	3.219,00
Cat.4	3.351,00
Cat.5	3.450,00
Cat.6	3.549,00
Cat.7	3.682,00
Cat.8	3.814,00
Cat.9	4.210,00
Cat.10	4.474,00
Cat.11	4.771,00
Cat.12	5.068,00
Cat.13	5.431,00

07 S74 N/E D. ORANGE 03.2023

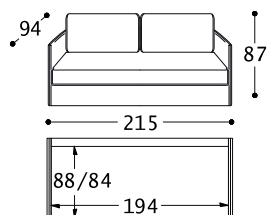

1SPAT3DP1

DREI SITZER SOFA MIT 1 ORTHOPÄDISCHE LATTENROST UND POLYURETHANMATRATZE, H. 13 CM

1SPAT3DP1

Cat.3	2.461,00
Cat.4	2.593,00
Cat.5	2.692,00
Cat.6	2.791,00
Cat.7	2.923,00
Cat.8	3.055,00
Cat.9	3.452,00
Cat.10	3.716,00
Cat.11	4.013,00
Cat.12	4.310,00
Cat.13	4.673,00

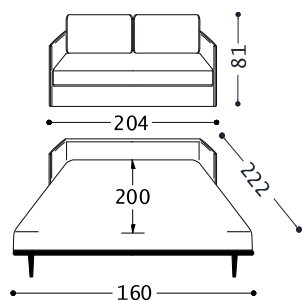

1SPAD3DP

DREI SITZER SOFA MIT LATTENROST UND POLYURETHANMATRATZE

1SPAD3DP

Cat.3	3.486,00
Cat.4	3.611,00
Cat.5	3.706,00
Cat.6	3.800,00
Cat.7	3.926,00
Cat.8	4.051,00
Cat.9	4.428,00
Cat.10	4.680,00
Cat.11	4.962,00
Cat.12	5.245,00
Cat.13	5.591,00

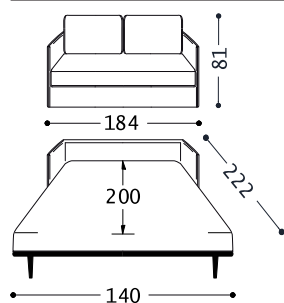

1SPAD2MDP

ZWEI SITZER MAXI SOFA MIT LATTENROST UND POLYURETHANMATRATZE

1SPAD2MDP

Cat.3	3.176,00
Cat.4	3.291,00
Cat.5	3.377,00
Cat.6	3.463,00
Cat.7	3.578,00
Cat.8	3.693,00
Cat.9	4.038,00
Cat.10	4.268,00
Cat.11	4.527,00
Cat.12	4.786,00
Cat.13	5.102,00

07 S74 N/E D. ORANGE 03.2023

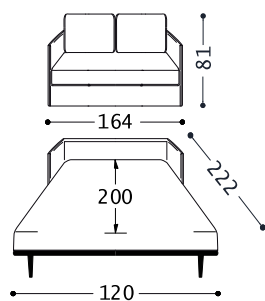

1SPAD2DP

ZWEI SITZER SOFA MIT LATTENROST UND
POLYURETHANMATRATZE

1SPAD2DP

Cat.3	3.000,00
Cat.4	3.109,00
Cat.5	3.190,00
Cat.6	3.272,00
Cat.7	3.380,00
Cat.8	3.489,00
Cat.9	3.815,00
Cat.10	4.032,00
Cat.11	4.277,00
Cat.12	4.521,00
Cat.13	4.820,00

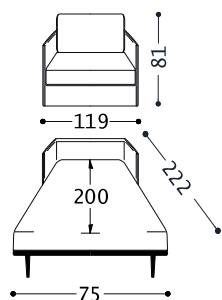

1SPAPDP

SESSEL MIT LATTENROST UND
POLYURETHANMATRATZE

1SPAPDP

Cat.3	2.532,00
Cat.4	2.617,00
Cat.5	2.681,00
Cat.6	2.745,00
Cat.7	2.830,00
Cat.8	2.915,00
Cat.9	3.171,00
Cat.10	3.341,00
Cat.11	3.533,00
Cat.12	3.725,00
Cat.13	3.959,00

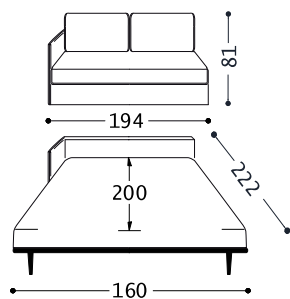

1SPAD3SXDP

DREI SITZER SOFA ARMLEHNE LINKS MIT
LATTENROST UND
POLYURETHANMATRATZE
DREI SITZER SOFA ARMLEHNE RECHTS MIT
LATTENROST UND
POLYURETHANMATRATZE

1SPAD3SXDP

1SPAD3DXDP

Cat.3	3.268,00
Cat.4	3.380,00
Cat.5	3.463,00
Cat.6	3.547,00
Cat.7	3.658,00
Cat.8	3.770,00
Cat.9	4.104,00
Cat.10	4.327,00
Cat.11	4.578,00
Cat.12	4.829,00
Cat.13	5.135,00

07 S74 N/E D. ORANGE 03.2023

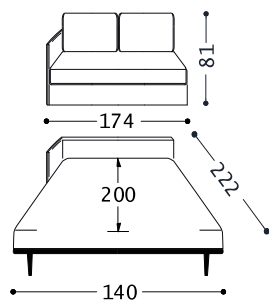

1SPAD2MSXDP

ZWEI SITZER MAXI SOFA ARMLEHNE LINKS
MIT LATTENROST UND
POLYURETHANMATRATZE
ZWEI SITZER MAXI SOFA ARMLEHNE
RECHTS MIT LATTENROST UND
POLYURETHANMATRATZE

1SPAD2MSXDP

1SPAD2MDXDP

Cat.3	2.963,00
Cat.4	3.063,00
Cat.5	3.139,00
Cat.6	3.215,00
Cat.7	3.316,00
Cat.8	3.416,00
Cat.9	3.719,00
Cat.10	3.920,00
Cat.11	4.147,00
Cat.12	4.374,00
Cat.13	4.651,00

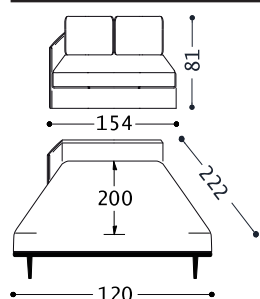

1SPAD2SXDP

ZWEI SITZER SOFA ARMLEHNE LINKS MIT
LATTENROST UND
POLYURETHANMATRATZE
ZWEI SITZER SOFA ARMLEHNE RECHTS MIT
LATTENROST UND
POLYURETHANMATRATZE

1SPAD2SXDP

1SPAD2DXDP

Cat.3	2.783,00
Cat.4	2.877,00
Cat.5	2.948,00
Cat.6	3.019,00
Cat.7	3.113,00
Cat.8	3.208,00
Cat.9	3.491,00
Cat.10	3.680,00
Cat.11	3.892,00
Cat.12	4.105,00
Cat.13	4.364,00

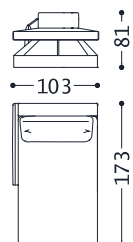

1SPADORMCSX

LINKE DORMEUSE MIT BEHALTERKASTEN
RECHTE DORMEUSE MIT BEHALTERKASTEN

1SPADORMCSX

1SPADORMCDX

Cat.3	1.968,00
Cat.4	2.064,00
Cat.5	2.135,00
Cat.6	2.207,00
Cat.7	2.303,00
Cat.8	2.399,00
Cat.9	2.687,00
Cat.10	2.878,00
Cat.11	3.094,00
Cat.12	3.310,00
Cat.13	3.573,00

07 S74 N/E D. ORANGE 03.2023

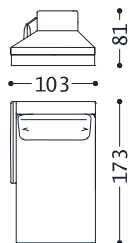

1SPADORMSX

DORMEUSE ARMLEHNE LINKS
DORMEUSE ARMLEHNE RECHTS

1SPADORMSX

1SPADORMDX

Cat.3	1.716,00
Cat.4	1.813,00
Cat.5	1.885,00
Cat.6	1.958,00
Cat.7	2.054,00
Cat.8	2.151,00
Cat.9	2.441,00
Cat.10	2.634,00
Cat.11	2.851,00
Cat.12	3.068,00
Cat.13	3.334,00

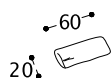

1SPACPP

LOSE RÜCKENKISSEN AUS FEDER

1SPACPP

Cat.3	73,00
Cat.4	83,00
Cat.5	91,00
Cat.6	99,00
Cat.7	110,00
Cat.8	121,00
Cat.9	153,00
Cat.10	174,00
Cat.11	198,00
Cat.12	222,00
Cat.13	251,00

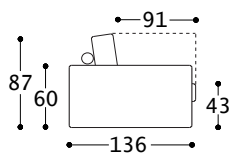
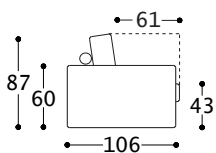

07 S74 N/E D. ORANGE 03.2023

DIE STOFF-VERSION IST ABNEHMBAR UND MAN KANN SITZ, CHASSIS UND RÜCKENKISSEN MIT UNTERSCHIEDLICHEN STOFFEN BEZIEHEN. GESTREIFTE STOFFE ODER STOFFE MIT MUSTERN EIGNEN SICH NUR FÜR RÜCKENKISSEN UND SITZ. ACHTUNG: ZYLINDER UND RÜCKENKISSEN KÖNNEN NUR MIT DEM SELBEN STOFF BEZOGEN WERDEN. LIEFERBAR AUCH AUS KUNSTLEDER (NICHT ABNEHMBAR). ELEMENTE MIT TIEFE 136 CM WERDEN IMMER MIT EINEM LOSEN RÜCKENKISSEN UND DEMONTIERBAREN ARMLEHNEN MIT BAJONETTBSCHLAG GELIEFERT. BEIM ECKELEMENTE SIND ZWEI TIEFEN MÖGLICH, 106 UND 136 CM. DIE STANDARDTIEFE 106 BESTIMMT DIE SEITE RECHTS ODER LINKS FÜR DIE ARTIKELBEZEICHNUNG. STAHLFEDERN TYP "NOSAG".

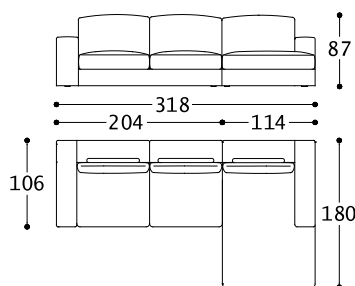

C7STSMM

1 MAXI DORMEUSE ARMLEHNE RECHTS
1 ZWEI SITZER MAXI SOFA ARMLEHNE LINKS

C7STSMM		OSMRC7	
Cat.3	4.800,00	Cat.E	6.983,00
Cat.4	5.079,00	Cat.F	8.641,00
Cat.5	5.288,00	Cat.G	9.312,00
Cat.6	5.497,00	Cat.H	10.504,00
Cat.7	5.776,00	Cat.I	11.817,00
Cat.8	6.055,00	Cat.L	12.721,00
Cat.9	6.891,00	Cat.M	13.881,00
Cat.10	7.448,00		
Cat.11	8.075,00		
Cat.12	8.702,00		
Cat.13	9.468,00		

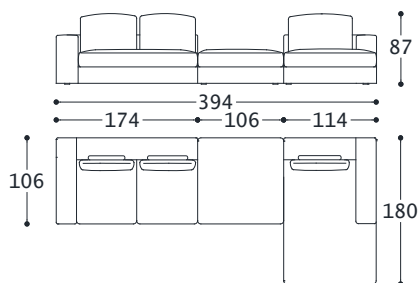

C3STSMM

1 MAXI DORMEUSE ARMLEHNE RECHTS
1 ZWEI SITZER SOFA ARMLEHNE LINKS
1 QUADRATISCHER HOCKER

C3STSMM		OSMRC3	
Cat.3	5.556,00	Cat.E	8.133,00
Cat.4	5.886,00	Cat.F	9.943,00
Cat.5	6.133,00	Cat.G	10.672,00
Cat.6	6.382,00	Cat.H	11.979,00
Cat.7	6.713,00	Cat.I	13.380,00
Cat.8	7.043,00	Cat.L	14.367,00
Cat.9	8.035,00	Cat.M	15.636,00
Cat.10	8.696,00		
Cat.11	9.439,00		
Cat.12	10.183,00		
Cat.13	11.091,00		

07 S74 N/E D. ORANGE 03.2023

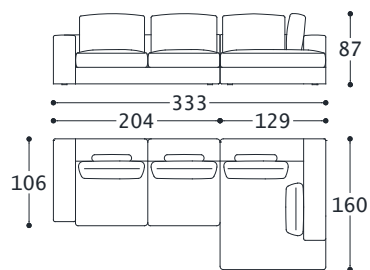

OSMMC17

1 DORMEUSE JOLLY ARMLEHNE RECHTS
1 ZWEI SITZER MAXI SOFA ARMLEHNE
LINKS

OSMMC17		OSMRC17	
Cat.3	4.783,00	Cat.E	6.960,00
Cat.4	5.076,00	Cat.F	8.625,00
Cat.5	5.295,00	Cat.G	9.300,00
Cat.6	5.514,00	Cat.H	10.496,00
Cat.7	5.805,00	Cat.I	11.818,00
Cat.8	6.098,00	Cat.L	12.725,00
Cat.9	6.974,00	Cat.M	13.891,00
Cat.10	7.558,00		
Cat.11	8.215,00		
Cat.12	8.872,00		
Cat.13	9.675,00		

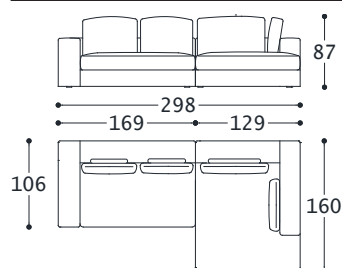

C1STSMM

1 DORMEUSE JOLLY ARMLEHNE RECHTS
1 ZWEI SITZER LARGE JOLLY SOFA
ARMLEHNE LINKS

C1STSMM		OSMRC1	
Cat.3	4.409,00	Cat.E	6.473,00
Cat.4	4.680,00	Cat.F	7.947,00
Cat.5	4.884,00	Cat.G	8.542,00
Cat.6	5.087,00	Cat.H	9.604,00
Cat.7	5.358,00	Cat.I	10.755,00
Cat.8	5.629,00	Cat.L	11.557,00
Cat.9	6.442,00	Cat.M	12.591,00
Cat.10	6.985,00		
Cat.11	7.596,00		
Cat.12	8.206,00		
Cat.13	8.951,00		

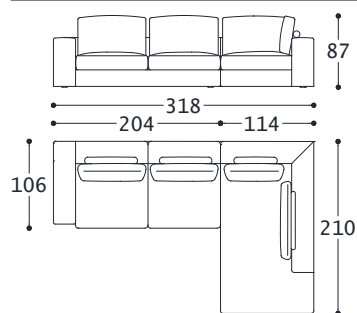

OSMMC18

1 ZWEI SITZER MAXI SOFA ARMLEHNE
LINKS
1 MERIDIENNE RECHTS

OSMMC18		OSMRC18	
Cat.3	5.068,00	Cat.E	7.565,00
Cat.4	5.379,00	Cat.F	9.362,00
Cat.5	5.612,00	Cat.G	10.089,00
Cat.6	5.846,00	Cat.H	11.382,00
Cat.7	6.156,00	Cat.I	12.805,00
Cat.8	6.468,00	Cat.L	13.784,00
Cat.9	7.401,00	Cat.M	15.042,00
Cat.10	8.023,00		
Cat.11	8.722,00		
Cat.12	9.422,00		
Cat.13	10.278,00		

07 S74 N/E D. ORANGE 03.2023

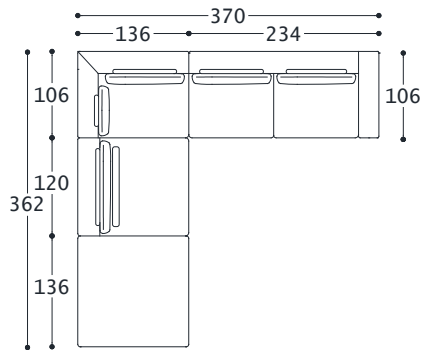

OSMMC12

1 ECKELEMENT RECHTS TIEF
 1 DREI SITZER SOFA ARMLEHNE RECHTS
 1 QUADRATISCHER HOCKER TIEF
 1 ZENTRAL LARGE Sessel TIEF (1 LOSER NIERENKISSEN INKLUSIVE)

OSMMC12		OSMRC12	
Cat.3	7.984,00	Cat.E	12.328,00
Cat.4	8.456,00	Cat.F	15.245,00
Cat.5	8.811,00	Cat.G	16.427,00
Cat.6	9.167,00	Cat.H	18.527,00
Cat.7	9.639,00	Cat.I	20.836,00
Cat.8	10.113,00	Cat.L	22.424,00
Cat.9	11.531,00	Cat.M	24.470,00
Cat.10	12.477,00		
Cat.11	13.543,00		
Cat.12	14.606,00		
Cat.13	15.906,00		

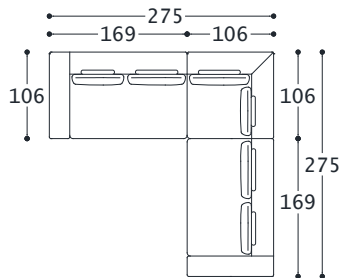

C8STSMM

1 ECKELEMENT
 1 ZWEI SITZER LARGE JOLLY SOFA ARMLEHNE RECHTS
 1 ZWEI SITZER LARGE JOLLY SOFA ARMLEHNE LINKS

C8STSMM		OSMRC8	
Cat.3	5.772,00	Cat.E	9.044,00
Cat.4	6.150,00	Cat.F	11.139,00
Cat.5	6.436,00	Cat.G	11.985,00
Cat.6	6.720,00	Cat.H	13.495,00
Cat.7	7.100,00	Cat.I	15.142,00
Cat.8	7.479,00	Cat.L	16.282,00
Cat.9	8.616,00	Cat.M	17.752,00
Cat.10	9.375,00		
Cat.11	10.231,00		
Cat.12	11.085,00		
Cat.13	12.127,00		

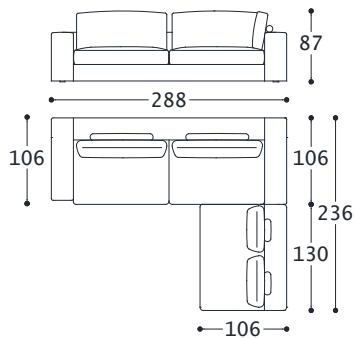

OSMMC19

1 DREI SITZER MAXI SOFA
 1 ZENTRAL Sessel JOLLY

VORSCHLAG: ein Zusatz Jolly-Rückenkissen mit Zylinder (Code 1SMMCJ) in der Kombination an der Armlehne des Sofas

OSMMC19		OSMRC19	
Cat.3	4.812,00	Cat.E	7.332,00
Cat.4	5.116,00	Cat.F	9.146,00
Cat.5	5.346,00	Cat.G	9.883,00
Cat.6	5.574,00	Cat.H	11.185,00
Cat.7	5.880,00	Cat.I	12.642,00
Cat.8	6.185,00	Cat.L	13.631,00
Cat.9	7.101,00	Cat.M	14.902,00
Cat.10	7.712,00		
Cat.11	8.398,00		
Cat.12	9.086,00		
Cat.13	9.925,00		

07 S74 N/E D. ORANGE 03.2023

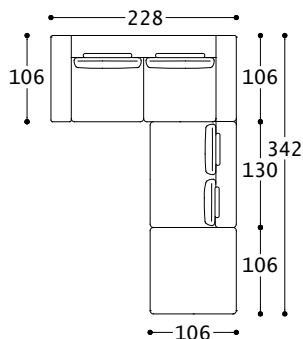

C5STSMM

1 ZWEI SITZER MAXI SOFA
1 QUADRATISCHER HOCKER
1 ZENTRAL SESSEL JOLLY

VORSCHLAG: ein Zusatz Jolly-Rückenkissen mit Zylinder (Code 1SMMCJ) in der Kombination an der Armlehne des Sofas

C5STSMM	
Cat.3	5.338,00
Cat.4	5.673,00
Cat.5	5.926,00
Cat.6	6.178,00
Cat.7	6.514,00
Cat.8	6.851,00
Cat.9	7.860,00
Cat.10	8.532,00
Cat.11	9.288,00
Cat.12	10.045,00
Cat.13	10.969,00

0SMRC5	
Cat.E	7.904,00
Cat.F	9.777,00
Cat.G	10.535,00
Cat.H	11.884,00
Cat.I	13.365,00
Cat.L	14.387,00
Cat.M	15.700,00

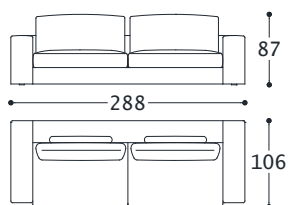

D3MSTSMM

DREI SITZER MAXI SOFA

D3MSTSMM	
Cat.3	3.161,00
Cat.4	3.357,00
Cat.5	3.505,00
Cat.6	3.652,00
Cat.7	3.849,00
Cat.8	4.045,00
Cat.9	4.635,00
Cat.10	5.028,00
Cat.11	5.470,00
Cat.12	5.913,00
Cat.13	6.453,00

2SMRD3M	
Cat.E	4.845,00
Cat.F	6.085,00
Cat.G	6.591,00
Cat.H	7.479,00
Cat.I	8.487,00
Cat.L	9.163,00
Cat.M	10.032,00

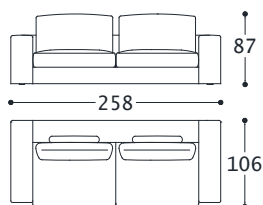

D3STSMM

DREI SITZER SOFA

D3STSMM	
Cat.3	2.865,00
Cat.4	3.047,00
Cat.5	3.184,00
Cat.6	3.321,00
Cat.7	3.503,00
Cat.8	3.685,00
Cat.9	4.231,00
Cat.10	4.596,00
Cat.11	5.006,00
Cat.12	5.415,00
Cat.13	5.916,00

2SMRD3	
Cat.E	4.379,00
Cat.F	5.482,00
Cat.G	5.932,00
Cat.H	6.723,00
Cat.I	7.615,00
Cat.L	8.216,00
Cat.M	8.989,00

07 S74 N/E D. ORANGE 03.2023

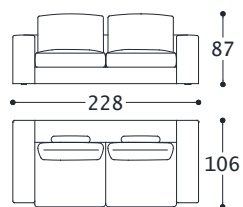

D2MSTSMM

ZWEI SITZER MAXI SOFA

D2MSTSMM		2SMRD2M	
Cat.3	2.650,00	Cat.E	3.922,00
Cat.4	2.820,00	Cat.F	4.925,00
Cat.5	2.948,00	Cat.G	5.334,00
Cat.6	3.075,00	Cat.H	6.053,00
Cat.7	3.245,00	Cat.I	6.867,00
Cat.8	3.415,00	Cat.L	7.414,00
Cat.9	3.925,00	Cat.M	8.117,00
Cat.10	4.264,00		
Cat.11	4.647,00		
Cat.12	5.029,00		
Cat.13	5.496,00		

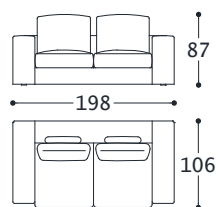

D2STSMM

ZWEI SITZER SOFA

D2STSMM		2SMRD2	
Cat.3	2.299,00	Cat.E	3.517,00
Cat.4	2.463,00	Cat.F	4.377,00
Cat.5	2.586,00	Cat.G	4.726,00
Cat.6	2.709,00	Cat.H	5.343,00
Cat.7	2.873,00	Cat.I	6.031,00
Cat.8	3.037,00	Cat.L	6.499,00
Cat.9	3.530,00	Cat.M	7.102,00
Cat.10	3.858,00		
Cat.11	4.228,00		
Cat.12	4.597,00		
Cat.13	5.048,00		

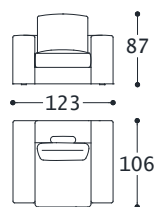

PSTSMM

SESSEL

PSTSMM		2SMRP	
Cat.3	1.425,00	Cat.E	2.355,00
Cat.4	1.530,00	Cat.F	2.920,00
Cat.5	1.609,00	Cat.G	3.149,00
Cat.6	1.688,00	Cat.H	3.556,00
Cat.7	1.793,00	Cat.I	4.006,00
Cat.8	1.898,00	Cat.L	4.314,00
Cat.9	2.213,00	Cat.M	4.710,00
Cat.10	2.423,00		
Cat.11	2.660,00		
Cat.12	2.896,00		
Cat.13	3.186,00		

07 S74 N/E D. ORANGE 03.2023

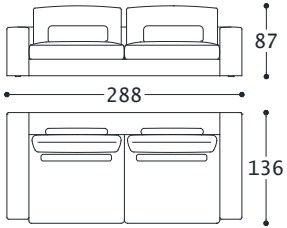

1SMMD3MPR

DREI SITZER MAXI SOFA TIEF (2 LOSE NIERENKISSEN INKLUSIVE)

1SMMD3MPR		2SMRD3MPR	
Cat.3	4.032,00	Cat.E	6.001,00
Cat.4	4.255,00	Cat.F	7.496,00
Cat.5	4.423,00	Cat.G	8.104,00
Cat.6	4.590,00	Cat.H	9.178,00
Cat.7	4.813,00	Cat.I	10.382,00
Cat.8	5.036,00	Cat.L	11.197,00
Cat.9	5.706,00	Cat.M	12.245,00
Cat.10	6.152,00		
Cat.11	6.655,00		
Cat.12	7.157,00		
Cat.13	7.771,00		

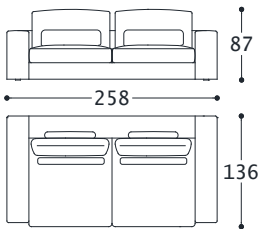

1SMMD3PR

DREI SITZER SOFA TIEF (2 LOSE NIERENKISSEN INKLUSIVE)

1SMMD3PR		2SMRD3PR	
Cat.3	3.653,00	Cat.E	5.436,00
Cat.4	3.865,00	Cat.F	6.790,00
Cat.5	4.024,00	Cat.G	7.341,00
Cat.6	4.184,00	Cat.H	8.313,00
Cat.7	4.396,00	Cat.I	9.403,00
Cat.8	4.609,00	Cat.L	10.141,00
Cat.9	5.246,00	Cat.M	11.090,00
Cat.10	5.671,00		
Cat.11	6.148,00		
Cat.12	6.626,00		
Cat.13	7.210,00		

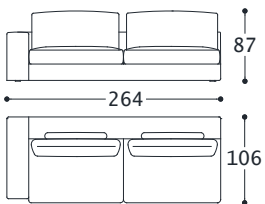

D3MSXSTSMM

DREI SITZER MAXI SOFA ARMLEHNE LINKS
DREI SITZER MAXI SOFA ARMLEHNE
RECHTS

D3MSXSTSMM		2SMRD3MSX	
D3MDXSTSMM		2SMRD3MDX	
Cat.3	3.016,00	Cat.E	4.589,00
Cat.4	3.196,00	Cat.F	5.733,00
Cat.5	3.331,00	Cat.G	6.199,00
Cat.6	3.466,00	Cat.H	7.020,00
Cat.7	3.646,00	Cat.I	7.942,00
Cat.8	3.826,00	Cat.L	8.566,00
Cat.9	4.366,00	Cat.M	9.368,00
Cat.10	4.726,00		
Cat.11	5.131,00		
Cat.12	5.536,00		
Cat.13	6.031,00		

07 S74 N/E D. ORANGE 03.2023

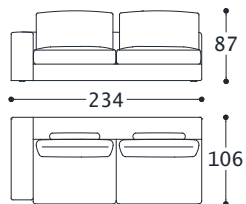

D3SXSTSM

DREI SITZER SOFA ARMLEHNE LINKS
DREI SITZER SOFA ARMLEHNE RECHTS

D3SXSTSM		2SMRD3SX	
D3DXSTSM		2SMRD3DX	
Cat.3	2.693,00	Cat.E	4.075,00
Cat.4	2.866,00	Cat.F	5.083,00
Cat.5	2.997,00	Cat.G	5.493,00
Cat.6	3.127,00	Cat.H	6.217,00
Cat.7	3.300,00	Cat.I	7.027,00
Cat.8	3.474,00	Cat.L	7.576,00
Cat.9	3.994,00	Cat.M	8.283,00
Cat.10	4.341,00		
Cat.11	4.732,00		
Cat.12	5.122,00		
Cat.13	5.599,00		

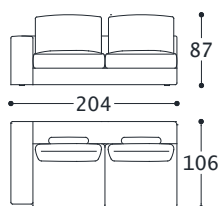

D2MSXSTSM

ZWEI SITZER MAXI SOFA ARMLEHNE LINKS
ZWEI SITZER MAXI SOFA ARMLEHNE
RECHTS

D2MSXSTSM		2SMRD2MSX	
D2MDXSTSM		2SMRD2MDX	
Cat.3	2.473,00	Cat.E	3.633,00
Cat.4	2.627,00	Cat.F	4.541,00
Cat.5	2.742,00	Cat.G	4.910,00
Cat.6	2.857,00	Cat.H	5.561,00
Cat.7	3.010,00	Cat.I	6.292,00
Cat.8	3.164,00	Cat.L	6.787,00
Cat.9	3.624,00	Cat.M	7.422,00
Cat.10	3.930,00		
Cat.11	4.275,00		
Cat.12	4.620,00		
Cat.13	5.042,00		

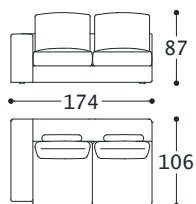

D2SXSTSM

ZWEI SITZER SOFA ARMLEHNE LINKS
ZWEI SITZER SOFA ARMLEHNE RECHTS

D2SXSTSM		2SMRD2SX	
D2DXSTSM		2SMRD2DX	
Cat.3	2.192,00	Cat.E	3.288,00
Cat.4	2.340,00	Cat.F	4.052,00
Cat.5	2.450,00	Cat.G	4.361,00
Cat.6	2.561,00	Cat.H	4.911,00
Cat.7	2.709,00	Cat.I	5.512,00
Cat.8	2.856,00	Cat.L	5.928,00
Cat.9	3.299,00	Cat.M	6.464,00
Cat.10	3.594,00		
Cat.11	3.926,00		
Cat.12	4.258,00		
Cat.13	4.664,00		

07 S74 N/E D. ORANGE 03.2023

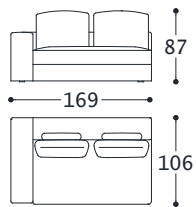

D2LSXSTSM

ZWEI SITZER LARGE JOLLY SOFA
ARMLEHNE LINKS
ZWEI SITZER LARGE JOLLY SOFA
ARMLEHNE RECHTS

D2LSXSTSM		2SMRD2LJSX	
D2LDXSTSM		2SMRD2LJDX	
Cat.3	2.099,00	Cat.E	3.146,00
Cat.4	2.231,00	Cat.F	3.863,00
Cat.5	2.331,00	Cat.G	4.152,00
Cat.6	2.430,00	Cat.H	4.669,00
Cat.7	2.563,00	Cat.I	5.229,00
Cat.8	2.695,00	Cat.L	5.619,00
Cat.9	3.092,00	Cat.M	6.122,00
Cat.10	3.357,00		
Cat.11	3.656,00		
Cat.12	3.954,00		
Cat.13	4.318,00		

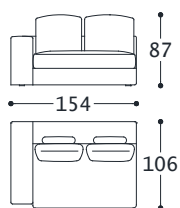

1SMPLSX

SESSEL LARGE ARMLEHNE LINKS
SESSEL LARGE ARMLEHNE RECHTS

KANN AM RÜCKEN BEFESTIGT WERDEN

1SMPLSX		2SMRPLSX	
1SMPLDX		2SMRPLDX	
Cat.3	1.771,00	Cat.E	2.760,00
Cat.4	1.895,00	Cat.F	3.429,00
Cat.5	1.989,00	Cat.G	3.701,00
Cat.6	2.082,00	Cat.H	4.182,00
Cat.7	2.207,00	Cat.I	4.716,00
Cat.8	2.331,00	Cat.L	5.081,00
Cat.9	2.705,00	Cat.M	5.550,00
Cat.10	2.954,00		
Cat.11	3.234,00		
Cat.12	3.514,00		
Cat.13	3.857,00		

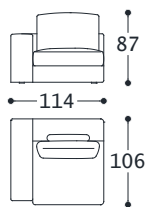

PMSXSTSM

SESSEL MAXI ARMLEHNE LINKS
SESSEL MAXI ARMLEHNE RECHTS

PMSXSTSM		2SMRPMSX	
PMDXSTSM		2SMRPMDX	
Cat.3	1.356,00	Cat.E	2.343,00
Cat.4	1.456,00	Cat.F	2.858,00
Cat.5	1.531,00	Cat.G	3.065,00
Cat.6	1.607,00	Cat.H	3.437,00
Cat.7	1.707,00	Cat.I	3.834,00
Cat.8	1.807,00	Cat.L	4.115,00
Cat.9	2.107,00	Cat.M	4.476,00
Cat.10	2.307,00		
Cat.11	2.532,00		
Cat.12	2.757,00		
Cat.13	3.033,00		

07 S74 N/E D. ORANGE 03.2023

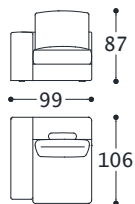

PSXSTSMM

SESSEL ARMLEHNE LINKS
SESSEL ARMLEHNE RECHTS

PSXSTSMM		2SMRPSX	
PDXSTSMM		2SMRPDX	
Cat.3	1.266,00	Cat.E	2.092,00
Cat.4	1.354,00	Cat.F	2.562,00
Cat.5	1.421,00	Cat.G	2.751,00
Cat.6	1.487,00	Cat.H	3.090,00
Cat.7	1.576,00	Cat.I	3.454,00
Cat.8	1.664,00	Cat.L	3.710,00
Cat.9	1.930,00	Cat.M	4.039,00
Cat.10	2.107,00		
Cat.11	2.306,00		
Cat.12	2.506,00		
Cat.13	2.749,00		

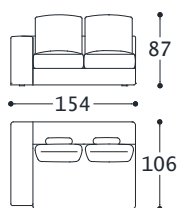

PSXJSTSMM

SESSEL JOLLY ARMLEHNE LINKS
SESSEL JOLLY ARMLEHNE RECHTS

KANN AN DER ARMLEHNE BEFESTIGT WERDEN

PSXJSTSMM		2SMRPJSX	
PDXJSTSMM		2SMRPJDX	
Cat.3	1.787,00	Cat.E	2.782,00
Cat.4	1.903,00	Cat.F	3.451,00
Cat.5	1.990,00	Cat.G	3.723,00
Cat.6	2.077,00	Cat.H	4.204,00
Cat.7	2.193,00	Cat.I	4.737,00
Cat.8	2.309,00	Cat.L	5.101,00
Cat.9	2.657,00	Cat.M	5.570,00
Cat.10	2.889,00		
Cat.11	3.149,00		
Cat.12	3.410,00		
Cat.13	3.729,00		

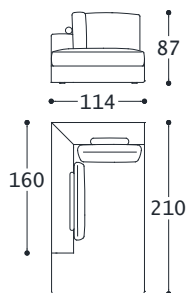

MERSXSMM

MERIDIENNE LINKS
MERIDIENNE RECHTS

MERSXSMM		2SMRMERSX	
MERDXSMM		2SMRMERDX	
Cat.3	2.595,00	Cat.E	3.932,00
Cat.4	2.752,00	Cat.F	4.821,00
Cat.5	2.870,00	Cat.G	5.179,00
Cat.6	2.989,00	Cat.H	5.821,00
Cat.7	3.146,00	Cat.I	6.513,00
Cat.8	3.304,00	Cat.L	6.997,00
Cat.9	3.777,00	Cat.M	7.620,00
Cat.10	4.093,00		
Cat.11	4.447,00		
Cat.12	4.802,00		
Cat.13	5.236,00		

07 S74 N/E D. ORANGE 03.2023

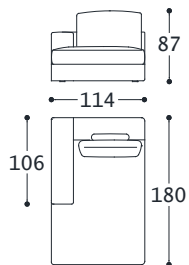

DORMXSXSMM

MAXI DORMEUSE ARMLEHNE LINKS
MAXI DORMEUSE ARMLEHNE RECHTS

DORMXSXSMM		2SMRDORMXSX	
DORMXDXSMM		2SMRDORMXDX	
Cat.3	2.327,00	Cat.E	3.350,00
Cat.4	2.452,00	Cat.F	4.100,00
Cat.5	2.546,00	Cat.G	4.402,00
Cat.6	2.640,00	Cat.H	4.943,00
Cat.7	2.766,00	Cat.I	5.525,00
Cat.8	2.891,00	Cat.L	5.934,00
Cat.9	3.267,00	Cat.M	6.459,00
Cat.10	3.518,00		
Cat.11	3.800,00		
Cat.12	4.082,00		
Cat.13	4.426,00		

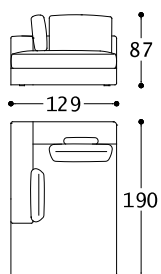

1SMMDORJLSX

LANG DORMEUSE JOLLY ARMLEHNE
LINKS
LANG DORMEUSE JOLLY ARMLEHNE
RECHTS

1SMMDORJLSX		2SMRDORJLSX	
1SMMDORJLDX		2SMRDORJLDX	
Cat.3	2.572,00	Cat.E	3.673,00
Cat.4	2.716,00	Cat.F	4.491,00
Cat.5	2.823,00	Cat.G	4.820,00
Cat.6	2.931,00	Cat.H	5.411,00
Cat.7	3.074,00	Cat.I	6.045,00
Cat.8	3.217,00	Cat.L	6.491,00
Cat.9	3.647,00	Cat.M	7.065,00
Cat.10	3.934,00		
Cat.11	4.256,00		
Cat.12	4.578,00		
Cat.13	4.972,00		

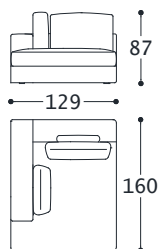

DORMSXSM

DORMEUSE JOLLY ARMLEHNE LINKS
DORMEUSE JOLLY ARMLEHNE RECHTS

DORMSXSM		2SMRDORJSX	
DORMDXSM		2SMRDORJDX	
Cat.3	2.310,00	Cat.E	3.327,00
Cat.4	2.449,00	Cat.F	4.084,00
Cat.5	2.553,00	Cat.G	4.390,00
Cat.6	2.657,00	Cat.H	4.935,00
Cat.7	2.795,00	Cat.I	5.526,00
Cat.8	2.934,00	Cat.L	5.938,00
Cat.9	3.350,00	Cat.M	6.469,00
Cat.10	3.628,00		
Cat.11	3.940,00		
Cat.12	4.252,00		
Cat.13	4.633,00		

07 S74 N/E D. ORANGE 03.2023

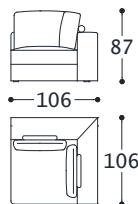

ARSTSMM

ECKELEMENT

ARSTSMM		2SMRAR	
Cat.3	1.574,00	Cat.E	2.752,00
Cat.4	1.688,00	Cat.F	3.413,00
Cat.5	1.774,00	Cat.G	3.681,00
Cat.6	1.860,00	Cat.H	4.157,00
Cat.7	1.974,00	Cat.I	4.684,00
Cat.8	2.089,00	Cat.L	5.044,00
Cat.9	2.432,00	Cat.M	5.508,00
Cat.10	2.661,00		
Cat.11	2.919,00		
Cat.12	3.177,00		
Cat.13	3.491,00		

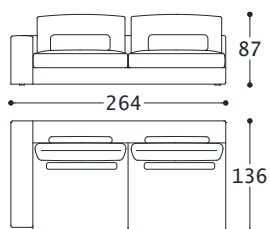

1SMMD3MPRSX

DREI SITZER MAXI SOFA ARMLEHNE LINKS TIEF (2 LOSE NIERENKISSEN INKLUSIVE)
DREI SITZER MAXI SOFA ARMLEHNE RECHTS TIEF (2 LOSE NIERENKISSEN INKLUSIVE)

1SMMD3MPRSX		2SMRD3MPRSX	
1SMMD3MPRDX		2SMRD3MPRDX	
Cat.3	3.783,00	Cat.E	5.607,00
Cat.4	3.993,00	Cat.F	6.979,00
Cat.5	4.151,00	Cat.G	7.536,00
Cat.6	4.309,00	Cat.H	8.522,00
Cat.7	4.519,00	Cat.I	9.621,00
Cat.8	4.729,00	Cat.L	10.369,00
Cat.9	5.360,00	Cat.M	11.331,00
Cat.10	5.780,00		
Cat.11	6.253,00		
Cat.12	6.726,00		
Cat.13	7.304,00		

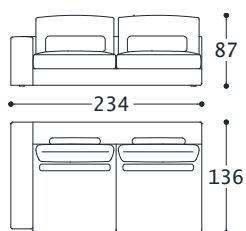

1SMMD3PRSX

DREI SITZER SOFA ARMLEHNE LINKS TIEF (2 LOSE NIERENKISSEN INKLUSIVE)
DREI SITZER SOFA ARMLEHNE RECHTS TIEF (2 LOSE NIERENKISSEN INKLUSIVE)

1SMMD3PRSX		2SMRD3PRSX	
1SMMD3PRDX		2SMRD3PRDX	
Cat.3	3.396,00	Cat.E	5.016,00
Cat.4	3.592,00	Cat.F	6.247,00
Cat.5	3.739,00	Cat.G	6.748,00
Cat.6	3.886,00	Cat.H	7.632,00
Cat.7	4.082,00	Cat.I	8.618,00
Cat.8	4.278,00	Cat.L	9.289,00
Cat.9	4.865,00	Cat.M	10.152,00
Cat.10	5.257,00		
Cat.11	5.698,00		
Cat.12	6.138,00		
Cat.13	6.677,00		

07 S74 N/E D. ORANGE 03.2023

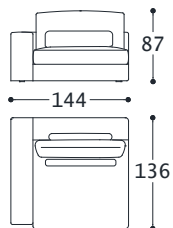

1SMMPLPRSX

LARGE SESSEL ARMLEHNE LINKS TIEF (1
LOSER NIERENKISSEN INKLUSIVE)
LARGE SESSEL ARMLEHNE RECHTS TIEF (1
LOSER NIERENKISSEN INKLUSIVE)

1SMMPLPRSX		2SMRPLPRSX	
1SMMPLPRDX		2SMRPLPRDX	
Cat.3	2.177,00	Cat.E	3.298,00
Cat.4	2.307,00	Cat.F	3.997,00
Cat.5	2.405,00	Cat.G	4.276,00
Cat.6	2.503,00	Cat.H	4.783,00
Cat.7	2.633,00	Cat.I	5.313,00
Cat.8	2.763,00	Cat.L	5.694,00
Cat.9	3.154,00	Cat.M	6.184,00
Cat.10	3.415,00		
Cat.11	3.708,00		
Cat.12	4.001,00		
Cat.13	4.360,00		

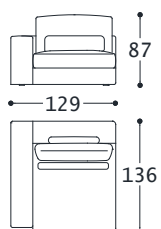

1SMMPMDPRSX

MEDIEN SESSEL ARMLEHNE LINKS TIEF (1
LOSER NIERENKISSEN INKLUSIVE)
MEDIEN SESSEL ARMLEHNE RECHTS TIEF (1
LOSER NIERENKISSEN INKLUSIVE)

1SMMPMDPRSX		2SMRPMDPRSX	
1SMMPMDPRDX		2SMRPMDPRDX	
Cat.3	1.946,00	Cat.E	3.048,00
Cat.4	2.073,00	Cat.F	3.755,00
Cat.5	2.168,00	Cat.G	4.040,00
Cat.6	2.263,00	Cat.H	4.549,00
Cat.7	2.390,00	Cat.I	5.105,00
Cat.8	2.517,00	Cat.L	5.490,00
Cat.9	2.897,00	Cat.M	5.985,00
Cat.10	3.150,00		
Cat.11	3.435,00		
Cat.12	3.720,00		
Cat.13	4.069,00		

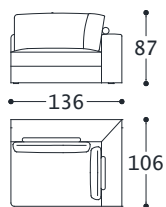

1SMMARPRSX

ECKELEMENT LINKS TIEF
ECKELEMENT RECHTS TIEF

1SMMARPRSX		2SMRARPRSX	
1SMMARPRDX		2SMRARPRDX	
Cat.3	1.882,00	Cat.E	3.207,00
Cat.4	2.002,00	Cat.F	4.054,00
Cat.5	2.092,00	Cat.G	4.401,00
Cat.6	2.183,00	Cat.H	5.007,00
Cat.7	2.303,00	Cat.I	5.702,00
Cat.8	2.423,00	Cat.L	6.163,00
Cat.9	2.784,00	Cat.M	6.757,00
Cat.10	3.024,00		
Cat.11	3.295,00		
Cat.12	3.565,00		
Cat.13	3.896,00		

07 S74 N/E D. ORANGE 03.2023

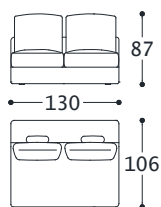

1SM MPL1

ZENTRAL LARGE SESSEL

KANN AM RÜCKEN BEFESTIGT WERDEN

1SM MPL1		2SMR PL1	
Cat.3	1.617,00	Cat.E	2.456,00
Cat.4	1.725,00	Cat.F	3.029,00
Cat.5	1.807,00	Cat.G	3.261,00
Cat.6	1.888,00	Cat.H	3.674,00
Cat.7	1.997,00	Cat.I	4.126,00
Cat.8	2.106,00	Cat.L	4.439,00
Cat.9	2.432,00	Cat.M	4.841,00
Cat.10	2.649,00		
Cat.11	2.894,00		
Cat.12	3.139,00		
Cat.13	3.438,00		

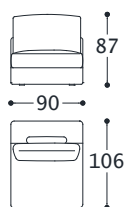

P1M STSMM

ZENTRAL MAXI SESSEL

P1M STSMM		2SMR PM1	
Cat.3	1.193,00	Cat.E	1.949,00
Cat.4	1.282,00	Cat.F	2.369,00
Cat.5	1.348,00	Cat.G	2.537,00
Cat.6	1.415,00	Cat.H	2.840,00
Cat.7	1.503,00	Cat.I	3.161,00
Cat.8	1.592,00	Cat.L	3.389,00
Cat.9	1.858,00	Cat.M	3.683,00
Cat.10	2.035,00		
Cat.11	2.234,00		
Cat.12	2.433,00		
Cat.13	2.677,00		

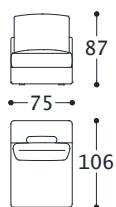

P1 STSMM

ZENTRAL SESSEL

P1 STSMM		2SMR P1	
Cat.3	1.097,00	Cat.E	1.792,00
Cat.4	1.178,00	Cat.F	2.166,00
Cat.5	1.239,00	Cat.G	2.315,00
Cat.6	1.300,00	Cat.H	2.586,00
Cat.7	1.381,00	Cat.I	2.868,00
Cat.8	1.463,00	Cat.L	3.072,00
Cat.9	1.707,00	Cat.M	3.334,00
Cat.10	1.870,00		
Cat.11	2.053,00		
Cat.12	2.236,00		
Cat.13	2.459,00		

07 S74 N/E D. ORANGE 03.2023

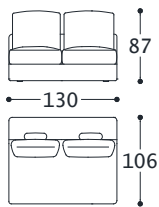

PCENJSTSMM

ZENTRAL SESSEL JOLLY

KANN AN DER ARMLEHNE BEFESTIGT WERDEN

PCENJSTSMM		2SMRPJ1	
Cat.3	1.651,00	Cat.E	2.487,00
Cat.4	1.759,00	Cat.F	3.061,00
Cat.5	1.841,00	Cat.G	3.292,00
Cat.6	1.922,00	Cat.H	3.706,00
Cat.7	2.031,00	Cat.I	4.155,00
Cat.8	2.140,00	Cat.L	4.468,00
Cat.9	2.466,00	Cat.M	4.870,00
Cat.10	2.684,00		
Cat.11	2.928,00		
Cat.12	3.173,00		
Cat.13	3.472,00		

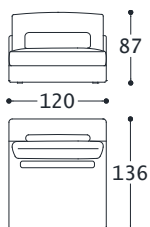

1SMMPLPR1

ZENTRAL LARGE SESSEL TIEF (1 LOSER NIERENKISSEN INKLUSIVE)

1SMMPLPR1		2SMRPLPR1	
Cat.3	1.942,00	Cat.E	2.988,00
Cat.4	2.059,00	Cat.F	3.663,00
Cat.5	2.147,00	Cat.G	3.935,00
Cat.6	2.235,00	Cat.H	4.422,00
Cat.7	2.352,00	Cat.I	4.947,00
Cat.8	2.470,00	Cat.L	5.314,00
Cat.9	2.822,00	Cat.M	5.787,00
Cat.10	3.057,00		
Cat.11	3.321,00		
Cat.12	3.585,00		
Cat.13	3.907,00		

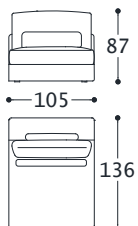

1SMMPMDPR1

ZENTRAL MEDIEN SESSEL TIEF (1 LOSER NIERENKISSEN INKLUSIVE)

1SMMPMDPR1		2SMRPMDPR1	
Cat.3	1.711,00	Cat.E	2.648,00
Cat.4	1.825,00	Cat.F	3.245,00
Cat.5	1.910,00	Cat.G	3.486,00
Cat.6	1.995,00	Cat.H	3.917,00
Cat.7	2.109,00	Cat.I	4.382,00
Cat.8	2.223,00	Cat.L	4.707,00
Cat.9	2.564,00	Cat.M	5.126,00
Cat.10	2.792,00		
Cat.11	3.048,00		
Cat.12	3.304,00		
Cat.13	3.616,00		

07 S74 N/E D. ORANGE 03.2023

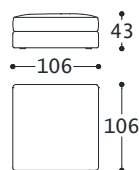

POUFFQSMM

QUADRATISCHER HOCKER

POUFFQSMM		2SMRPFQ	
Cat.3	1.037,00	Cat.E	1.495,00
Cat.4	1.094,00	Cat.F	1.791,00
Cat.5	1.137,00	Cat.G	1.909,00
Cat.6	1.181,00	Cat.H	2.125,00
Cat.7	1.238,00	Cat.I	2.343,00
Cat.8	1.296,00	Cat.L	2.505,00
Cat.9	1.469,00	Cat.M	2.713,00
Cat.10	1.584,00		
Cat.11	1.713,00		
Cat.12	1.843,00		
Cat.13	2.001,00		

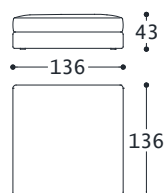

1SMMPFQPR

QUADRATISCHER HOCKER TIEF

1SMMPFQPR		2SMRPFQPR	
Cat.3	1.467,00	Cat.E	2.058,00
Cat.4	1.529,00	Cat.F	2.445,00
Cat.5	1.575,00	Cat.G	2.598,00
Cat.6	1.622,00	Cat.H	2.881,00
Cat.7	1.684,00	Cat.I	3.160,00
Cat.8	1.746,00	Cat.L	3.371,00
Cat.9	1.931,00	Cat.M	3.643,00
Cat.10	2.055,00		
Cat.11	2.195,00		
Cat.12	2.334,00		
Cat.13	2.504,00		

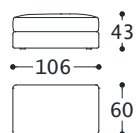

1SMMPFFR

RECHTECKIGER HOCKER

1SMMPFFR		2SMRPFRR	
Cat.3	937,00	Cat.E	1.452,00
Cat.4	995,00	Cat.F	1.748,00
Cat.5	1.038,00	Cat.G	1.866,00
Cat.6	1.081,00	Cat.H	2.081,00
Cat.7	1.139,00	Cat.I	2.303,00
Cat.8	1.196,00	Cat.L	2.464,00
Cat.9	1.369,00	Cat.M	2.672,00
Cat.10	1.484,00		
Cat.11	1.614,00		
Cat.12	1.744,00		
Cat.13	1.902,00		

07 S74 N/E D. ORANGE 03.2023

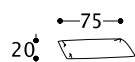

1SM MCP75

NIERENKISSEN 75 CM

1SM MCP75		2SM RCP75	
Cat.3	96,00	Cat.E	148,00
Cat.4	112,00	Cat.F	208,00
Cat.5	124,00	Cat.G	232,00
Cat.6	136,00	Cat.H	274,00
Cat.7	151,00	Cat.I	328,00
Cat.8	167,00	Cat.L	360,00
Cat.9	215,00	Cat.M	402,00
Cat.10	247,00		
Cat.11	282,00		
Cat.12	318,00		
Cat.13	361,00		

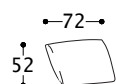

1SM MCBR

ARM-KISSEN

1SM MCBR		2SM RCBR	
Cat.3	148,00	Cat.E	208,00
Cat.4	172,00	Cat.F	281,00
Cat.5	190,00	Cat.G	312,00
Cat.6	208,00	Cat.H	363,00
Cat.7	232,00	Cat.I	428,00
Cat.8	255,00	Cat.L	467,00
Cat.9	327,00	Cat.M	519,00
Cat.10	374,00		
Cat.11	428,00		
Cat.12	481,00		
Cat.13	546,00		

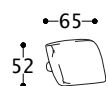

1SM MCJ

RÜCKENKISSEN JOLLY MIT ZYLINDER

1SM MCJ		2SM RCJ	
Cat.3	211,00	Cat.E	328,00
Cat.4	230,00	Cat.F	410,00
Cat.5	245,00	Cat.G	443,00
Cat.6	259,00	Cat.H	502,00
Cat.7	279,00	Cat.I	569,00
Cat.8	298,00	Cat.L	613,00
Cat.9	357,00	Cat.M	671,00
Cat.10	396,00		
Cat.11	439,00		
Cat.12	483,00		
Cat.13	536,00		

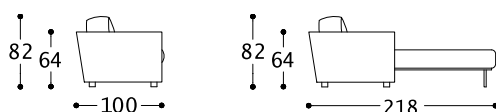

07 S74 N/E D. ORANGE 03.2023

BEZÜGE SIND ABNEHMBAR. DIESES MODELL KANN NUR MIT EINZIGEN STOFF BEZOGEN WERDEN. GESTREIFTE STOFFE ODER STOFFE MIT MUSTERN EIGNEN SICH NICHT FÜR DIESES MODELL. LIEFERBAR AUCH AUS KUNSTLEDER (NICHT ABNEHMBAR). ARTIKEL MIT HOHER LATTENROST HABEN DIE SITZHÖHE 53 CM.; ARTIKEL MIT NIEDRIGER LATTENROST HABEN DIE SITZHÖHE 48 CM. DAS MODELL IST MIT BOX FÜR KISSEN VERSEHEN. DIE ELEMENTE WERDEN MIT KARTON VERPACKT, ZERLEGT GELIEFERT UND IN 3 KOLLI GETEILT: SOFA, LATTENROST UND MATRATZE, ARMLEHNEN.

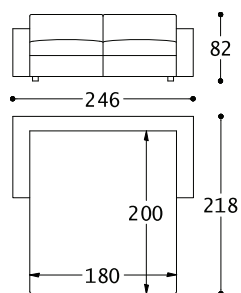

1SNST3MEBM814

DREISITZSOFA MAXI MIT NIEDRIGEM ELEKTROGESCHWEISSTEM LATTENROST UND FEDERKERNMATRATZE, H. 14 CM

1SNST3MEBM814

Cat.3	5.194,00
Cat.4	5.368,00
Cat.5	5.718,00
Cat.6	5.854,00
Cat.7	6.035,00
Cat.8	6.216,00
Cat.9	6.758,00
Cat.10	7.120,00
Cat.11	7.527,00
Cat.12	7.934,00
Cat.13	8.432,00

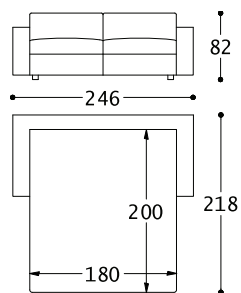

1SNST3MEBP812

DREISITZSOFA MAXI MIT NIEDRIGEM ELEKTROGESCHWEISSTEM LATTENROST UND POLYURETHANSCHAUM-MATRATZE, H. 12 CM

1SNST3MEBP812

Cat.3	5.247,00
Cat.4	5.421,00
Cat.5	5.773,00
Cat.6	5.909,00
Cat.7	6.090,00
Cat.8	6.271,00
Cat.9	6.814,00
Cat.10	7.175,00
Cat.11	7.582,00
Cat.12	7.990,00
Cat.13	8.487,00

07 S74 N/E D. ORANGE 03.2023

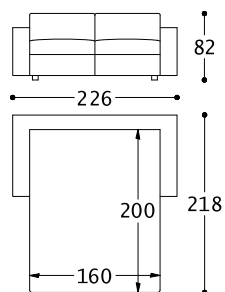

1SNST3ADI618

DREISITZSOFA MIT HOHEM LATTENROST,
BREITEN DAUBEN UND
TASCHENFEDERKERNMATRATZE, H. 17 CM

1SNST3ADI618

Cat.3	5.225,00
Cat.4	5.392,00
Cat.5	5.738,00
Cat.6	5.868,00
Cat.7	6.041,00
Cat.8	6.215,00
Cat.9	6.735,00
Cat.10	7.082,00
Cat.11	7.473,00
Cat.12	7.863,00
Cat.13	8.341,00

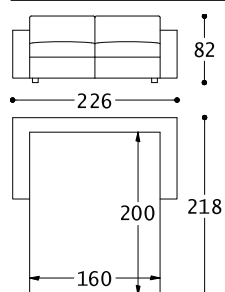

1SNST3ADM618

DREISITZSOFA MIT HOHEM LATTENROST,
BREITEN DAUBEN UND
FEDERKERNMATRATZE, H. 17 CM

1SNST3ADM618

Cat.3	4.782,00
Cat.4	4.949,00
Cat.5	5.277,00
Cat.6	5.408,00
Cat.7	5.581,00
Cat.8	5.755,00
Cat.9	6.275,00
Cat.10	6.622,00
Cat.11	7.013,00
Cat.12	7.403,00
Cat.13	7.880,00

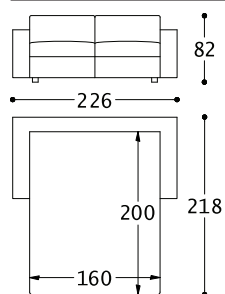

1SNST3EAI618

DREISITZSOFA MIT HOHEM
ELEKTROGESCHWEISSTEM LATTENROST
UND TASCHENFEDERKERNMATRATZE, H.
17 CM

1SNST3EAI618

Cat.3	5.122,00
Cat.4	5.289,00
Cat.5	5.631,00
Cat.6	5.761,00
Cat.7	5.934,00
Cat.8	6.108,00
Cat.9	6.628,00
Cat.10	6.975,00
Cat.11	7.366,00
Cat.12	7.756,00
Cat.13	8.234,00

07 S74 N/E D. ORANGE 03.2023

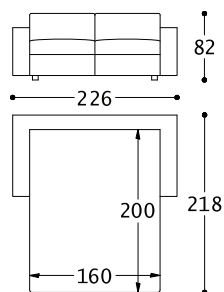

1SNST3EAM618

DREISITZSOFA MIT HOHEM
ELEKTROGESCHWEISSTEM LATTENROST
UND FEDERKERNMATRATZE, H. 17 CM

1SNST3EAM618

Cat.3	4.650,00
Cat.4	4.817,00
Cat.5	5.140,00
Cat.6	5.270,00
Cat.7	5.443,00
Cat.8	5.617,00
Cat.9	6.138,00
Cat.10	6.485,00
Cat.11	6.875,00
Cat.12	7.265,00
Cat.13	7.743,00

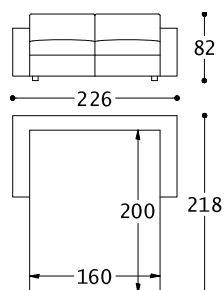

1SNST3EBM614

DREISITZSOFA MIT NIEDRIGEM
ELEKTROGESCHWEISSTEM LATTENROST
UND FEDERKERNMATRATZE, H. 14 CM

1SNST3EBM614

Cat.3	4.765,00
Cat.4	4.932,00
Cat.5	5.259,00
Cat.6	5.389,00
Cat.7	5.563,00
Cat.8	5.736,00
Cat.9	6.257,00
Cat.10	6.604,00
Cat.11	6.994,00
Cat.12	7.385,00
Cat.13	7.862,00

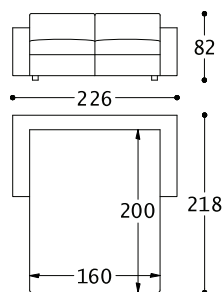

1SNST3EBP612

DREISITZSOFA MIT NIEDRIGEM
ELEKTROGESCHWEISSTEM LATTENROST
UND POLYURETHANSCHAUM-MATRATZE,
H. 12 CM

1SNST3EBP612

Cat.3	4.903,00
Cat.4	5.070,00
Cat.5	5.403,00
Cat.6	5.533,00
Cat.7	5.707,00
Cat.8	5.880,00
Cat.9	6.401,00
Cat.10	6.748,00
Cat.11	7.138,00
Cat.12	7.529,00
Cat.13	8.006,00

07 S74 N/E D. ORANGE 03.2023

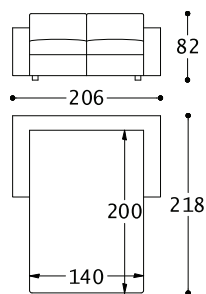

1SNST2ADI418

ZWEISITZSOFA MIT HOHEM LATTENROST,
BREITEN DAUBEN UND
TASCHENFEDERKERNMATRATZE, H. 17 CM

1SNST2ADI418

Cat.3	5.025,00
Cat.4	5.192,00
Cat.5	5.530,00
Cat.6	5.660,00
Cat.7	5.834,00
Cat.8	6.007,00
Cat.9	6.528,00
Cat.10	6.875,00
Cat.11	7.265,00
Cat.12	7.656,00
Cat.13	8.133,00

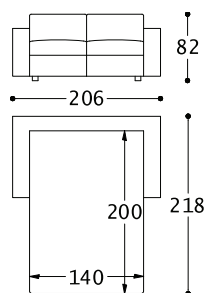

1SNST2ADM418

ZWEISITZSOFA MIT HOHEM LATTENROST,
BREITEN DAUBEN UND
FEDERKERNMATRATZE, H. 17 CM

1SNST2ADM418

Cat.3	4.526,00
Cat.4	4.693,00
Cat.5	5.011,00
Cat.6	5.141,00
Cat.7	5.314,00
Cat.8	5.488,00
Cat.9	6.008,00
Cat.10	6.355,00
Cat.11	6.746,00
Cat.12	7.136,00
Cat.13	7.614,00

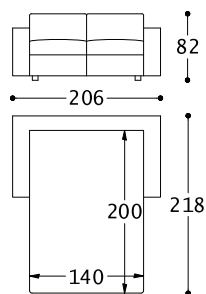

1SNST2EAI418

ZWEISITZSOFA MIT HOHEM
ELEKTROGESCHWEISSTEM LATTENROST
UND TASCHENFEDERKERNMATRATZE, H.
17 CM

1SNST2EAI418

Cat.3	4.873,00
Cat.4	5.040,00
Cat.5	5.372,00
Cat.6	5.502,00
Cat.7	5.675,00
Cat.8	5.849,00
Cat.9	6.370,00
Cat.10	6.717,00
Cat.11	7.107,00
Cat.12	7.497,00
Cat.13	7.975,00

07 S74 N/E D. ORANGE 03.2023

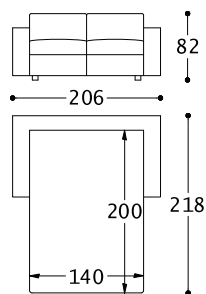

1SNST2EAM418

ZWEISITZSOFA MIT HOHEM
ELEKTROGESCHWEISSTEM LATTENROST
UND FEDERKERNMATRATZE, H. 17 CM

1SNST2EAM418

Cat.3	4.344,00
Cat.4	4.511,00
Cat.5	4.822,00
Cat.6	4.952,00
Cat.7	5.125,00
Cat.8	5.299,00
Cat.9	5.819,00
Cat.10	6.167,00
Cat.11	6.557,00
Cat.12	6.947,00
Cat.13	7.425,00

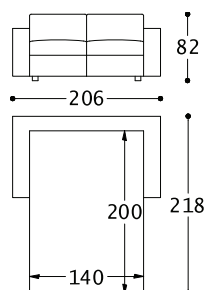

1SNST2EBM414

ZWEISITZSOFA MIT NIEDRIGEM
ELEKTROGESCHWEISSTEM LATTENROST
UNDFEDERKERNMATRATZE, H. 14 CM

1SNST2EBM414

Cat.3	4.392,00
Cat.4	4.559,00
Cat.5	4.871,00
Cat.6	5.001,00
Cat.7	5.175,00
Cat.8	5.349,00
Cat.9	5.869,00
Cat.10	6.216,00
Cat.11	6.607,00
Cat.12	6.997,00
Cat.13	7.474,00

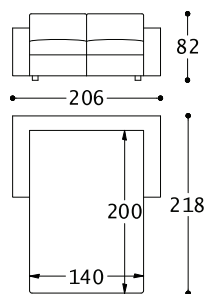

1SNST2EBP412

ZWEISITZSOFA MIT NIEDRIGEM
ELEKTROGESCHWEISSTEM LATTENROST
UND POLYURETHANSCHAUM-MATRATZE,
H. 12 CM

1SNST2EBP412

Cat.3	4.438,00
Cat.4	4.604,00
Cat.5	4.919,00
Cat.6	5.049,00
Cat.7	5.222,00
Cat.8	5.396,00
Cat.9	5.917,00
Cat.10	6.264,00
Cat.11	6.654,00
Cat.12	7.044,00
Cat.13	7.522,00

07 S74 N/E D. ORANGE 03.2023

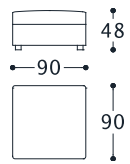

1SNSPOUFF

HOCKER

1SNSPOUFF	
Cat.3	893,00
Cat.4	949,00
Cat.5	1.032,00
Cat.6	1.076,00
Cat.7	1.135,00
Cat.8	1.194,00
Cat.9	1.371,00
Cat.10	1.489,00
Cat.11	1.622,00
Cat.12	1.755,00
Cat.13	1.918,00

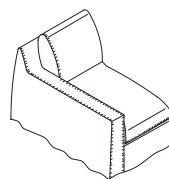
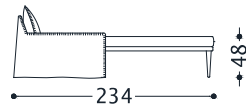
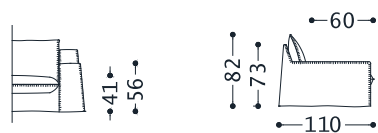

THEO

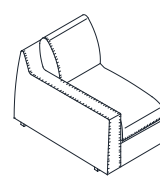

THEO 2

07 S74 N/E D. ORANGE 03.2023

DIE STOFF-VERSION IST ABNEHMBAR UND MAN KANN RÜCKENKISSEN, SITZKISSEN UND CHASSIS MIT UNTERSCHIEDLICHEN STOFFEN BEZIEHEN. GESTREIFTE STOFFE ODER STOFFE MIT MUSTERN EIGNEN SICH FÜR DIESES MODELL. MODELL AUS KUNSTLEDER NICHT VERFÜGBAR . NAHT "PUNTO CAVALLO". IMMER GEWÜNSCHTE FARBEN DES FADEN ANGEBEN, DIE BESTELNUMMERN SIND FOLGENDE: KOD.35701 WEISS - KOD.69385 BEIGE - KOD.35835 GRAU - KOD.69197 ANTHRAXIT GRAU - KOD.35767 BRAUN - KOD.790 DUNKELBRAUN - KOD.35907 SCHWARZ. DAS FADEN WIRD IN DER FARBE DES ELEMENTE DELIEFERT, WENN NICHT ANGEGBEN. AUF WUNSCH KANN MAN AUCH OHNE NAHT "PUNTO CAVALLO" DELIEFERT. ALLE ELEMENTE MIT ARMLEHNEN, B. 31 CM. DER "SMALL" SESSEL MIT ARMLEHNEN, B. 13 CM. DIE SCHLAFSOFAS SIND MIT POLYURETHANSCHAUMMATRATZE H. 11 CM DELIEFERT. MÖGLICH AUCH OHNE ROCK VERFÜGBAR (MODELL THEO2-KODE TH2): UM DIE BESTELLUNG DES SOFAELEMENTE ZU ERTEILEN, MUSS MAN DEN KODE "TET/THO" MIT DEM KODE "TH2" ERSETZEN. ZB.: 1TETD3/2THOD3 = Dreisitzer-Sofa mod. Theo; 1TH2D3/2TH2D3 = Dreisitzer-Sofa mod. Theo 2.

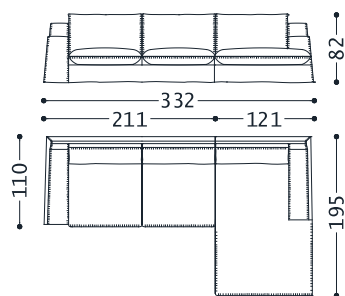

0TETC1

1 DORMEUSE ARMLEHNE RECHTS
1 DREI SITZER SOFA ARMLEHNE LINKS

0TETC1		0THOC1	
Cat.3	4.809,00	Cat.E	6.498,00
Cat.4	5.095,00	Cat.F	7.998,00
Cat.5	5.310,00	Cat.G	8.686,00
Cat.6	5.525,00	Cat.H	9.687,00
Cat.7	5.812,00	Cat.I	11.625,00
Cat.8	6.098,00	Cat.L	12.501,00
Cat.9	6.957,00	Cat.M	13.626,00
Cat.10	7.530,00		
Cat.11	8.175,00		
Cat.12	8.820,00		
Cat.13	9.608,00		

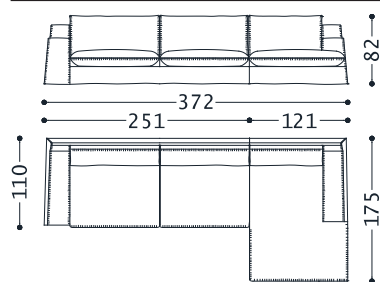

0TETC7

1 SMALL DORMEUSE ARMLEHNE RECHTS
1 DREI SITZER MAXI SOFA ARMLEHNE LINKS

0TETC7		0THOC7	
Cat.3	5.152,00	Cat.E	6.865,00
Cat.4	5.446,00	Cat.F	8.457,00
Cat.5	5.667,00	Cat.G	9.187,00
Cat.6	5.888,00	Cat.H	10.248,00
Cat.7	6.183,00	Cat.I	12.305,00
Cat.8	6.476,00	Cat.L	13.233,00
Cat.9	7.360,00	Cat.M	14.428,00
Cat.10	7.949,00		
Cat.11	8.611,00		
Cat.12	9.274,00		
Cat.13	10.084,00		

07 S74 N/E D. ORANGE 03.2023

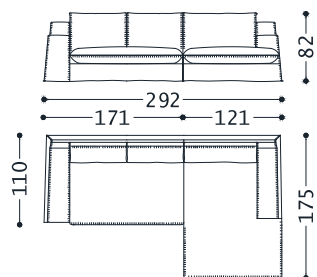

0TETC6

1 SMALL DORMEUSE ARMLEHNE RECHTS
1 ZWEI SITZER SOFA ARMLEHNE LINKS
(EINZIGES SITZKISSEN)

0TETC6	
Cat.3	4.416,00
Cat.4	4.694,00
Cat.5	4.903,00
Cat.6	5.112,00
Cat.7	5.391,00
Cat.8	5.669,00
Cat.9	6.505,00
Cat.10	7.062,00
Cat.11	7.688,00
Cat.12	8.315,00
Cat.13	9.081,00

0THOC6	
Cat.E	5.881,00
Cat.F	7.199,00
Cat.G	7.804,00
Cat.H	8.684,00
Cat.I	10.389,00
Cat.L	11.158,00
Cat.M	12.148,00

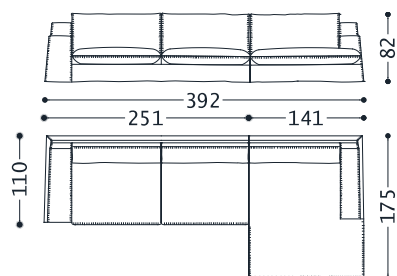

0THOC3

1 MAXI DORMEUSE ARMLEHNE RECHTS
1 DREI SITZER MAXI SOFA ARMLEHNE
LINKS

0THOC3	
Cat.E	7.209,00
Cat.F	8.891,00
Cat.G	9.662,00
Cat.H	10.782,00
Cat.I	12.955,00
Cat.L	13.935,00
Cat.M	15.197,00

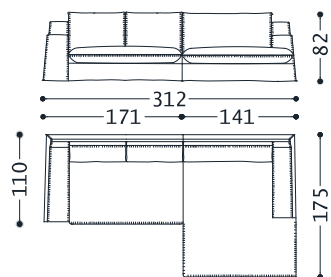

0THOC2

1 MAXI DORMEUSE ARMLEHNE RECHTS
1 ZWEI SITZER SOFA ARMLEHNE LINKS
(EINZIGES SITZKISSEN)

0THOC2	
Cat.E	6.225,00
Cat.F	7.633,00
Cat.G	8.279,00
Cat.H	9.218,00
Cat.I	11.039,00
Cat.L	11.860,00
Cat.M	12.917,00

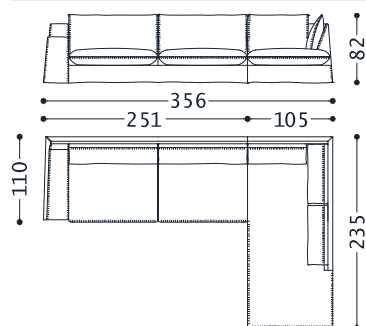

0TETC4

1 DREI SITZER MAXI SOFA ARMLEHNE
LINKS
1 MERIDIENNE RECHTS

0TETC4	
Cat.3	5.842,00
Cat.4	6.204,00
Cat.5	6.475,00
Cat.6	6.746,00
Cat.7	7.107,00
Cat.8	7.468,00
Cat.9	8.552,00
Cat.10	9.275,00
Cat.11	10.088,00
Cat.12	10.901,00
Cat.13	11.895,00

0THOC4	
Cat.E	7.775,00
Cat.F	9.651,00
Cat.G	10.511,00
Cat.H	11.761,00
Cat.I	14.184,00
Cat.L	15.278,00
Cat.M	16.685,00

07 S74 N/E D. ORANGE 03.2023

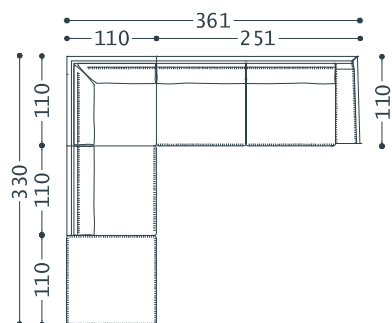

OTETC9

1 ECHELEMENT
1 DREI SITZER MAXI SOFA ARMLEHNE RECHTS
1 QUADRATISCHER HOCKER
1 MAXI ZENTRAL SESSEL

OTETC9	
Cat.3	7.571,00
Cat.4	8.018,00
Cat.5	8.353,00
Cat.6	8.689,00
Cat.7	9.136,00
Cat.8	9.582,00
Cat.9	10.923,00
Cat.10	11.817,00
Cat.11	12.824,00
Cat.12	13.831,00
Cat.13	15.061,00

OTHOC9	
Cat.E	9.918,00
Cat.F	12.266,00
Cat.G	13.343,00
Cat.H	14.909,00
Cat.I	17.944,00
Cat.L	19.313,00
Cat.M	21.076,00

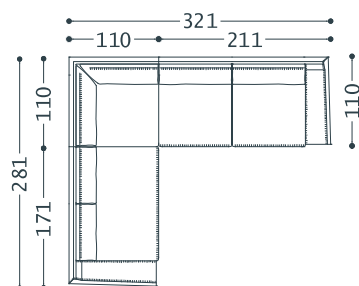

OTETC8

1 ECHELEMENT
1 ZWEI SITZER SOFA ARMLEHNE LINKS (EINZIGES SITZKISSEN)
1 DREI SITZER SOFA ARMLEHNE RECHTS

OTETC8	
Cat.3	6.805,00
Cat.4	7.235,00
Cat.5	7.558,00
Cat.6	7.881,00
Cat.7	8.312,00
Cat.8	8.742,00
Cat.9	10.033,00
Cat.10	10.894,00
Cat.11	11.863,00
Cat.12	12.832,00
Cat.13	14.016,00

OTHOC8	
Cat.E	9.074,00
Cat.F	11.157,00
Cat.G	12.113,00
Cat.H	13.504,00
Cat.I	16.198,00
Cat.L	17.414,00
Cat.M	18.978,00

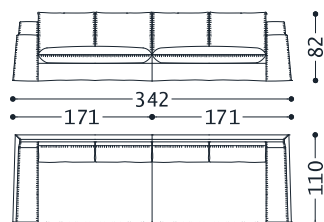

OTETC5

1 ZWEI SITZER SOFA ARMLEHNE RECHTS (EINZIGES SITZKISSEN)
1 ZWEI SITZER SOFA ARMLEHNE LINKS (EINZIGES SITZKISSEN)

OTETC5	
Cat.3	4.378,00
Cat.4	4.682,00
Cat.5	4.910,00
Cat.6	5.138,00
Cat.7	5.442,00
Cat.8	5.746,00
Cat.9	6.658,00
Cat.10	7.266,00
Cat.11	7.950,00
Cat.12	8.634,00
Cat.13	9.470,00

OTHOC5	
Cat.E	5.892,00
Cat.F	7.260,00
Cat.G	7.888,00
Cat.H	8.802,00
Cat.I	10.572,00
Cat.L	11.370,00
Cat.M	12.398,00

07 S74 N/E D. ORANGE 03.2023

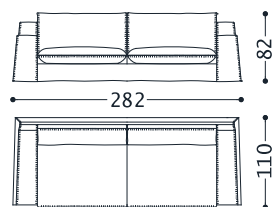

1TETD3M

DREI SITZER MAXI SOFA

1TETD3M		2THOD3M	
Cat.3	3.121,00	Cat.E	4.216,00
Cat.4	3.302,00	Cat.F	5.272,00
Cat.5	3.438,00	Cat.G	5.756,00
Cat.6	3.574,00	Cat.H	6.460,00
Cat.7	3.755,00	Cat.I	7.823,00
Cat.8	3.936,00	Cat.L	8.439,00
Cat.9	4.479,00	Cat.M	9.231,00
Cat.10	4.841,00		
Cat.11	5.248,00		
Cat.12	5.655,00		
Cat.13	6.153,00		

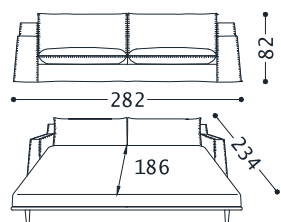

1TETD3MEP

DREI SITZER MAXI SOFA MIT
ELEKTROGESCHWEISSTEM METALLROST
UND POLYURETHANMATRATZE

1TETD3MEP		2THOD3MEP	
Cat.3	3.949,00	Cat.E	5.073,00
Cat.4	4.130,00	Cat.F	6.151,00
Cat.5	4.266,00	Cat.G	6.645,00
Cat.6	4.402,00	Cat.H	7.363,00
Cat.7	4.583,00	Cat.I	8.755,00
Cat.8	4.764,00	Cat.L	9.383,00
Cat.9	5.307,00	Cat.M	10.191,00
Cat.10	5.669,00		
Cat.11	6.076,00		
Cat.12	6.484,00		
Cat.13	6.982,00		

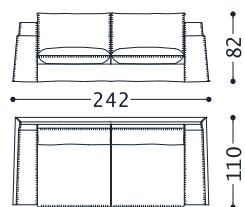

1TETD3

DREI SITZER SOFA

1TETD3		2THOD3	
Cat.3	2.796,00	Cat.E	3.812,00
Cat.4	2.961,00	Cat.F	4.728,00
Cat.5	3.085,00	Cat.G	5.148,00
Cat.6	3.209,00	Cat.H	5.759,00
Cat.7	3.374,00	Cat.I	6.942,00
Cat.8	3.539,00	Cat.L	7.476,00
Cat.9	4.034,00	Cat.M	8.164,00
Cat.10	4.364,00		
Cat.11	4.735,00		
Cat.12	5.107,00		
Cat.13	5.560,00		

07 S74 N/E D. ORANGE 03.2023

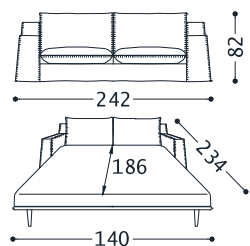

1TETD3EP

DREI SITZER SOFA MIT
ELEKTROGESCHWEISSTEM METALLROST
UND POLYURETHANMATRATZE

1TETD3EP		2THOD3EP	
Cat.3	3.581,00	Cat.E	4.563,00
Cat.4	3.746,00	Cat.F	5.501,00
Cat.5	3.869,00	Cat.G	5.931,00
Cat.6	3.993,00	Cat.H	6.556,00
Cat.7	4.158,00	Cat.I	7.768,00
Cat.8	4.323,00	Cat.L	8.315,00
Cat.9	4.818,00	Cat.M	9.018,00
Cat.10	5.148,00		
Cat.11	5.520,00		
Cat.12	5.891,00		
Cat.13	6.345,00		

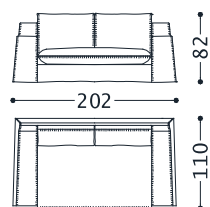

1TETD2

ZWEI SITZER SOFA (EINZIGES SITZKISSEN)

1TETD2		2THOD2	
Cat.3	2.397,00	Cat.E	3.235,00
Cat.4	2.559,00	Cat.F	4.012,00
Cat.5	2.682,00	Cat.G	4.368,00
Cat.6	2.804,00	Cat.H	4.885,00
Cat.7	2.967,00	Cat.I	5.888,00
Cat.8	3.129,00	Cat.L	6.341,00
Cat.9	3.618,00	Cat.M	6.923,00
Cat.10	3.944,00		
Cat.11	4.310,00		
Cat.12	4.677,00		
Cat.13	5.124,00		

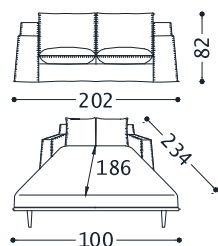

1TETD2EP

ZWEI SITZER SOFA MIT
ELEKTROGESCHWEISSTEM METALLROST
UND POLYURETHANMATRATZE (EINZIGES
SITZKISSEN)

1TETD2EP		2THOD2EP	
Cat.3	3.132,00	Cat.E	3.934,00
Cat.4	3.294,00	Cat.F	4.732,00
Cat.5	3.417,00	Cat.G	5.098,00
Cat.6	3.539,00	Cat.H	5.630,00
Cat.7	3.702,00	Cat.I	6.661,00
Cat.8	3.864,00	Cat.L	7.127,00
Cat.9	4.353,00	Cat.M	7.726,00
Cat.10	4.679,00		
Cat.11	5.045,00		
Cat.12	5.412,00		
Cat.13	5.859,00		

07 S74 N/E D. ORANGE 03.2023

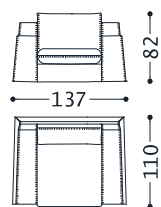

1TETPL

LARGE SESSEL

1TETPL		2THOPL	
Cat.3	1.791,00	Cat.E	2.343,00
Cat.4	1.896,00	Cat.F	2.913,00
Cat.5	1.974,00	Cat.G	3.174,00
Cat.6	2.053,00	Cat.H	3.553,00
Cat.7	2.158,00	Cat.I	4.288,00
Cat.8	2.262,00	Cat.L	4.621,00
Cat.9	2.576,00	Cat.M	5.047,00
Cat.10	2.786,00		
Cat.11	3.021,00		
Cat.12	3.257,00		
Cat.13	3.545,00		

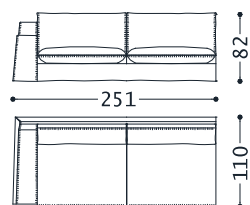

1TETD3MSX

DREI SITZER MAXI SOFA ARMLEHNE LINKS
DREI SITZER MAXI SOFA ARMLEHNE
RECHTS

1TETD3MSX		2THOD3MSX	
1TETD3MDX		2THOD3MDX	
Cat.3	2.925,00	Cat.E	3.930,00
Cat.4	3.093,00	Cat.F	4.888,00
Cat.5	3.219,00	Cat.G	5.327,00
Cat.6	3.345,00	Cat.H	5.965,00
Cat.7	3.513,00	Cat.I	7.202,00
Cat.8	3.680,00	Cat.L	7.760,00
Cat.9	4.184,00	Cat.M	8.479,00
Cat.10	4.520,00		
Cat.11	4.898,00		
Cat.12	5.276,00		
Cat.13	5.738,00		

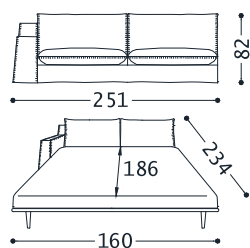

1TETD3MSXEP

DREI SITZER MAXI SOFA ARMLEHNE LINKS
MIT ELEKTROGESCHWEISSTEM
METALLROST UND
POLYURETHANMATRATZE
DREI SITZER MAXI SOFA ARMLEHNE
RECHTS MIT ELEKTROGESCHWEISSTEM
METALLROST UND
POLYURETHANMATRATZE

1TETD3MSXEP		2THOD3MSXEP	
1TETD3MDXEP		2THOD3MDXEP	
Cat.3	3.624,00	Cat.E	4.667,00
Cat.4	3.792,00	Cat.F	5.647,00
Cat.5	3.918,00	Cat.G	6.096,00
Cat.6	4.044,00	Cat.H	6.748,00
Cat.7	4.212,00	Cat.I	8.013,00
Cat.8	4.379,00	Cat.L	8.585,00
Cat.9	4.883,00	Cat.M	9.319,00
Cat.10	5.219,00		
Cat.11	5.597,00		
Cat.12	5.975,00		
Cat.13	6.437,00		

07 S74 N/E D. ORANGE 03.2023

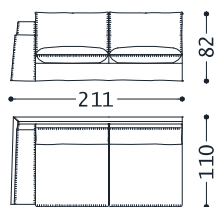

1TETD3SX

DREI SITZER SOFA ARMLEHNE LINKS
DREI SITZER SOFA ARMLEHNE RECHTS

1TETD3SX		2THOD3SX	
1TETD3DX		2THOD3DX	
Cat.3	2.593,00	Cat.E	3.524,00
Cat.4	2.750,00	Cat.F	4.348,00
Cat.5	2.868,00	Cat.G	4.726,00
Cat.6	2.986,00	Cat.H	5.276,00
Cat.7	3.143,00	Cat.I	6.341,00
Cat.8	3.300,00	Cat.L	6.822,00
Cat.9	3.771,00	Cat.M	7.440,00
Cat.10	4.085,00		
Cat.11	4.439,00		
Cat.12	4.792,00		
Cat.13	5.224,00		

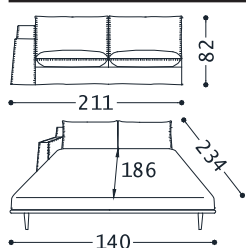

1TETD3SXE

DREI SITZER SOFA ARMLEHNE LINKS MIT
ELEKTROGESCHWEISSTEM METALLROST
UND POLYURETHANMATRATZE
DREI SITZER SOFA ARMLEHNE RECHTS MIT
ELEKTROGESCHWEISSTEM METALLROST
UND POLYURETHANMATRATZE

1TETD3SXE		2THOD3SXE	
1TETD3DXE		2THOD3DXE	
Cat.3	3.369,00	Cat.E	4.270,00
Cat.4	3.526,00	Cat.F	5.112,00
Cat.5	3.644,00	Cat.G	5.498,00
Cat.6	3.761,00	Cat.H	6.059,00
Cat.7	3.918,00	Cat.I	7.146,00
Cat.8	4.075,00	Cat.L	7.638,00
Cat.9	4.547,00	Cat.M	8.269,00
Cat.10	4.861,00		
Cat.11	5.214,00		
Cat.12	5.567,00		
Cat.13	5.999,00		

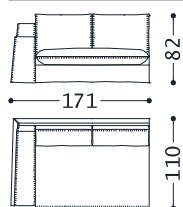

1TETD2SX

ZWEI SITZER SOFA ARMLEHNE LINKS
(EINZIGES SITZKISSEN)
ZWEI SITZER SOFA ARMLEHNE RECHTS
(EINZIGES SITZKISSEN)

1TETD2SX		2THOD2SX	
1TETD2DX		2THOD2DX	
Cat.3	2.189,00	Cat.E	2.946,00
Cat.4	2.341,00	Cat.F	3.630,00
Cat.5	2.455,00	Cat.G	3.944,00
Cat.6	2.569,00	Cat.H	4.401,00
Cat.7	2.721,00	Cat.I	5.286,00
Cat.8	2.873,00	Cat.L	5.685,00
Cat.9	3.329,00	Cat.M	6.199,00
Cat.10	3.633,00		
Cat.11	3.975,00		
Cat.12	4.317,00		
Cat.13	4.735,00		

07 S74 N/E D. ORANGE 03.2023

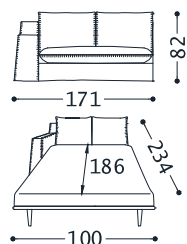

1TETD2SXEP

ZWEI SITZER SOFA ARMLEHNE LINKS MIT ELEKTROGESCHWEISSTEM METALLROST UND POLYURETHANMATRATZE (EINZIGES SITZKISSEN)
ZWEI SITZER SOFA ARMLEHNE RECHTS MIT ELEKTROGESCHWEISSTEM METALLROST UND POLYURETHANMATRATZE (EINZIGES SITZKISSEN)

1TETD2SXEP		2THOD2SXEP	
1TETD2DXEP		2THOD2DXEP	
Cat.3	2.915,00	Cat.E	3.649,00
Cat.4	3.067,00	Cat.F	4.361,00
Cat.5	3.181,00	Cat.G	4.686,00
Cat.6	3.295,00	Cat.H	5.160,00
Cat.7	3.447,00	Cat.I	6.079,00
Cat.8	3.599,00	Cat.L	6.494,00
Cat.9	4.055,00	Cat.M	7.027,00
Cat.10	4.359,00		
Cat.11	4.701,00		
Cat.12	5.043,00		
Cat.13	5.461,00		

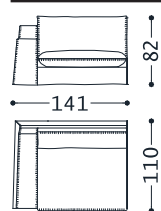

1TETPMSX

MAXI SESSEL ARMLEHNE LINKS
MAXI SESSEL ARMLEHNE RECHTS

1TETPMSX		2THOPMSX	
1TETPMDX		2THOPMDX	
Cat.3	1.764,00	Cat.E	2.321,00
Cat.4	1.873,00	Cat.F	2.883,00
Cat.5	1.955,00	Cat.G	3.141,00
Cat.6	2.037,00	Cat.H	3.516,00
Cat.7	2.146,00	Cat.I	4.243,00
Cat.8	2.255,00	Cat.L	4.572,00
Cat.9	2.582,00	Cat.M	4.994,00
Cat.10	2.800,00		
Cat.11	3.046,00		
Cat.12	3.291,00		
Cat.13	3.591,00		

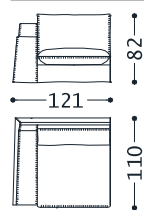

1TETPSX

SESSEL ARMLEHNE LINKS
SESSEL ARMLEHNE RECHTS

1TETPSX		2THOPSX	
1TETPDX		2THOPDX	
Cat.3	1.530,00	Cat.E	2.015,00
Cat.4	1.626,00	Cat.F	2.504,00
Cat.5	1.697,00	Cat.G	2.727,00
Cat.6	1.769,00	Cat.H	3.053,00
Cat.7	1.865,00	Cat.I	3.684,00
Cat.8	1.961,00	Cat.L	3.969,00
Cat.9	2.249,00	Cat.M	4.336,00
Cat.10	2.441,00		
Cat.11	2.657,00		
Cat.12	2.873,00		
Cat.13	3.137,00		

07 S74 N/E D. ORANGE 03.2023

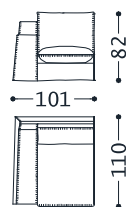

1TETPSSX

SMALL SESSEL ARMLEHNE LINKS
SMALL SESSEL ARMLEHNE RECHTS

1TETPSSX		2THOPSSX	
1TETPSDX		2THOPSDX	
Cat.3	1.403,00	Cat.E	1.810,00
Cat.4	1.495,00	Cat.F	2.231,00
Cat.5	1.565,00	Cat.G	2.423,00
Cat.6	1.634,00	Cat.H	2.704,00
Cat.7	1.726,00	Cat.I	3.248,00
Cat.8	1.819,00	Cat.L	3.493,00
Cat.9	2.096,00	Cat.M	3.809,00
Cat.10	2.280,00		
Cat.11	2.488,00		
Cat.12	2.696,00		
Cat.13	2.950,00		

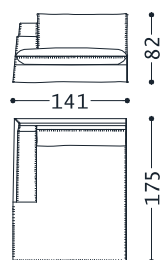

2THODORMXSX

MAXI DORMEUSE ARMLEHNE LINKS
MAXI DORMEUSE ARMLEHNE RECHTS

2THODORMXSX	
2THODORMDX	
Cat.E	3.279,00
Cat.F	4.003,00
Cat.G	4.335,00
Cat.H	4.817,00
Cat.I	5.753,00
Cat.L	6.175,00
Cat.M	6.718,00

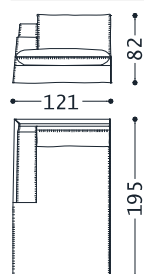

1TETDORMSX

DORMEUSE ARMLEHNE LINKS
DORMEUSE ARMLEHNE RECHTS

1TETDORMSX		2THODORMSX	
1TETDORMDX		2THODORMDX	
Cat.3	2.216,00	Cat.E	2.974,00
Cat.4	2.345,00	Cat.F	3.650,00
Cat.5	2.442,00	Cat.G	3.960,00
Cat.6	2.539,00	Cat.H	4.411,00
Cat.7	2.669,00	Cat.I	5.284,00
Cat.8	2.798,00	Cat.L	5.679,00
Cat.9	3.186,00	Cat.M	6.186,00
Cat.10	3.445,00		
Cat.11	3.736,00		
Cat.12	4.028,00		
Cat.13	4.384,00		

07 S74 N/E D. ORANGE 03.2023

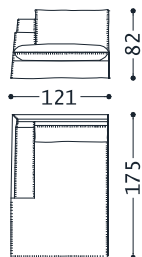

1TETDORSSX

SMALL DORMEUSE ARMLEHNE LINKS
SMALL DORMEUSE ARMLEHNE RECHTS

1TETDORSSX		2THODORSSX	
1TETDORS DX		2THODORS DX	
Cat.3	2.227,00	Cat.E	2.935,00
Cat.4	2.353,00	Cat.F	3.569,00
Cat.5	2.448,00	Cat.G	3.860,00
Cat.6	2.543,00	Cat.H	4.283,00
Cat.7	2.670,00	Cat.I	5.103,00
Cat.8	2.796,00	Cat.L	5.473,00
Cat.9	3.176,00	Cat.M	5.949,00
Cat.10	3.429,00		
Cat.11	3.713,00		
Cat.12	3.998,00		
Cat.13	4.346,00		

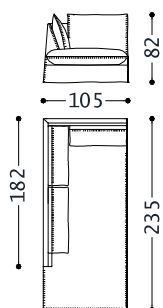

1TETMERSX

MERIDIENNE LINKS
MERIDIENNE RECHTS

1TETMERSX		2THOMERSX	
1TETMER DX		2THOMER DX	
Cat.3	2.917,00	Cat.E	3.845,00
Cat.4	3.111,00	Cat.F	4.763,00
Cat.5	3.256,00	Cat.G	5.184,00
Cat.6	3.401,00	Cat.H	5.796,00
Cat.7	3.594,00	Cat.I	6.982,00
Cat.8	3.788,00	Cat.L	7.518,00
Cat.9	4.368,00	Cat.M	8.206,00
Cat.10	4.755,00		
Cat.11	5.190,00		
Cat.12	5.625,00		
Cat.13	6.157,00		

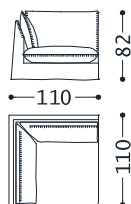

1TETAR

ECKELEMENT

1TETAR		2THOAR	
Cat.3	2.023,00	Cat.E	2.604,00
Cat.4	2.144,00	Cat.F	3.179,00
Cat.5	2.235,00	Cat.G	3.443,00
Cat.6	2.326,00	Cat.H	3.827,00
Cat.7	2.448,00	Cat.I	4.571,00
Cat.8	2.569,00	Cat.L	4.907,00
Cat.9	2.933,00	Cat.M	5.339,00
Cat.10	3.176,00		
Cat.11	3.449,00		
Cat.12	3.723,00		
Cat.13	4.057,00		

07 S74 N/E D. ORANGE 03.2023

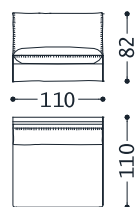

MAXI ZENTRAL SESSEL

1TETPM1

1TETPM1		2THOPM1	
Cat.3	1.483,00	Cat.E	1.934,00
Cat.4	1.580,00	Cat.F	2.401,00
Cat.5	1.652,00	Cat.G	2.615,00
Cat.6	1.725,00	Cat.H	2.926,00
Cat.7	1.821,00	Cat.I	3.529,00
Cat.8	1.918,00	Cat.L	3.801,00
Cat.9	2.208,00	Cat.M	4.151,00
Cat.10	2.401,00		
Cat.11	2.619,00		
Cat.12	2.837,00		
Cat.13	3.103,00		

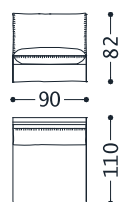

ZENTRAL SESSEL

1TETP1

1TETP1		2THOP1	
Cat.3	1.364,00	Cat.E	1.758,00
Cat.4	1.450,00	Cat.F	2.157,00
Cat.5	1.514,00	Cat.G	2.340,00
Cat.6	1.579,00	Cat.H	2.606,00
Cat.7	1.664,00	Cat.I	3.122,00
Cat.8	1.750,00	Cat.L	3.354,00
Cat.9	2.008,00	Cat.M	3.654,00
Cat.10	2.179,00		
Cat.11	2.372,00		
Cat.12	2.565,00		
Cat.13	2.801,00		

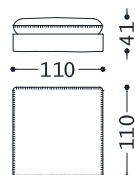

QUADRATISCHER HOCKER

1TETPFFQ

1TETPFFQ		2THOPFFQ	
Cat.3	1.140,00	Cat.E	1.450,00
Cat.4	1.201,00	Cat.F	1.798,00
Cat.5	1.247,00	Cat.G	1.958,00
Cat.6	1.293,00	Cat.H	2.191,00
Cat.7	1.354,00	Cat.I	2.642,00
Cat.8	1.415,00	Cat.L	2.845,00
Cat.9	1.598,00	Cat.M	3.107,00
Cat.10	1.720,00		
Cat.11	1.858,00		
Cat.12	1.995,00		
Cat.13	2.163,00		

07 S74 N/E D. ORANGE 03.2023

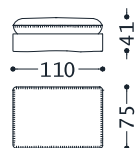

RECHTECKIGER HOCKER

1TETPFFR

1TETPFFR		2THOPFFR	
Cat.3	1.091,00	Cat.E	1.400,00
Cat.4	1.152,00	Cat.F	1.749,00
Cat.5	1.198,00	Cat.G	1.909,00
Cat.6	1.244,00	Cat.H	2.142,00
Cat.7	1.305,00	Cat.I	2.593,00
Cat.8	1.366,00	Cat.L	2.796,00
Cat.9	1.549,00	Cat.M	3.058,00
Cat.10	1.671,00		
Cat.11	1.809,00		
Cat.12	1.946,00		
Cat.13	2.114,00		

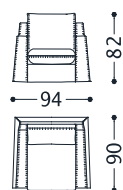

SMALL SESSEL

1TETPC

1TETPC		2THOPC	
Cat.3	1.300,00	Cat.E	1.591,00
Cat.4	1.390,00	Cat.F	1.931,00
Cat.5	1.457,00	Cat.G	2.087,00
Cat.6	1.525,00	Cat.H	2.314,00
Cat.7	1.615,00	Cat.I	2.754,00
Cat.8	1.705,00	Cat.L	2.952,00
Cat.9	1.976,00	Cat.M	3.207,00
Cat.10	2.156,00		
Cat.11	2.359,00		
Cat.12	2.562,00		
Cat.13	2.810,00		

THEO SLIM

Währung: EUR

alberta
Made in Italy

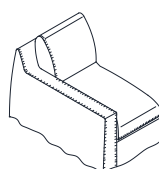
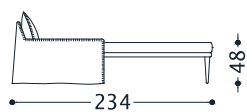
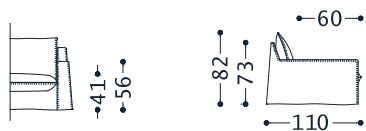

THEO SLIM

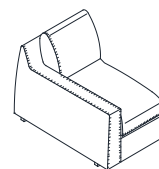

THEO SLIM 2

07 S74 N/E D. ORANGE 03.2023

DIE STOFF-VERSION IST ABNEHMBAR UND MAN KANN RÜCKENKISSEN, SITZKISSEN UND CHASSIS MIT UNTERSCHIEDLICHEN STOFFEN BEZIEHEN. GESTREIFTE STOFFE ODER STOFFE MIT MUSTERN EIGNEN SICH FÜR DIESES MODELL. MODELL AUS KUNSTLEDER NICHT VERFÜGBAR. NAHT "PUNTO CAVALLO". IMMER GEWÜNSCHTE FARBEN DES FADEN ANGEBEN, DIE BESTELNUMMERN SIND FOLGENDE: KOD.35701 WEISS - KOD.69385 BEIGE - KOD.35835 GRAU - KOD.69197 ANTHRAZIT GRAU - KOD.35767 BRAUN - KOD.790 DUNKELBRAUN - KOD.35907 SCHWARZ. DAS FADEN WIRD IN DER FARBE DES ELEMENTE DELIEFERT, WENN NICHT ANGEGBEN. AUF WUNSCH KANN MAN AUCH OHNE NAHT "PUNTO CAVALLO" DELIEFERT. ALLE ELEMENTE MIT ARMLEHNEN, B. 18 CM. DER "SMALL" SESSSEL MIT ARMLEHNEN, B. 13 CM. DIE SCHLAFSOFAS SIND MIT POLYURETHANSCHAUMMATRATZE H. 11 CM DELIEFERT. MÖGLICH AUCH OHNE ROCK VERFÜGBAR (MODELL THEO SLIM 2-Cod. TS2): UM DIE BESTELLUNG DES SOFAELEMENTE ZU ERTEILEN, MUSS MAN DEN KODE " TSL/THS " MIT DEM KODE " TS2" ERSETZEN. ZB.: 1TSLD3/2THSD3 = Dreisitzer-Sofa mod. THEO SLIM; 1TS2D3/2TS2D3 = Dreisitzer-Sofa mod. THEO SLIM 2.

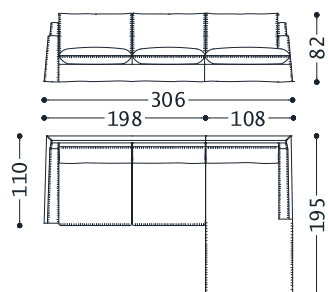

OTSLC1

1 DORMEUSE ARMLEHNE RECHTS
1 DREI SITZER SOFA ARMLEHNE LINKS

OTSLC1		OTHSC1	
Cat.3	4.809,00	Cat.E	6.498,00
Cat.4	5.095,00	Cat.F	7.998,00
Cat.5	5.310,00	Cat.G	8.686,00
Cat.6	5.525,00	Cat.H	9.687,00
Cat.7	5.812,00	Cat.I	11.625,00
Cat.8	6.098,00	Cat.L	12.501,00
Cat.9	6.957,00	Cat.M	13.626,00
Cat.10	7.530,00		
Cat.11	8.175,00		
Cat.12	8.820,00		
Cat.13	9.608,00		

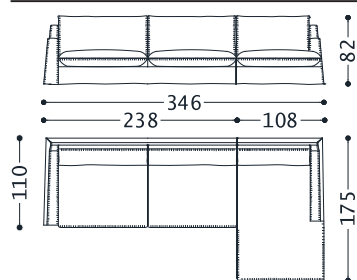

OTSLC7

1 SMALL DORMEUSE ARMLEHNE RECHTS
1 DREI SITZER MAXI SOFA ARMLEHNE LINKS

OTSLC7		OTHSC7	
Cat.3	5.152,00	Cat.E	6.865,00
Cat.4	5.446,00	Cat.F	8.457,00
Cat.5	5.667,00	Cat.G	9.187,00
Cat.6	5.888,00	Cat.H	10.248,00
Cat.7	6.183,00	Cat.I	12.305,00
Cat.8	6.476,00	Cat.L	13.233,00
Cat.9	7.360,00	Cat.M	14.428,00
Cat.10	7.949,00		
Cat.11	8.611,00		
Cat.12	9.274,00		
Cat.13	10.084,00		

07 S74 N/E D. ORANGE 03.2023

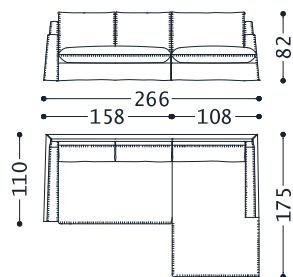

OTSLC6

1 SMALL DORMEUSE ARMLEHNE RECHTS
1 ZWEI SITZER SOFA ARMLEHNE LINKS
(EINZIGES SITZKISSEN)

OTSLC6		OTHSC6	
Cat.3	4.416,00	Cat.E	5.881,00
Cat.4	4.694,00	Cat.F	7.199,00
Cat.5	4.903,00	Cat.G	7.804,00
Cat.6	5.112,00	Cat.H	8.684,00
Cat.7	5.391,00	Cat.I	10.389,00
Cat.8	5.669,00	Cat.L	11.158,00
Cat.9	6.505,00	Cat.M	12.148,00
Cat.10	7.062,00		
Cat.11	7.688,00		
Cat.12	8.315,00		
Cat.13	9.081,00		

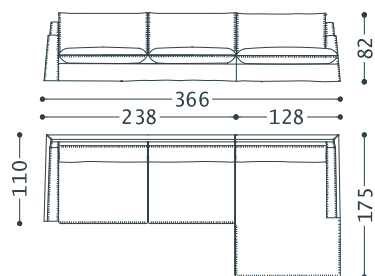

OTHSC3

1 MAXI DORMEUSE ARMLEHNE RECHTS
1 DREI SITZER MAXI SOFA ARMLEHNE
LINKS

OTHSC3	
Cat.E	7.209,00
Cat.F	8.891,00
Cat.G	9.662,00
Cat.H	10.782,00
Cat.I	12.955,00
Cat.L	13.935,00
Cat.M	15.197,00

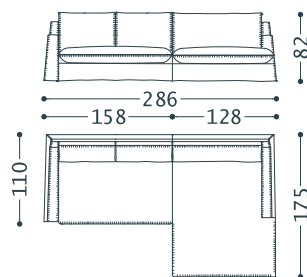

OTHSC2

1 MAXI DORMEUSE ARMLEHNE RECHTS
1 ZWEI SITZER SOFA ARMLEHNE LINKS
(EINZIGES SITZKISSEN)

OTHSC2	
Cat.E	6.225,00
Cat.F	7.633,00
Cat.G	8.279,00
Cat.H	9.218,00
Cat.I	11.039,00
Cat.L	11.860,00
Cat.M	12.917,00

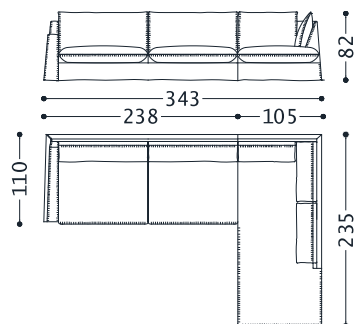

OTSLC4

1 DREI SITZER MAXI SOFA ARMLEHNE
LINKS
1 MERIDIENNE RECHTS

OTSLC4		OTHSC4	
Cat.3	5.842,00	Cat.E	7.775,00
Cat.4	6.204,00	Cat.F	9.651,00
Cat.5	6.475,00	Cat.G	10.511,00
Cat.6	6.746,00	Cat.H	11.761,00
Cat.7	7.107,00	Cat.I	14.184,00
Cat.8	7.468,00	Cat.L	15.278,00
Cat.9	8.552,00	Cat.M	16.685,00
Cat.10	9.275,00		
Cat.11	10.088,00		
Cat.12	10.901,00		
Cat.13	11.895,00		

07 S74 N/E D. ORANGE 03.2023

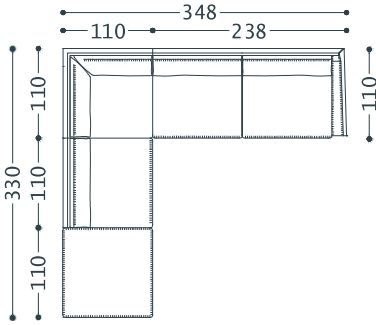

OTSLC9

- 1 ECHELEMENT
- 1 DREI SITZER MAXI SOFA ARMLEHNE RECHTS
- 1 QUADRATISCHER HOCKER
- 1 MAXI ZENTRAL SESSEL

OTSLC9		OTHSC9	
Cat.3	7.571,00	Cat.E	9.918,00
Cat.4	8.018,00	Cat.F	12.266,00
Cat.5	8.353,00	Cat.G	13.343,00
Cat.6	8.689,00	Cat.H	14.909,00
Cat.7	9.136,00	Cat.I	17.944,00
Cat.8	9.582,00	Cat.L	19.313,00
Cat.9	10.923,00	Cat.M	21.076,00
Cat.10	11.817,00		
Cat.11	12.824,00		
Cat.12	13.831,00		
Cat.13	15.061,00		

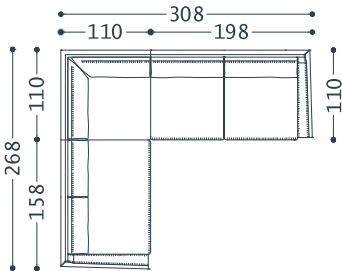

OTSLC8

- 1 ECHELEMENT
- 1 ZWEI SITZER SOFA ARMLEHNE LINKS (EINZIGES SITZKISSEN)
- 1 DREI SITZER SOFA ARMLEHNE RECHTS

OTSLC8		OTHSC8	
Cat.3	6.805,00	Cat.E	9.074,00
Cat.4	7.235,00	Cat.F	11.157,00
Cat.5	7.558,00	Cat.G	12.113,00
Cat.6	7.881,00	Cat.H	13.504,00
Cat.7	8.312,00	Cat.I	16.198,00
Cat.8	8.742,00	Cat.L	17.414,00
Cat.9	10.033,00	Cat.M	18.978,00
Cat.10	10.894,00		
Cat.11	11.863,00		
Cat.12	12.832,00		
Cat.13	14.016,00		

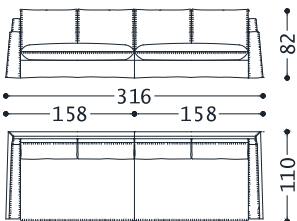

OTSLC5

- 1 ZWEI SITZER SOFA ARMLEHNE RECHTS (EINZIGES SITZKISSEN)
- 1 ZWEI SITZER SOFA ARMLEHNE LINKS (EINZIGES SITZKISSEN)

OTSLC5		OTHSC5	
Cat.3	4.378,00	Cat.E	5.892,00
Cat.4	4.682,00	Cat.F	7.260,00
Cat.5	4.910,00	Cat.G	7.888,00
Cat.6	5.138,00	Cat.H	8.802,00
Cat.7	5.442,00	Cat.I	10.572,00
Cat.8	5.746,00	Cat.L	11.370,00
Cat.9	6.658,00	Cat.M	12.398,00
Cat.10	7.266,00		
Cat.11	7.950,00		
Cat.12	8.634,00		
Cat.13	9.470,00		

07 S74 N/E D. ORANGE 03.2023

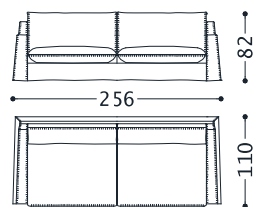

1TSLD3M

DREI SITZER MAXI SOFA

1TSLD3M		2THSD3M	
Cat.3	3.121,00	Cat.E	4.216,00
Cat.4	3.302,00	Cat.F	5.272,00
Cat.5	3.438,00	Cat.G	5.756,00
Cat.6	3.574,00	Cat.H	6.460,00
Cat.7	3.755,00	Cat.I	7.823,00
Cat.8	3.936,00	Cat.L	8.439,00
Cat.9	4.479,00	Cat.M	9.231,00
Cat.10	4.841,00		
Cat.11	5.248,00		
Cat.12	5.655,00		
Cat.13	6.153,00		

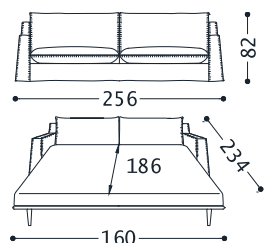

1TSLD3MEP

DREI SITZER MAXI SOFA MIT
ELEKTROGESCHWEISSTEM METALLROST
UND POLYURETHANMATRATZE

1TSLD3MEP		2THSD3MEP	
Cat.3	3.949,00	Cat.E	5.073,00
Cat.4	4.130,00	Cat.F	6.151,00
Cat.5	4.266,00	Cat.G	6.645,00
Cat.6	4.402,00	Cat.H	7.363,00
Cat.7	4.583,00	Cat.I	8.755,00
Cat.8	4.764,00	Cat.L	9.383,00
Cat.9	5.307,00	Cat.M	10.191,00
Cat.10	5.669,00		
Cat.11	6.076,00		
Cat.12	6.484,00		
Cat.13	6.982,00		

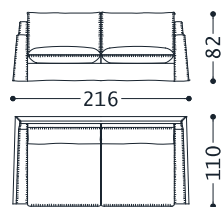

1TSLD3

DREI SITZER SOFA

1TSLD3		2THSD3	
Cat.3	2.796,00	Cat.E	3.812,00
Cat.4	2.961,00	Cat.F	4.728,00
Cat.5	3.085,00	Cat.G	5.148,00
Cat.6	3.209,00	Cat.H	5.759,00
Cat.7	3.374,00	Cat.I	6.942,00
Cat.8	3.539,00	Cat.L	7.476,00
Cat.9	4.034,00	Cat.M	8.164,00
Cat.10	4.364,00		
Cat.11	4.735,00		
Cat.12	5.107,00		
Cat.13	5.560,00		

07 S74 N/E D. ORANGE 03.2023

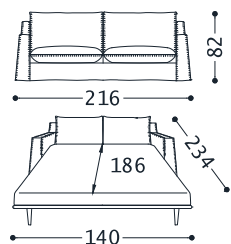

1TSLD3EP

DREI SITZER SOFA MIT
ELEKTROGESCHWEISSTEM METALLROST
UND POLYURETHANMATRATZE

1TSLD3EP		2THSD3EP	
Cat.3	3.581,00	Cat.E	4.563,00
Cat.4	3.746,00	Cat.F	5.501,00
Cat.5	3.869,00	Cat.G	5.931,00
Cat.6	3.993,00	Cat.H	6.556,00
Cat.7	4.158,00	Cat.I	7.768,00
Cat.8	4.323,00	Cat.L	8.315,00
Cat.9	4.818,00	Cat.M	9.018,00
Cat.10	5.148,00		
Cat.11	5.520,00		
Cat.12	5.891,00		
Cat.13	6.345,00		

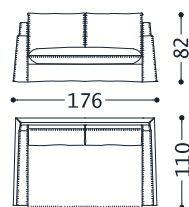

1TSLD2

ZWEI SITZER SOFA (EINZIGES SITZKISSEN)

1TSLD2		2THSD2	
Cat.3	2.397,00	Cat.E	3.235,00
Cat.4	2.559,00	Cat.F	4.012,00
Cat.5	2.682,00	Cat.G	4.368,00
Cat.6	2.804,00	Cat.H	4.885,00
Cat.7	2.967,00	Cat.I	5.888,00
Cat.8	3.129,00	Cat.L	6.341,00
Cat.9	3.618,00	Cat.M	6.923,00
Cat.10	3.944,00		
Cat.11	4.310,00		
Cat.12	4.677,00		
Cat.13	5.124,00		

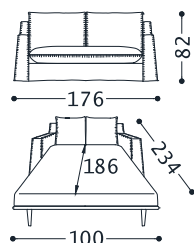

1TSLD2EP

ZWEI SITZER SOFA MIT
ELEKTROGESCHWEISSTEM METALLROST
UND POLYURETHANMATRATZE (EINZIGES
SITZKISSEN)

1TSLD2EP		2THSD2EP	
Cat.3	3.132,00	Cat.E	3.934,00
Cat.4	3.294,00	Cat.F	4.732,00
Cat.5	3.417,00	Cat.G	5.098,00
Cat.6	3.539,00	Cat.H	5.630,00
Cat.7	3.702,00	Cat.I	6.661,00
Cat.8	3.864,00	Cat.L	7.127,00
Cat.9	4.353,00	Cat.M	7.726,00
Cat.10	4.679,00		
Cat.11	5.045,00		
Cat.12	5.412,00		
Cat.13	5.859,00		

07 S74 N/E D. ORANGE 03.2023

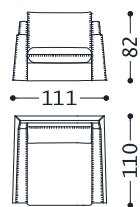

1TSLPL

LARGE SESSEL

1TSLPL		2THSPL	
Cat.3	1.791,00	Cat.E	2.343,00
Cat.4	1.896,00	Cat.F	2.913,00
Cat.5	1.974,00	Cat.G	3.174,00
Cat.6	2.053,00	Cat.H	3.553,00
Cat.7	2.158,00	Cat.I	4.288,00
Cat.8	2.262,00	Cat.L	4.621,00
Cat.9	2.576,00	Cat.M	5.047,00
Cat.10	2.786,00		
Cat.11	3.021,00		
Cat.12	3.257,00		
Cat.13	3.545,00		

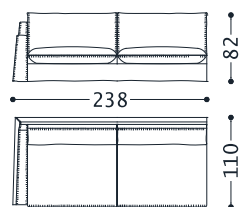

1TSLD3MSX

DREI SITZER MAXI SOFA ARMLEHNE LINKS
DREI SITZER MAXI SOFA ARMLEHNE
RECHTS

1TSLD3MSX		2THSD3MSX	
1TSLD3MDX		2THSD3MDX	
Cat.3	2.925,00	Cat.E	3.930,00
Cat.4	3.093,00	Cat.F	4.888,00
Cat.5	3.219,00	Cat.G	5.327,00
Cat.6	3.345,00	Cat.H	5.965,00
Cat.7	3.513,00	Cat.I	7.202,00
Cat.8	3.680,00	Cat.L	7.760,00
Cat.9	4.184,00	Cat.M	8.479,00
Cat.10	4.520,00		
Cat.11	4.898,00		
Cat.12	5.276,00		
Cat.13	5.738,00		

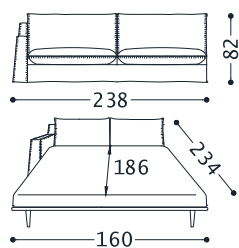

1TSLD3MSXEP

DREI SITZER MAXI SOFA ARMLEHNE LINKS
MIT ELEKTROGESCHWEISSTEM
METALLROST UND
POLYURETHANMATRATZE
DREI SITZER MAXI SOFA ARMLEHNE
RECHTS MIT ELEKTROGESCHWEISSTEM
METALLROST UND
POLYURETHANMATRATZE

1TSLD3MSXEP		2THSD3MSXEP	
1TSLD3MDXEP		2THSD3MDXEP	
Cat.3	3.624,00	Cat.E	4.667,00
Cat.4	3.792,00	Cat.F	5.647,00
Cat.5	3.918,00	Cat.G	6.096,00
Cat.6	4.044,00	Cat.H	6.748,00
Cat.7	4.212,00	Cat.I	8.013,00
Cat.8	4.379,00	Cat.L	8.585,00
Cat.9	4.883,00	Cat.M	9.319,00
Cat.10	5.219,00		
Cat.11	5.597,00		
Cat.12	5.975,00		
Cat.13	6.437,00		

07 S74 N/E D. ORANGE 03.2023

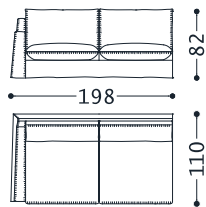

1TSLD3SX

DREI SITZER SOFA ARMLEHNE LINKS
DREI SITZER SOFA ARMLEHNE RECHTS

1TSLD3SX		2THSD3SX	
1TSLD3DX		2THSD3DX	
Cat.3	2.593,00	Cat.E	3.524,00
Cat.4	2.750,00	Cat.F	4.348,00
Cat.5	2.868,00	Cat.G	4.726,00
Cat.6	2.986,00	Cat.H	5.276,00
Cat.7	3.143,00	Cat.I	6.341,00
Cat.8	3.300,00	Cat.L	6.822,00
Cat.9	3.771,00	Cat.M	7.440,00
Cat.10	4.085,00		
Cat.11	4.439,00		
Cat.12	4.792,00		
Cat.13	5.224,00		

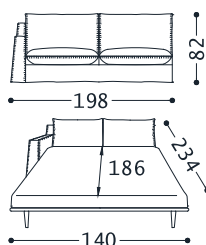

1TSLD3SXEP

DREI SITZER SOFA ARMLEHNE LINKS MIT
ELEKTROGESCHWEISSTEM METALLROST
UND POLYURETHANMATRATZE
DREI SITZER SOFA ARMLEHNE RECHTS MIT
ELEKTROGESCHWEISSTEM METALLROST
UND POLYURETHANMATRATZE

1TSLD3SXEP		2THSD3SXEP	
1TSLD3DXEP		2THSD3DXEP	
Cat.3	3.369,00	Cat.E	4.270,00
Cat.4	3.526,00	Cat.F	5.112,00
Cat.5	3.644,00	Cat.G	5.498,00
Cat.6	3.761,00	Cat.H	6.059,00
Cat.7	3.918,00	Cat.I	7.146,00
Cat.8	4.075,00	Cat.L	7.638,00
Cat.9	4.547,00	Cat.M	8.269,00
Cat.10	4.861,00		
Cat.11	5.214,00		
Cat.12	5.567,00		
Cat.13	5.999,00		

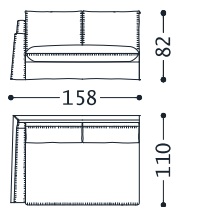

1TSLD2SX

ZWEI SITZER SOFA ARMLEHNE LINKS
(EINZIGES SITZKISSEN)
ZWEI SITZER SOFA ARMLEHNE RECHTS
(EINZIGES SITZKISSEN)

1TSLD2SX		2THSD2SX	
1TSLD2DX		2THSD2DX	
Cat.3	2.189,00	Cat.E	2.946,00
Cat.4	2.341,00	Cat.F	3.630,00
Cat.5	2.455,00	Cat.G	3.944,00
Cat.6	2.569,00	Cat.H	4.401,00
Cat.7	2.721,00	Cat.I	5.286,00
Cat.8	2.873,00	Cat.L	5.685,00
Cat.9	3.329,00	Cat.M	6.199,00
Cat.10	3.633,00		
Cat.11	3.975,00		
Cat.12	4.317,00		
Cat.13	4.735,00		

THEO SLIM

Wahrung: EUR

alberta
Made in Italy

07 S74 N/E D. ORANGE 03.2023

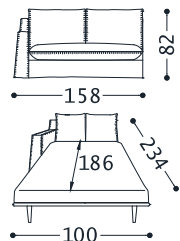

1TSLD2SXEP

ZWEI SITZER SOFA ARMLEHNE LINKS MIT ELEKTROGESCHWEISSTEM METALLROST UND POLYURETHANMATRATZE (EINZIGES SITZKISSEN)
ZWEI SITZER SOFA ARMLEHNE RECHTS MIT ELEKTROGESCHWEISSTEM METALLROST UND POLYURETHANMATRATZE (EINZIGES SITZKISSEN)

1TSLD2SXEP		2THSD2SXEP	
1TSLD2DXEP		2THSD2DXEP	
Cat.3	2.915,00	Cat.E	3.649,00
Cat.4	3.067,00	Cat.F	4.361,00
Cat.5	3.181,00	Cat.G	4.686,00
Cat.6	3.295,00	Cat.H	5.160,00
Cat.7	3.447,00	Cat.I	6.079,00
Cat.8	3.599,00	Cat.L	6.494,00
Cat.9	4.055,00	Cat.M	7.027,00
Cat.10	4.359,00		
Cat.11	4.701,00		
Cat.12	5.043,00		
Cat.13	5.461,00		

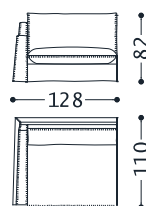

1TSLPMSX

MAXI SESSEL ARMLEHNE LINKS
MAXI SESSEL ARMLEHNE RECHTS

1TSLPMSX		2THSPMSX	
1TSLPMDX		2THSPMDX	
Cat.3	1.764,00	Cat.E	2.321,00
Cat.4	1.873,00	Cat.F	2.883,00
Cat.5	1.955,00	Cat.G	3.141,00
Cat.6	2.037,00	Cat.H	3.516,00
Cat.7	2.146,00	Cat.I	4.243,00
Cat.8	2.255,00	Cat.L	4.572,00
Cat.9	2.582,00	Cat.M	4.994,00
Cat.10	2.800,00		
Cat.11	3.046,00		
Cat.12	3.291,00		
Cat.13	3.591,00		

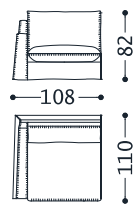

1TSLPSX

SESSEL ARMLEHNE LINKS
SESSEL ARMLEHNE RECHTS

1TSLPSX		2THSPSX	
1TSLPDX		2THSPDX	
Cat.3	1.530,00	Cat.E	2.015,00
Cat.4	1.626,00	Cat.F	2.504,00
Cat.5	1.697,00	Cat.G	2.727,00
Cat.6	1.769,00	Cat.H	3.053,00
Cat.7	1.865,00	Cat.I	3.684,00
Cat.8	1.961,00	Cat.L	3.969,00
Cat.9	2.249,00	Cat.M	4.336,00
Cat.10	2.441,00		
Cat.11	2.657,00		
Cat.12	2.873,00		
Cat.13	3.137,00		

07 S74 N/E D. ORANGE 03.2023

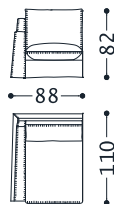

1TSLPSSX

SMALL SESSEL ARMLEHNE LINKS
SMALL SESSEL ARMLEHNE RECHTS

1TSLPSSX		2THSPSSX	
1TSLPSDX		2THSPSDX	
Cat.3	1.403,00	Cat.E	1.810,00
Cat.4	1.495,00	Cat.F	2.231,00
Cat.5	1.565,00	Cat.G	2.423,00
Cat.6	1.634,00	Cat.H	2.704,00
Cat.7	1.726,00	Cat.I	3.248,00
Cat.8	1.819,00	Cat.L	3.493,00
Cat.9	2.096,00	Cat.M	3.809,00
Cat.10	2.280,00		
Cat.11	2.488,00		
Cat.12	2.696,00		
Cat.13	2.950,00		

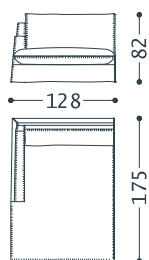

2THSDORMXSX

MAXI DORMEUSE ARMLEHNE LINKS
MAXI DORMEUSE ARMLEHNE RECHTS

2THSDORMXSX	
2THSDORMXDX	
Cat.E	3.279,00
Cat.F	4.003,00
Cat.G	4.335,00
Cat.H	4.817,00
Cat.I	5.753,00
Cat.L	6.175,00
Cat.M	6.718,00

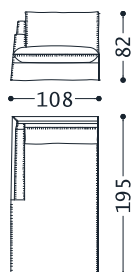

1TSLDORMSX

DORMEUSE ARMLEHNE LINKS
DORMEUSE ARMLEHNE RECHTS

1TSLDORMSX		2THSDORMSX	
1TSLDORMDX		2THSDORMDX	
Cat.3	2.216,00	Cat.E	2.974,00
Cat.4	2.345,00	Cat.F	3.650,00
Cat.5	2.442,00	Cat.G	3.960,00
Cat.6	2.539,00	Cat.H	4.411,00
Cat.7	2.669,00	Cat.I	5.284,00
Cat.8	2.798,00	Cat.L	5.679,00
Cat.9	3.186,00	Cat.M	6.186,00
Cat.10	3.445,00		
Cat.11	3.736,00		
Cat.12	4.028,00		
Cat.13	4.384,00		

07 S74 N/E D. ORANGE 03.2023

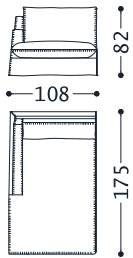

1TSLDORSSX

SMALL DORMEUSE ARMLEHNE LINKS
SMALL DORMEUSE ARMLEHNE RECHTS

1TSLDORSSX		2THSDORSSX	
1TSLDORSDX		2THSDORSDX	
Cat.3	2.227,00	Cat.E	2.935,00
Cat.4	2.353,00	Cat.F	3.569,00
Cat.5	2.448,00	Cat.G	3.860,00
Cat.6	2.543,00	Cat.H	4.283,00
Cat.7	2.670,00	Cat.I	5.103,00
Cat.8	2.796,00	Cat.L	5.473,00
Cat.9	3.176,00	Cat.M	5.949,00
Cat.10	3.429,00		
Cat.11	3.713,00		
Cat.12	3.998,00		
Cat.13	4.346,00		

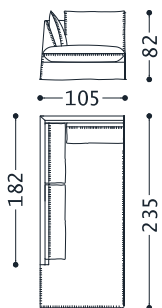

1TSLMERSX

MERIDIENNE LINKS
MERIDIENNE RECHTS

1TSLMERSX		2THSMERSX	
1TSLMERDX		2THSMERDX	
Cat.3	2.917,00	Cat.E	3.845,00
Cat.4	3.111,00	Cat.F	4.763,00
Cat.5	3.256,00	Cat.G	5.184,00
Cat.6	3.401,00	Cat.H	5.796,00
Cat.7	3.594,00	Cat.I	6.982,00
Cat.8	3.788,00	Cat.L	7.518,00
Cat.9	4.368,00	Cat.M	8.206,00
Cat.10	4.755,00		
Cat.11	5.190,00		
Cat.12	5.625,00		
Cat.13	6.157,00		

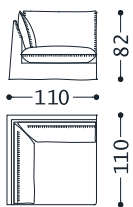

1TSLAR

ECKELEMMENT

1TSLAR		2THSAR	
Cat.3	2.023,00	Cat.E	2.604,00
Cat.4	2.144,00	Cat.F	3.179,00
Cat.5	2.235,00	Cat.G	3.443,00
Cat.6	2.326,00	Cat.H	3.827,00
Cat.7	2.448,00	Cat.I	4.571,00
Cat.8	2.569,00	Cat.L	4.907,00
Cat.9	2.933,00	Cat.M	5.339,00
Cat.10	3.176,00		
Cat.11	3.449,00		
Cat.12	3.723,00		
Cat.13	4.057,00		

07 S74 N/E D. ORANGE 03.2023

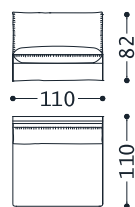

1TSLPM1

MAXI ZENTRAL SESSEL

1TSLPM1		2THSPM1	
Cat.3	1.483,00	Cat.E	1.934,00
Cat.4	1.580,00	Cat.F	2.401,00
Cat.5	1.652,00	Cat.G	2.615,00
Cat.6	1.725,00	Cat.H	2.926,00
Cat.7	1.821,00	Cat.I	3.529,00
Cat.8	1.918,00	Cat.L	3.801,00
Cat.9	2.208,00	Cat.M	4.151,00
Cat.10	2.401,00		
Cat.11	2.619,00		
Cat.12	2.837,00		
Cat.13	3.103,00		

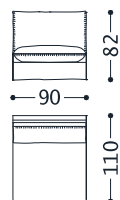

1TSLP1

ZENTRAL SESSEL

1TSLP1		2THSP1	
Cat.3	1.364,00	Cat.E	1.758,00
Cat.4	1.450,00	Cat.F	2.157,00
Cat.5	1.514,00	Cat.G	2.340,00
Cat.6	1.579,00	Cat.H	2.606,00
Cat.7	1.664,00	Cat.I	3.122,00
Cat.8	1.750,00	Cat.L	3.354,00
Cat.9	2.008,00	Cat.M	3.654,00
Cat.10	2.179,00		
Cat.11	2.372,00		
Cat.12	2.565,00		
Cat.13	2.801,00		

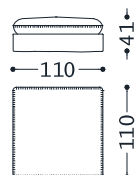

1TSLPFFQ

QUADRATISCHER HOCKER

1TSLPFFQ		2THSPFFQ	
Cat.3	1.140,00	Cat.E	1.450,00
Cat.4	1.201,00	Cat.F	1.798,00
Cat.5	1.247,00	Cat.G	1.958,00
Cat.6	1.293,00	Cat.H	2.191,00
Cat.7	1.354,00	Cat.I	2.642,00
Cat.8	1.415,00	Cat.L	2.845,00
Cat.9	1.598,00	Cat.M	3.107,00
Cat.10	1.720,00		
Cat.11	1.858,00		
Cat.12	1.995,00		
Cat.13	2.163,00		

07 S74 N/E D. ORANGE 03.2023

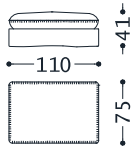

RECHTECKIGER HOCKER

1TSLPFFR

1TSLPFFR		2THSPFFR	
Cat.3	1.091,00	Cat.E	1.400,00
Cat.4	1.152,00	Cat.F	1.749,00
Cat.5	1.198,00	Cat.G	1.909,00
Cat.6	1.244,00	Cat.H	2.142,00
Cat.7	1.305,00	Cat.I	2.593,00
Cat.8	1.366,00	Cat.L	2.796,00
Cat.9	1.549,00	Cat.M	3.058,00
Cat.10	1.671,00		
Cat.11	1.809,00		
Cat.12	1.946,00		
Cat.13	2.114,00		

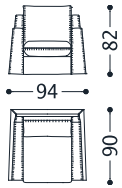

SMALL SESSEL

1TSLPC

1TSLPC		2THSPC	
Cat.3	1.300,00	Cat.E	1.591,00
Cat.4	1.390,00	Cat.F	1.931,00
Cat.5	1.457,00	Cat.G	2.087,00
Cat.6	1.525,00	Cat.H	2.314,00
Cat.7	1.615,00	Cat.I	2.754,00
Cat.8	1.705,00	Cat.L	2.952,00
Cat.9	1.976,00	Cat.M	3.207,00
Cat.10	2.156,00		
Cat.11	2.359,00		
Cat.12	2.562,00		
Cat.13	2.810,00		

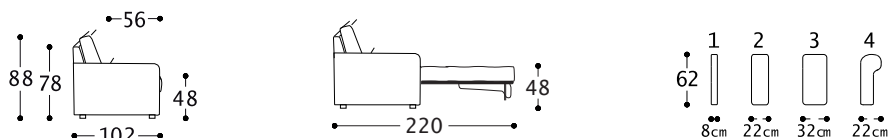

07 S74 N/E D. ORANGE 03.2023

BEZÜGE SIND ABNEHMBAR. DIESES MODELL KANN MIT UNTERSCHIEDLICHEN STOFFE FUER RUECK-SITZKISSEN UND CHASSIS BEZOGEN WERDEN. SITZ UND RÜCKENKISSEN WERDEN MIT DEM SELBEN STOFF BEZOGEN. STOFFE MIT MUSTERN EIGNEN SICH NICHT FÜR DIESES MODELL. LIEFERBAR AUCH AUS KUNSTLEDER (NICHT ABNEHMBAR). SCHLAFSOFAS SIND MIT POLYURETHANSCHAUM MATRATZE GELIEFERT, H. 12 CM. AUF ANFRAGE KANN MAN AUCH MIT MATRATZE "LUX" MIT MEMORY-SCHAUM UND ABNEHMBAR STRETCH STOFF GELIEFERT WERDEN. DIES HAT FOLGENDE AUFSCHLÄGE AUF DER PREISLISTE: MA10108: 200X160X12 EUR. 488,00 - MA10107: 200X140X12 EUR. 438,00 - MA10106: 200X120X12 EUR. 387,00. DAS MODELL IST MIT BOX FÜR KISSEN VERSEHEN. ACHTUNG: DIE ELEMENTE MIT BETT WERDEN MIT NYLON VERPACKT, ZERLEGT GELIEFERT UND IN 3 KOLLI GETEILT: SOFA MIT METALLROST, MATRATZE UND ARMLEHENEN.

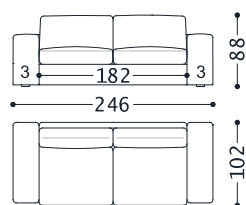

0TOGC1

1 ARMLEHNE RECHTS 3
1 ARMLEHNE LINKS 3
1 ZENTRAL DREI SITZER SOFA MIT
ELEKTROGESCHWEISSTEM METALLROST
UND POLYURETHANSCHAUM MATRATZE

0TOGC1

Cat.3	3.094,00
Cat.4	3.240,00
Cat.5	3.348,00
Cat.6	3.459,00
Cat.7	3.603,00
Cat.8	3.749,00
Cat.9	4.186,00
Cat.10	4.477,00
Cat.11	4.804,00
Cat.12	5.131,00
Cat.13	5.532,00

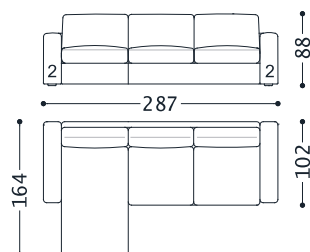

0TOGC2

1 ARMLEHNE RECHTS 2
1 ARMLEHNE LINKS 2
1 ZENTRAL DORMEUSE MIT KASTEN
1 ZENTRAL ZWEI SITZER MAXI SOFA MIT
ELEKTROGESCHWEISSTEM METALLROST
UND POLYURETHANSCHAUM MATRATZE

0TOGC2

Cat.3	4.344,00
Cat.4	4.559,00
Cat.5	4.719,00
Cat.6	4.880,00
Cat.7	5.092,00
Cat.8	5.306,00
Cat.9	5.947,00
Cat.10	6.376,00
Cat.11	6.855,00
Cat.12	7.337,00
Cat.13	7.925,00

07 S74 N/E D. ORANGE 03.2023

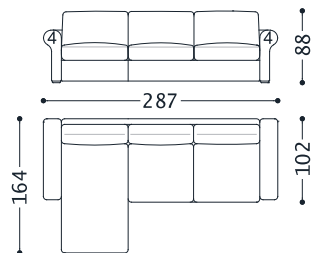

0TOGC3

1 ARMLEHNE RECHTS 4
1 ARMLEHNE LINKS 4
1 ZENTRAL DORMEUSE
1 ZENTRAL ZWEI SITZER MAXI SOFA MIT
ELEKTROGESCHWEISSTEM METALLROST
UND POLYURETHANSCHAUM MATRATZE

0TOGC3

Cat.3	4.191,00
Cat.4	4.409,00
Cat.5	4.574,00
Cat.6	4.738,00
Cat.7	4.958,00
Cat.8	5.177,00
Cat.9	5.835,00
Cat.10	6.274,00
Cat.11	6.769,00
Cat.12	7.262,00
Cat.13	7.865,00

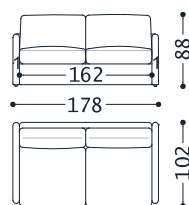

0TOGC4

1 ARMLEHNE RECHTS 1
1 ARMLEHNE LINKS 1
1 ZENTRAL ZWEI SITZER MAXI SOFA MIT
ELEKTROGESCHWEISSTEM METALLROST
UND POLYURETHANSCHAUM MATRATZE

0TOGC4

Cat.3	2.779,00
Cat.4	2.913,00
Cat.5	3.015,00
Cat.6	3.116,00
Cat.7	3.250,00
Cat.8	3.385,00
Cat.9	3.789,00
Cat.10	4.060,00
Cat.11	4.364,00
Cat.12	4.668,00
Cat.13	5.037,00

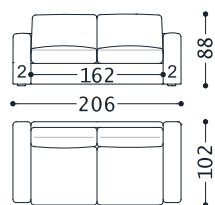

0TOGC5

1 ARMLEHNE RECHTS 2
1 ARMLEHNE LINKS 2
1 ZENTRAL ZWEI SITZER MAXI SOFA MIT
ELEKTROGESCHWEISSTEM METALLROST
UND POLYURETHANSCHAUM MATRATZE

0TOGC5

Cat.3	2.823,00
Cat.4	2.963,00
Cat.5	3.067,00
Cat.6	3.172,00
Cat.7	3.310,00
Cat.8	3.449,00
Cat.9	3.867,00
Cat.10	4.146,00
Cat.11	4.458,00
Cat.12	4.772,00
Cat.13	5.155,00

07 S74 N/E D. ORANGE 03.2023

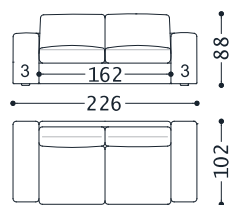

0TOGC6

1 ARMLEHNE RECHTS 3
1 ARMLEHNE LINKS 3
1 ZENTRAL ZWEI SITZER MAXI SOFA MIT
ELEKTROGESCHWEISSTEM METALLROST
UND POLYURETHANSCHAUM MATRATZE

0TOGC6

Cat.3	2.863,00
Cat.4	3.007,00
Cat.5	3.113,00
Cat.6	3.222,00
Cat.7	3.364,00
Cat.8	3.509,00
Cat.9	3.939,00
Cat.10	4.226,00
Cat.11	4.548,00
Cat.12	4.870,00
Cat.13	5.265,00

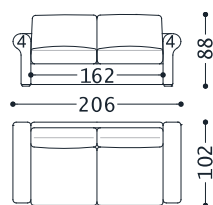

0TOGC7

1 ARMLEHNE RECHTS 4
1 ARMLEHNE LINKS 4
1 ZENTRAL ZWEI SITZER MAXI SOFA MIT
ELEKTROGESCHWEISSTEM METALLROST
UND POLYURETHANSCHAUM MATRATZE

0TOGC7

Cat.3	2.855,00
Cat.4	2.997,00
Cat.5	3.105,00
Cat.6	3.212,00
Cat.7	3.356,00
Cat.8	3.499,00
Cat.9	3.929,00
Cat.10	4.216,00
Cat.11	4.540,00
Cat.12	4.862,00
Cat.13	5.257,00

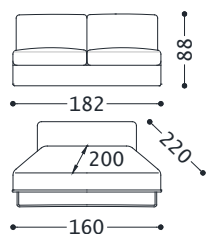

1TOGD31EP

ZENTRAL DREI SITZER SOFA MIT
ELEKTROGESCHWEISSTEM METALLROST
UND POLYURETHANSCHAUM MATRATZE

1TOGD31EP

Cat.3	2.648,00
Cat.4	2.752,00
Cat.5	2.830,00
Cat.6	2.909,00
Cat.7	3.013,00
Cat.8	3.117,00
Cat.9	3.430,00
Cat.10	3.639,00
Cat.11	3.874,00
Cat.12	4.109,00
Cat.13	4.396,00

07 S74 N/E D. ORANGE 03.2023

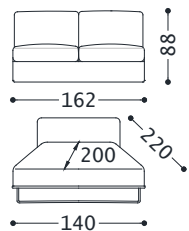

1TOGD2M1EP

ZENTRAL ZWEI SITZER MAXI SOFA MIT
ELEKTROGESCHWEISSTEM METALLROST
UND POLYURETHANSCHAUM MATRATZE

1TOGD2M1EP

Cat.3	2.417,00
Cat.4	2.519,00
Cat.5	2.595,00
Cat.6	2.672,00
Cat.7	2.774,00
Cat.8	2.877,00
Cat.9	3.183,00
Cat.10	3.388,00
Cat.11	3.618,00
Cat.12	3.848,00
Cat.13	4.129,00

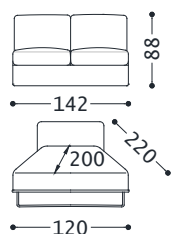

1TOGD21EP

ZENTRAL ZWEI SITZER SOFA MIT
ELEKTROGESCHWEISSTEM METALLROST
UND POLYURETHANSCHAUM MATRATZE

1TOGD21EP

Cat.3	2.316,00
Cat.4	2.417,00
Cat.5	2.492,00
Cat.6	2.567,00
Cat.7	2.667,00
Cat.8	2.767,00
Cat.9	3.067,00
Cat.10	3.267,00
Cat.11	3.493,00
Cat.12	3.718,00
Cat.13	3.993,00

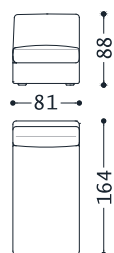

1TOGDORM1

ZENTRAL DORMEUSE

1TOGDORM1

Cat.3	1.336,00
Cat.4	1.412,00
Cat.5	1.469,00
Cat.6	1.526,00
Cat.7	1.602,00
Cat.8	1.678,00
Cat.9	1.906,00
Cat.10	2.058,00
Cat.11	2.229,00
Cat.12	2.400,00
Cat.13	2.608,00

07 S74 N/E D. ORANGE 03.2023

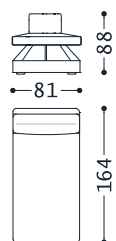

1TOGDORMC1

ZENTRAL DORMEUSE MIT KASTEN

1TOGDORMC1

Cat.3	1.521,00
Cat.4	1.596,00
Cat.5	1.652,00
Cat.6	1.708,00
Cat.7	1.782,00
Cat.8	1.857,00
Cat.9	2.080,00
Cat.10	2.230,00
Cat.11	2.397,00
Cat.12	2.565,00
Cat.13	2.770,00

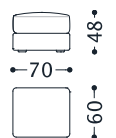

1TOGPFFR

RECHTECKIGER HOCKER

1TOGPFFR

Cat.3	581,00
Cat.4	626,00
Cat.5	659,00
Cat.6	693,00
Cat.7	738,00
Cat.8	782,00
Cat.9	917,00
Cat.10	1.006,00
Cat.11	1.107,00
Cat.12	1.207,00
Cat.13	1.330,00



1TOGPT

KOPFLEHNE

1TOGPT

Cat.3	105,00
Cat.4	118,00
Cat.5	128,00
Cat.6	137,00
Cat.7	150,00
Cat.8	163,00
Cat.9	201,00
Cat.10	227,00
Cat.11	256,00
Cat.12	284,00
Cat.13	320,00

07 S74 N/E D. ORANGE 03.2023

<p>1</p>  <p>8cm</p> <p>1TOGBRSX1</p>	<p>ARMLEHNE LINKS 1 ARMLEHNE RECHTS 1</p>	1TOGBRSX1	
		1TOGBRDY1	
		Cat.3	181,00
		Cat.4	197,00
		Cat.5	210,00
		Cat.6	222,00
		Cat.7	238,00
		Cat.8	254,00
		Cat.9	303,00
		Cat.10	336,00
		Cat.11	373,00
		Cat.12	410,00
		Cat.13	454,00

<p>2</p>  <p>22cm</p> <p>1TOGBRSX2</p>	<p>ARMLEHNE LINKS 2 ARMLEHNE RECHTS 2</p>	1TOGBRSX2	
		1TOGBRDY2	
		Cat.3	203,00
		Cat.4	222,00
		Cat.5	236,00
		Cat.6	250,00
		Cat.7	268,00
		Cat.8	286,00
		Cat.9	342,00
		Cat.10	379,00
		Cat.11	420,00
		Cat.12	462,00
		Cat.13	513,00

<p>3</p>  <p>32cm</p> <p>1TOGBRSX3</p>	<p>ARMLEHNE LINKS 3 ARMLEHNE RECHTS 3</p>	1TOGBRSX3	
		1TOGBRDY3	
		Cat.3	223,00
		Cat.4	244,00
		Cat.5	259,00
		Cat.6	275,00
		Cat.7	295,00
		Cat.8	316,00
		Cat.9	378,00
		Cat.10	419,00
		Cat.11	465,00
		Cat.12	511,00
		Cat.13	568,00

07 S74 N/E D. ORANGE 03.2023



1TOGBRSX4

ARMLEHNE LINKS 4
ARMLEHNE RECHTS 4

1TOGBRSX4	
1TOGBRDX4	
Cat.3	219,00
Cat.4	239,00
Cat.5	255,00
Cat.6	270,00
Cat.7	291,00
Cat.8	311,00
Cat.9	373,00
Cat.10	414,00
Cat.11	461,00
Cat.12	507,00
Cat.13	564,00

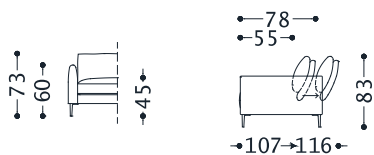

07 S74 N/E D. ORANGE 03.2023

DIE STOFF-VERSION IST ABNEHMBAR UND MAN KANN SITZUNG, CHASSIS UND RÜCKENKISSEN MIT UNTERSCHIEDLICHEN STOFFEN BEZIEHEN. LIEFERBAR AUCH AUS KUNSTLEDER (NICHT ABNEHMBAR). RÜCKENLEHNE MIT ABGLEITENDEM MECHANISMUS. STANDARD FUSS aus poliertem Aluminium, h. 15 cm (Cod. PD10375). OPTIONELLE FUSS aus lackiertem braunen Aluminium, h. 15 cm (Cod. PD10376).

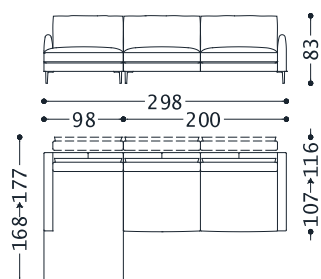

01VEGC1

1 DORMEUSE ARMLEHNE LINKS
1 DREI SITZER SOFA ARMLEHNE RECHTS

01VEGC1		02VEGC1	
Cat.3	4.748,00	Cat.E	5.985,00
Cat.4	4.998,00	Cat.F	7.207,00
Cat.5	5.185,00	Cat.G	7.766,00
Cat.6	5.372,00	Cat.H	8.581,00
Cat.7	5.621,00	Cat.I	10.158,00
Cat.8	5.870,00	Cat.L	10.870,00
Cat.9	6.618,00	Cat.M	11.787,00
Cat.10	7.117,00		
Cat.11	7.677,00		
Cat.12	8.237,00		
Cat.13	8.923,00		

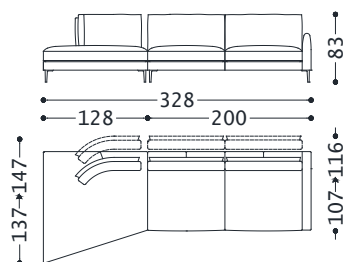

01VEGC2

1 DREI SITZER SOFA ARMLEHNE RECHTS
1 SPEZIELL LINKS ENDELEMENT

01VEGC2		02VEGC2	
Cat.3	4.781,00	Cat.E	6.056,00
Cat.4	5.030,00	Cat.F	7.313,00
Cat.5	5.217,00	Cat.G	7.889,00
Cat.6	5.404,00	Cat.H	8.728,00
Cat.7	5.653,00	Cat.I	10.352,00
Cat.8	5.903,00	Cat.L	11.086,00
Cat.9	6.650,00	Cat.M	12.029,00
Cat.10	7.149,00		
Cat.11	7.709,00		
Cat.12	8.270,00		
Cat.13	8.956,00		

07 S74 N/E D. ORANGE 03.2023

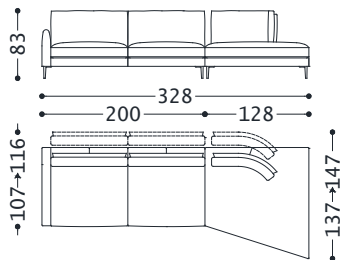

01VEGC7

1 DREI SITZER SOFA ARMLEHNE LINKS
1 SPEZIELL RECHTS ENDELEMENT

01VEGC7	
Cat.3	4.781,00
Cat.4	5.030,00
Cat.5	5.217,00
Cat.6	5.404,00
Cat.7	5.653,00
Cat.8	5.903,00
Cat.9	6.650,00
Cat.10	7.149,00
Cat.11	7.709,00
Cat.12	8.270,00
Cat.13	8.956,00

02VEGC7	
Cat.E	6.056,00
Cat.F	7.313,00
Cat.G	7.889,00
Cat.H	8.728,00
Cat.I	10.352,00
Cat.L	11.086,00
Cat.M	12.029,00

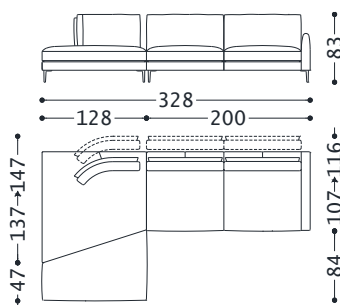

01VEGC4

1 DREI SITZER SOFA ARMLEHNE RECHTS
1 HOCKER FÜR ENDELEMENT ARMLEHNE
LINKS
1 SPEZIELL LINKS ENDELEMENT

01VEGC4	
Cat.3	5.945,00
Cat.4	6.232,00
Cat.5	6.448,00
Cat.6	6.663,00
Cat.7	6.951,00
Cat.8	7.239,00
Cat.9	8.101,00
Cat.10	8.677,00
Cat.11	9.323,00
Cat.12	9.970,00
Cat.13	10.762,00

02VEGC4	
Cat.E	7.488,00
Cat.F	8.984,00
Cat.G	9.670,00
Cat.H	10.668,00
Cat.I	12.601,00
Cat.L	13.474,00
Cat.M	14.597,00

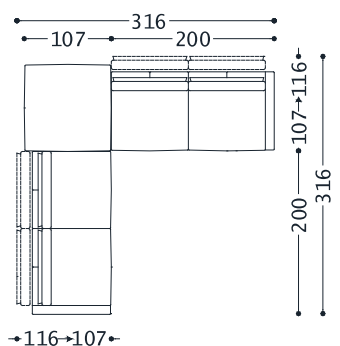

01VEGC5

1 DREI SITZER SOFA ARMLEHNE RECHTS
1 DREI SITZER SOFA ARMLEHNE LINKS
1 QUADRATISCHER HOCKER

01VEGC5	
Cat.3	6.627,00
Cat.4	6.990,00
Cat.5	7.261,00
Cat.6	7.533,00
Cat.7	7.895,00
Cat.8	8.258,00
Cat.9	9.343,00
Cat.10	10.068,00
Cat.11	10.883,00
Cat.12	11.697,00
Cat.13	12.693,00

02VEGC5	
Cat.E	8.275,00
Cat.F	9.964,00
Cat.G	10.738,00
Cat.H	11.865,00
Cat.I	14.046,00
Cat.L	15.031,00
Cat.M	16.298,00

07 S74 N/E D. ORANGE 03.2023

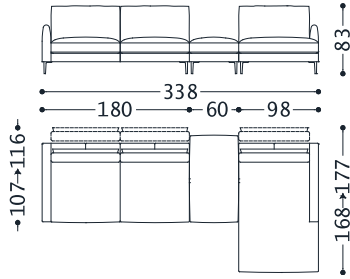

01VEGC6

1 DORMEUSE ARMLEHNE RECHTS
1 ZWEI SITZER MAXI SOFA ARMLEHNE
LINKS
1 RECHTECKIGER HOCKER

01VEGC6		02VEGC6	
Cat.3	5.452,00	Cat.E	6.956,00
Cat.4	5.723,00	Cat.F	8.387,00
Cat.5	5.926,00	Cat.G	9.042,00
Cat.6	6.128,00	Cat.H	9.997,00
Cat.7	6.399,00	Cat.I	11.844,00
Cat.8	6.669,00	Cat.L	12.678,00
Cat.9	7.481,00	Cat.M	13.752,00
Cat.10	8.023,00		
Cat.11	8.631,00		
Cat.12	9.238,00		
Cat.13	9.983,00		

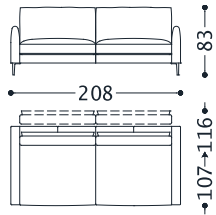

1VEGD3

DREI SITZER SOFA

1VEGD3		2VEGD3	
Cat.3	2.852,00	Cat.E	3.669,00
Cat.4	3.017,00	Cat.F	4.466,00
Cat.5	3.142,00	Cat.G	4.831,00
Cat.6	3.266,00	Cat.H	5.362,00
Cat.7	3.431,00	Cat.I	6.391,00
Cat.8	3.596,00	Cat.L	6.856,00
Cat.9	4.093,00	Cat.M	7.453,00
Cat.10	4.424,00		
Cat.11	4.796,00		
Cat.12	5.168,00		
Cat.13	5.623,00		

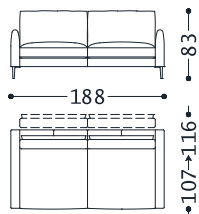

1VEGD2M

ZWEI SITZER MAXI SOFA

1VEGD2M		2VEGD2M	
Cat.3	2.601,00	Cat.E	3.365,00
Cat.4	2.749,00	Cat.F	4.106,00
Cat.5	2.861,00	Cat.G	4.445,00
Cat.6	2.972,00	Cat.H	4.939,00
Cat.7	3.120,00	Cat.I	5.896,00
Cat.8	3.269,00	Cat.L	6.328,00
Cat.9	3.714,00	Cat.M	6.884,00
Cat.10	4.011,00		
Cat.11	4.344,00		
Cat.12	4.678,00		
Cat.13	5.086,00		

07 S74 N/E D. ORANGE 03.2023

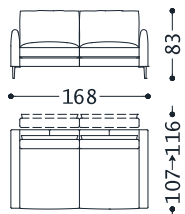

1VEGD2

ZWEI SITZER SOFA

1VEGD2		2VEGD2	
Cat.3	2.503,00	Cat.E	3.198,00
Cat.4	2.650,00	Cat.F	3.892,00
Cat.5	2.760,00	Cat.G	4.210,00
Cat.6	2.871,00	Cat.H	4.672,00
Cat.7	3.018,00	Cat.I	5.568,00
Cat.8	3.165,00	Cat.L	5.973,00
Cat.9	3.605,00	Cat.M	6.493,00
Cat.10	3.899,00		
Cat.11	4.230,00		
Cat.12	4.561,00		
Cat.13	4.965,00		

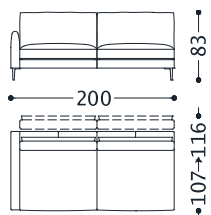

1VEGD3SX

DREI SITZER SOFA ARMLEHNE LINKS
DREI SITZER SOFA ARMLEHNE RECHTS

1VEGD3SX		2VEGD3SX	
1VEGD3DX		2VEGD3DX	
Cat.3	2.745,00	Cat.E	3.439,00
Cat.4	2.900,00	Cat.F	4.164,00
Cat.5	3.016,00	Cat.G	4.496,00
Cat.6	3.132,00	Cat.H	4.980,00
Cat.7	3.287,00	Cat.I	5.916,00
Cat.8	3.442,00	Cat.L	6.339,00
Cat.9	3.906,00	Cat.M	6.883,00
Cat.10	4.216,00		
Cat.11	4.564,00		
Cat.12	4.912,00		
Cat.13	5.338,00		

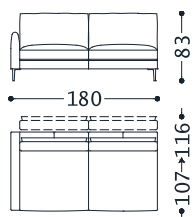

1VEGD2MSX

ZWEI SITZER MAXI SOFA ARMLEHNE LINKS
ZWEI SITZER MAXI SOFA ARMLEHNE RECHTS

1VEGD2MSX		2VEGD2MSX	
1VEGD2MDX		2VEGD2MDX	
Cat.3	2.496,00	Cat.E	3.169,00
Cat.4	2.634,00	Cat.F	3.864,00
Cat.5	2.737,00	Cat.G	4.183,00
Cat.6	2.840,00	Cat.H	4.647,00
Cat.7	2.978,00	Cat.I	5.545,00
Cat.8	3.116,00	Cat.L	5.950,00
Cat.9	3.529,00	Cat.M	6.472,00
Cat.10	3.805,00		
Cat.11	4.115,00		
Cat.12	4.424,00		
Cat.13	4.803,00		

07 S74 N/E D. ORANGE 03.2023

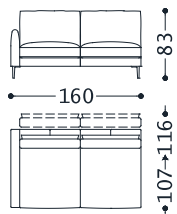

1VEGD2SX

ZWEI SITZER SOFA ARMLEHNE LINKS
ZWEI SITZER SOFA ARMLEHNE RECHTS

1VEGD2SX		2VEGD2SX	
1VEGD2DX		2VEGD2DX	
Cat.3	2.400,00	Cat.E	2.980,00
Cat.4	2.536,00	Cat.F	3.604,00
Cat.5	2.638,00	Cat.G	3.890,00
Cat.6	2.741,00	Cat.H	4.306,00
Cat.7	2.877,00	Cat.I	5.112,00
Cat.8	3.013,00	Cat.L	5.476,00
Cat.9	3.422,00	Cat.M	5.944,00
Cat.10	3.695,00		
Cat.11	4.002,00		
Cat.12	4.308,00		
Cat.13	4.683,00		

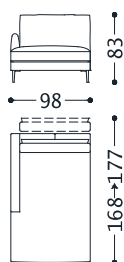

1VEGDORMSX

DORMEUSE ARMLEHNE LINKS
DORMEUSE ARMLEHNE RECHTS

1VEGDORMSX		2VEGDORMSX	
1VEGDORMDX		2VEGDORMDX	
Cat.3	2.003,00	Cat.E	2.546,00
Cat.4	2.098,00	Cat.F	3.043,00
Cat.5	2.169,00	Cat.G	3.270,00
Cat.6	2.240,00	Cat.H	3.601,00
Cat.7	2.334,00	Cat.I	4.242,00
Cat.8	2.428,00	Cat.L	4.531,00
Cat.9	2.712,00	Cat.M	4.904,00
Cat.10	2.901,00		
Cat.11	3.113,00		
Cat.12	3.325,00		
Cat.13	3.585,00		

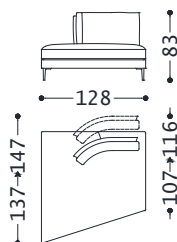

1VEGTRSPSX

SPEZIELL LINKS ENDELEMENT
SPEZIELL RECHTS ENDELEMENT

1VEGTRSPSX		2VEGTRSPSX	
1VEGTRSPDX		2VEGTRSPDX	
Cat.3	2.036,00	Cat.E	2.617,00
Cat.4	2.130,00	Cat.F	3.149,00
Cat.5	2.201,00	Cat.G	3.393,00
Cat.6	2.272,00	Cat.H	3.748,00
Cat.7	2.366,00	Cat.I	4.436,00
Cat.8	2.461,00	Cat.L	4.747,00
Cat.9	2.744,00	Cat.M	5.146,00
Cat.10	2.933,00		
Cat.11	3.145,00		
Cat.12	3.358,00		
Cat.13	3.618,00		

07 S74 N/E D. ORANGE 03.2023

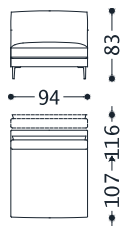

ZENTRAL LARGE SESSEL

1VEGPL1

1VEGPL1		2VEGPL1	
Cat.3	1.472,00	Cat.E	2.069,00
Cat.4	1.554,00	Cat.F	2.520,00
Cat.5	1.616,00	Cat.G	2.727,00
Cat.6	1.678,00	Cat.H	3.028,00
Cat.7	1.760,00	Cat.I	3.611,00
Cat.8	1.842,00	Cat.L	3.875,00
Cat.9	2.089,00	Cat.M	4.213,00
Cat.10	2.254,00		
Cat.11	2.439,00		
Cat.12	2.625,00		
Cat.13	2.851,00		

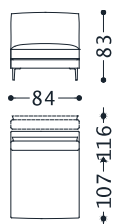

MAXI ZENTRAL SESSEL

1VEGPM1

1VEGPM1		2VEGPM1	
Cat.3	1.420,00	Cat.E	1.862,00
Cat.4	1.501,00	Cat.F	2.290,00
Cat.5	1.562,00	Cat.G	2.486,00
Cat.6	1.623,00	Cat.H	2.770,00
Cat.7	1.704,00	Cat.I	3.322,00
Cat.8	1.785,00	Cat.L	3.572,00
Cat.9	2.028,00	Cat.M	3.892,00
Cat.10	2.189,00		
Cat.11	2.372,00		
Cat.12	2.554,00		
Cat.13	2.776,00		

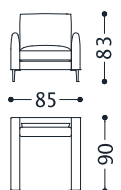

SESSEL (OHNE MECHANISMUS)

1VEGPSM

1VEGPSM		2VEGPSM	
Cat.3	1.411,00	Cat.E	1.871,00
Cat.4	1.485,00	Cat.F	2.310,00
Cat.5	1.540,00	Cat.G	2.511,00
Cat.6	1.596,00	Cat.H	2.804,00
Cat.7	1.669,00	Cat.I	3.371,00
Cat.8	1.743,00	Cat.L	3.627,00
Cat.9	1.965,00	Cat.M	3.957,00
Cat.10	2.112,00		
Cat.11	2.279,00		
Cat.12	2.445,00		
Cat.13	2.648,00		

07 S74 N/E D. ORANGE 03.2023

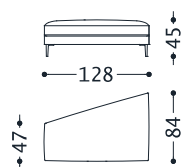

1VEGPFFTSX

HOCKER FUR ENDELEMENT ARMLEHNE
LINKS
HOCKER FUR ENDELEMENT ARMLEHNE
RECHTS

1VEGPFFTSX		2VEGPFFTSX	
1VEGPFFTDX		2VEGPFFTDX	
Cat.3	1.164,00	Cat.E	1.432,00
Cat.4	1.202,00	Cat.F	1.671,00
Cat.5	1.231,00	Cat.G	1.781,00
Cat.6	1.259,00	Cat.H	1.940,00
Cat.7	1.298,00	Cat.I	2.249,00
Cat.8	1.336,00	Cat.L	2.388,00
Cat.9	1.451,00	Cat.M	2.568,00
Cat.10	1.528,00		
Cat.11	1.614,00		
Cat.12	1.700,00		
Cat.13	1.806,00		

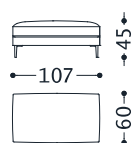

1VEGPFFR

RECHTECKIGER HOCKER

1VEGPFFR		2VEGPFFR	
Cat.3	953,00	Cat.E	1.241,00
Cat.4	991,00	Cat.F	1.480,00
Cat.5	1.020,00	Cat.G	1.589,00
Cat.6	1.048,00	Cat.H	1.749,00
Cat.7	1.087,00	Cat.I	2.057,00
Cat.8	1.125,00	Cat.L	2.197,00
Cat.9	1.240,00	Cat.M	2.376,00
Cat.10	1.317,00		
Cat.11	1.403,00		
Cat.12	1.489,00		
Cat.13	1.595,00		

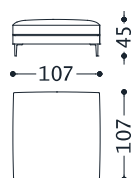

1VEGPFFQ

QUADRATISCHER HOCKER

1VEGPFFQ		2VEGPFFQ	
Cat.3	1.137,00	Cat.E	1.397,00
Cat.4	1.190,00	Cat.F	1.636,00
Cat.5	1.229,00	Cat.G	1.746,00
Cat.6	1.269,00	Cat.H	1.905,00
Cat.7	1.321,00	Cat.I	2.214,00
Cat.8	1.374,00	Cat.L	2.353,00
Cat.9	1.531,00	Cat.M	2.532,00
Cat.10	1.636,00		
Cat.11	1.755,00		
Cat.12	1.873,00		
Cat.13	2.017,00		

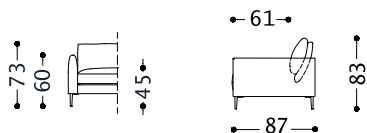

07 S74 N/E D. ORANGE 03.2023

RÜCKENLEHNE OHNE ABGLEITENDEM MECHANISMUS (Siehe Mod. VEGA). DIE STOFF-VERSION IST ABNEHMBAR UND MAN KANN SITZUNG, CHASSIS UND RÜCKENKISSEN MIT UNTERSCHIEDLICHEN STOFFEN BEZIEHEN. LIEFERBAR AUCH AUS KUNSTLEDER (NICHT ABNEHMBAR). STANDARD FUSS aus poliertem Aluminium, h. 15 cm (Cod. PD10375). OPTIONALER FUSS aus lackiertem braunen Aluminium, h. 15 cm (Cod. PD10376).

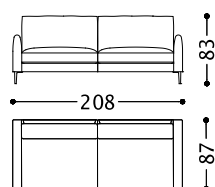

1VG2D3

DREI SITZER SOFA

1VG2D3		2VG2D3	
Cat.3	2.389,00	Cat.E	3.069,00
Cat.4	2.533,00	Cat.F	3.761,00
Cat.5	2.641,00	Cat.G	4.078,00
Cat.6	2.749,00	Cat.H	4.540,00
Cat.7	2.893,00	Cat.I	5.434,00
Cat.8	3.037,00	Cat.L	5.838,00
Cat.9	3.470,00	Cat.M	6.357,00
Cat.10	3.758,00		
Cat.11	4.082,00		
Cat.12	4.406,00		
Cat.13	4.803,00		

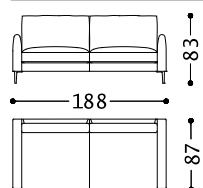

1VG2D2M

ZWEI SITZER MAXI SOFA

1VG2D2M		2VG2D2M	
Cat.3	2.145,00	Cat.E	2.735,00
Cat.4	2.289,00	Cat.F	3.374,00
Cat.5	2.398,00	Cat.G	3.667,00
Cat.6	2.506,00	Cat.H	4.093,00
Cat.7	2.650,00	Cat.I	4.918,00
Cat.8	2.794,00	Cat.L	5.291,00
Cat.9	3.226,00	Cat.M	5.770,00
Cat.10	3.515,00		
Cat.11	3.839,00		
Cat.12	4.163,00		
Cat.13	4.560,00		

VEGA 2

Wahrung: EUR

alberta
Made in Italy

07 S74 N/E D. ORANGE 03.2023

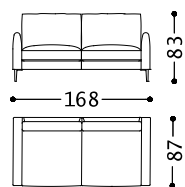



ZWEI SITZER SOFA

1VG2D2

1VG2D2		2VG2D2	
Cat.3	2.056,00	Cat.E	2.563,00
Cat.4	2.195,00	Cat.F	3.149,00
Cat.5	2.300,00	Cat.G	3.417,00
Cat.6	2.405,00	Cat.H	3.808,00
Cat.7	2.545,00	Cat.I	4.565,00
Cat.8	2.685,00	Cat.L	4.906,00
Cat.9	3.105,00	Cat.M	5.346,00
Cat.10	3.384,00		
Cat.11	3.699,00		
Cat.12	4.014,00		
Cat.13	4.398,00		

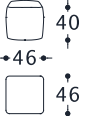
DIE STOFF-VERSION IST ABNEHMBAR. DIESES MODELL KANN NUR MIT EINEM EINZELNEN STOFF BEZOGEN WERDEN. GESTREIFTE, KARRIERTE STOFFE ODER STOFFE MIT MUSTERN EIGNEN SICH NICHT FÜR DIESES MODELL. LIEFERBAR AUCH AUS KUNSTLEDER (NICHT ABNEHMBAR).

 <p>POUFFMRB</p>	<p>QUADRATISCHER HOCKER 46x46 CM</p>	POUFFMRB		POUFFPMBP	
		Cat.3	208,00	Cat.E	330,00
		Cat.4	231,00	Cat.F	428,00
		Cat.5	248,00	Cat.G	472,00
		Cat.6	266,00	Cat.H	537,00
		Cat.7	289,00	Cat.I	664,00
		Cat.8	312,00	Cat.L	721,00
		Cat.9	381,00	Cat.M	794,00
		Cat.10	427,00		
		Cat.11	479,00		
		Cat.12	531,00		
		Cat.13	595,00		

 <p>POUFFMRB</p>	<p>RECHTECKIGER HOCKER 66x56 CM</p>	POUFFMRB		POUFFPMBP	
		Cat.3	265,00	Cat.E	419,00
		Cat.4	290,00	Cat.F	557,00
		Cat.5	308,00	Cat.G	620,00
		Cat.6	326,00	Cat.H	711,00
		Cat.7	351,00	Cat.I	889,00
		Cat.8	376,00	Cat.L	970,00
		Cat.9	449,00	Cat.M	1.073,00
		Cat.10	499,00		
		Cat.11	554,00		
		Cat.12	609,00		
		Cat.13	677,00		

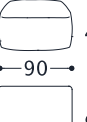
 <p>PFF90MRB</p>	<p>QUADRATISCHER HOCKER 90x90 CM</p>	PFF90MRB		PFF90PMBP	
		Cat.3	482,00	Cat.E	696,00
		Cat.4	526,00	Cat.F	949,00
		Cat.5	559,00	Cat.G	1.065,00
		Cat.6	592,00	Cat.H	1.233,00
		Cat.7	635,00	Cat.I	1.560,00
		Cat.8	679,00	Cat.L	1.708,00
		Cat.9	811,00	Cat.M	1.898,00
		Cat.10	899,00		
		Cat.11	998,00		
		Cat.12	1.097,00		
		Cat.13	1.218,00		

07 S74 N/E D. ORANGE 03.2023

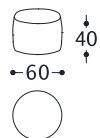

RUNDER HOCKER

1MRBPFFO

1MRBPFFO		2MBPFFO	
Cat.3	285,00	Cat.E	447,00
Cat.4	321,00	Cat.F	580,00
Cat.5	348,00	Cat.G	641,00
Cat.6	374,00	Cat.H	730,00
Cat.7	410,00	Cat.I	902,00
Cat.8	446,00	Cat.L	980,00
Cat.9	553,00	Cat.M	1.080,00
Cat.10	625,00		
Cat.11	705,00		
Cat.12	786,00		
Cat.13	884,00		

DIE STOFF-VERSION IST ABNEHMBAR. DIESES MODELL KANN NUR MIT EINEM EINZELNEN STOFF BEZOGEN WERDEN. GESTREIFTE STOFFE ODER STOFFE MIT MUSTERN EIGNEN SICH NUR FÜR KISSEN. MODELL AUS KUNSTLEDER NICHT VERFÜGBAR.

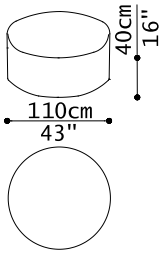

POUFFO99

RUNDER HOCKER Ø110 CM

POUFFO99		299PFFO	
Cat.3	697,00	Cat.E	821,00
Cat.4	737,00	Cat.F	978,00
Cat.5	767,00	Cat.G	1.051,00
Cat.6	796,00	Cat.H	1.156,00
Cat.7	836,00	Cat.I	1.359,00
Cat.8	876,00	Cat.L	1.451,00
Cat.9	995,00	Cat.M	1.569,00
Cat.10	1.075,00		
Cat.11	1.164,00		
Cat.12	1.254,00		
Cat.13	1.363,00		

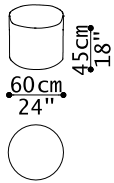

199POP

RUNDER KLEINER HOCKER

199POP		299POP	
Cat.3	370,00	Cat.E	442,00
Cat.4	394,00	Cat.F	532,00
Cat.5	413,00	Cat.G	573,00
Cat.6	431,00	Cat.H	632,00
Cat.7	455,00	Cat.I	748,00
Cat.8	479,00	Cat.L	800,00
Cat.9	551,00	Cat.M	867,00
Cat.10	600,00		
Cat.11	654,00		
Cat.12	708,00		
Cat.13	775,00		

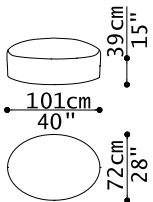

199PFFVG

GROSSER OVALER HOCKER

199PFFVG		299PFFVG	
Cat.3	634,00	Cat.E	723,00
Cat.4	670,00	Cat.F	851,00
Cat.5	696,00	Cat.G	909,00
Cat.6	723,00	Cat.H	994,00
Cat.7	759,00	Cat.I	1.159,00
Cat.8	794,00	Cat.L	1.234,00
Cat.9	901,00	Cat.M	1.330,00
Cat.10	972,00		
Cat.11	1.051,00		
Cat.12	1.131,00		
Cat.13	1.229,00		

07 S74 N/E D. ORANGE 03.2023

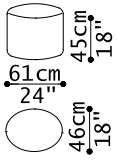

OVALER HOCKER 61X46 CM

POUFFOV99

POUFFOV99		299PFFV	
Cat.3	428,00	Cat.E	487,00
Cat.4	448,00	Cat.F	570,00
Cat.5	462,00	Cat.G	608,00
Cat.6	476,00	Cat.H	664,00
Cat.7	496,00	Cat.I	771,00
Cat.8	515,00	Cat.L	819,00
Cat.9	572,00	Cat.M	882,00
Cat.10	611,00		
Cat.11	654,00		
Cat.12	697,00		
Cat.13	750,00		

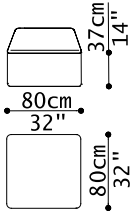

QUADRATISCHER HOCKER 80X80 CM

PFF8099

PFF8099		299PFFQ	
Cat.3	462,00	Cat.E	590,00
Cat.4	492,00	Cat.F	731,00
Cat.5	515,00	Cat.G	795,00
Cat.6	538,00	Cat.H	889,00
Cat.7	569,00	Cat.I	1.071,00
Cat.8	599,00	Cat.L	1.153,00
Cat.9	691,00	Cat.M	1.258,00
Cat.10	752,00		
Cat.11	821,00		
Cat.12	889,00		
Cat.13	973,00		

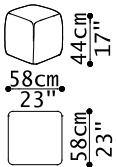

QUADRATISCHER GEWÖLSSTER HOCKER 58X58

POUFFQB99

POUFFQB99		299PFFB	
Cat.3	298,00	Cat.E	459,00
Cat.4	321,00	Cat.F	553,00
Cat.5	338,00	Cat.G	596,00
Cat.6	355,00	Cat.H	658,00
Cat.7	378,00	Cat.I	779,00
Cat.8	400,00	Cat.L	834,00
Cat.9	468,00	Cat.M	904,00
Cat.10	514,00		
Cat.11	565,00		
Cat.12	616,00		
Cat.13	679,00		

07 S74 N/E D. ORANGE 03.2023

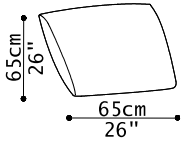

199CQ65

QUADRATISCHER KISSEN 65X65 CM

199CQ65		299CQ65	
Cat.3	115,00	Cat.E	180,00
Cat.4	128,00	Cat.F	251,00
Cat.5	137,00	Cat.G	283,00
Cat.6	147,00	Cat.H	330,00
Cat.7	160,00	Cat.I	421,00
Cat.8	173,00	Cat.L	462,00
Cat.9	211,00	Cat.M	514,00
Cat.10	236,00		
Cat.11	265,00		
Cat.12	294,00		
Cat.13	329,00		

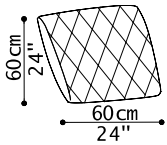

199CQ60T

GESTEPPT KISSEN AUS FEDER CM 60X60

199CQ60T		299CQ60T	
Cat.3	175,00	Cat.E	194,00
Cat.4	206,00	Cat.F	255,00
Cat.5	229,00	Cat.G	284,00
Cat.6	252,00	Cat.H	325,00
Cat.7	282,00	Cat.I	405,00
Cat.8	313,00	Cat.L	441,00
Cat.9	404,00	Cat.M	487,00
Cat.10	465,00		
Cat.11	534,00		
Cat.12	603,00		
Cat.13	687,00		

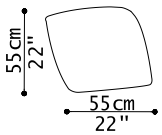

199CQ55P

QUADRATISCHER KISSEN AUS FEDER
55X55 CM

199CQ55P		299CQ55P	
Cat.3	97,00	Cat.E	130,00
Cat.4	108,00	Cat.F	173,00
Cat.5	117,00	Cat.G	192,00
Cat.6	125,00	Cat.H	221,00
Cat.7	137,00	Cat.I	276,00
Cat.8	148,00	Cat.L	301,00
Cat.9	182,00	Cat.M	332,00
Cat.10	205,00		
Cat.11	230,00		
Cat.12	256,00		
Cat.13	287,00		

07 S74 N/E D. ORANGE 03.2023

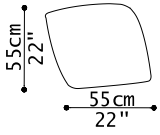

299CQ55PV

QUADRATISCHER KISSEN AUS FEDER
55X55 CM (ROHZUSCHNITT)

299CQ55PV	
Cat.E	130,00
Cat.F	173,00
Cat.G	192,00
Cat.H	221,00
Cat.I	276,00
Cat.L	301,00
Cat.M	332,00

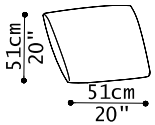

199CQ51P

QUADRATISCHER KISSEN AUS FEDER
51X51 CM

199CQ51P	
Cat.3	94,00
Cat.4	105,00
Cat.5	113,00
Cat.6	121,00
Cat.7	131,00
Cat.8	142,00
Cat.9	174,00
Cat.10	195,00
Cat.11	219,00
Cat.12	243,00
Cat.13	273,00

299CQ51P	
Cat.E	131,00
Cat.F	174,00
Cat.G	194,00
Cat.H	222,00
Cat.I	277,00
Cat.L	302,00
Cat.M	334,00

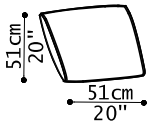

199CQ51GP

QUADRATISCHER KISSEN AUS FEDER MIT
GROSGRAIN CM 51X51

199CQ51GP	
Cat.3	98,00
Cat.4	108,00
Cat.5	116,00
Cat.6	124,00
Cat.7	135,00
Cat.8	145,00
Cat.9	177,00
Cat.10	199,00
Cat.11	223,00
Cat.12	247,00
Cat.13	276,00

299CQ51GP	
Cat.E	135,00
Cat.F	177,00
Cat.G	197,00
Cat.H	225,00
Cat.I	280,00
Cat.L	305,00
Cat.M	337,00

07 S74 N/E D. ORANGE 03.2023

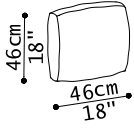

199CP

RUCKENKISSEN KLEINE

199CP		299CP	
Cat.3	77,00	Cat.E	132,00
Cat.4	88,00	Cat.F	191,00
Cat.5	96,00	Cat.G	218,00
Cat.6	104,00	Cat.H	258,00
Cat.7	115,00	Cat.I	334,00
Cat.8	125,00	Cat.L	369,00
Cat.9	157,00	Cat.M	413,00
Cat.10	179,00		
Cat.11	203,00		
Cat.12	227,00		
Cat.13	256,00		

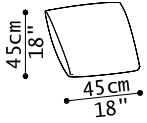

199CQ45

QUADRATISCHER KISSEN AUS FEDER
45X45 CM

199CQ45		299CQ45	
Cat.3	83,00	Cat.E	121,00
Cat.4	92,00	Cat.F	164,00
Cat.5	100,00	Cat.G	183,00
Cat.6	107,00	Cat.H	212,00
Cat.7	117,00	Cat.I	267,00
Cat.8	127,00	Cat.L	292,00
Cat.9	157,00	Cat.M	324,00
Cat.10	177,00		
Cat.11	199,00		
Cat.12	222,00		
Cat.13	249,00		

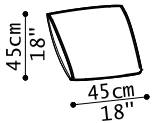

199CQ45G

QUADRATISCHER KISSEN AUS FEDER MIT
GROSGRAIN CM 45X45

199CQ45G		299CQ45G	
Cat.3	85,00	Cat.E	124,00
Cat.4	95,00	Cat.F	167,00
Cat.5	103,00	Cat.G	186,00
Cat.6	110,00	Cat.H	215,00
Cat.7	120,00	Cat.I	270,00
Cat.8	130,00	Cat.L	294,00
Cat.9	160,00	Cat.M	326,00
Cat.10	180,00		
Cat.11	202,00		
Cat.12	224,00		
Cat.13	252,00		

07 S74 N/E D. ORANGE 03.2023

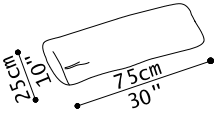

199PR

NIERENKISSEN

199PR		299PR	
Cat.3	99,00	Cat.E	118,00
Cat.4	114,00	Cat.F	152,00
Cat.5	124,00	Cat.G	168,00
Cat.6	135,00	Cat.H	190,00
Cat.7	149,00	Cat.I	234,00
Cat.8	163,00	Cat.L	254,00
Cat.9	206,00	Cat.M	280,00
Cat.10	234,00		
Cat.11	266,00		
Cat.12	298,00		
Cat.13	337,00		

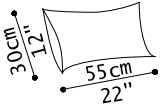

199PGB

NIERENKISSEN

199PGB		299PGB	
Cat.3	75,00	Cat.E	115,00
Cat.4	83,00	Cat.F	147,00
Cat.5	89,00	Cat.G	162,00
Cat.6	96,00	Cat.H	183,00
Cat.7	104,00	Cat.I	224,00
Cat.8	113,00	Cat.L	243,00
Cat.9	138,00	Cat.M	267,00
Cat.10	155,00		
Cat.11	175,00		
Cat.12	194,00		
Cat.13	217,00		

TS

STOFF H. 140 CM

TS	
Cat.3	48,00
Cat.4	72,00
Cat.5	90,00
Cat.6	108,00
Cat.7	132,00
Cat.8	156,00
Cat.9	209,00
Cat.10	253,00
Cat.11	302,00
Cat.12	352,00
Cat.13	412,00

PL

LEDER

PL	
Cat.E	105,00
Cat.F	143,00
Cat.G	171,00
Cat.H	217,00
Cat.I	275,00
Cat.L	310,00
Cat.M	355,00

LEDER

Sahara (Kat. E) Wertiges Rindsleder Narben, geschliffen auf einheitliche Stärke, im Fass gefärbt, mit einheitlicher Porenprägung „Dollaro Americano“. Mit wasserfester Endbehandlung.

Stärke 1.4 – 1.6mm.

Bob (Kat. F) Hochwertiges Rindsleder, korrigiertes Korn, pigmentiert Färbung, geschliffen auf einheitliche Stärke, Anilinleder fassgefärbt, mit einheitlicher Porenprägung „Dollaro Americano“. Mit wasserfester Endbehandlung.

Stärke 1.4 – 1.6mm.

Columbia (Kat. F) Wertiges Rindsleder Narben und Nubuk-Effekt Verarbeitung, Anilinleder fassgefärbt, fertig mit Wachsen und Paraffinen. **Das Leder muss nur mit Nubuckreinigungskit behandelt werden.**

Stärke 1.3 - 1.5 mm.

Dakota (Kat. F) Rindsleder Narben mit oberflächiger Retouchierung, im Fass gefärbt und mit Wasserfarben-Endbehandlung, mit leichter Prägung und charakteristischer Behandlung, die einen schönen Glanz geben.

Stärke 0.9 – 1.1 mm.

Ascott (Kat. G) Hochwertiges Rindsleder Narben, leicht retouchiert, im Fass gefärbt, mit glatter Oberfläche, mit wasserfester Endbehandlung.

Stärke 1,2 – 1.4 mm

Fjord (Kat. G) Hochwertiges Rindsleder Vollnarbig, im Fass gefärbt, Anilin mit natürlicher Charakteristik. Ein Leder mit hohem Wert und Qualität. Mit natürlicher, unregelmässiger Porung (mal grösser, mal kleiner), was den Wert und keinen Defekt darstellt.

Stärke 1.3 – 1.5mm.

Windsor (Kat. H) Hochwertiges Rindsleder Narben, leicht retouchiert, im Fass gefärbt, mit glatter Oberfläche, mit wasserfester Endbehandlung.

Stärke 1,2 – 1.4 mm

President (Kat.H) Rindsleder Vollnarbig, im Fass gefärbt, Anilin-Feinbearbeitung, natürlicher Porung mit hoher Stärke mit einem alten und matten Effekt gekennzeichnet. Die natürliche Porung ist nicht einheitlich (mal grösser, mal kleiner) Die natürliche unregelmässige Porung ist ein Wert und kein Defekt.

Stärke 1.3 – 1.5 mm.

Sensation (Kat. H) Europäische Rindsleder, Nubuk Verarbeitung, Chromgegerbt, Anilin Feinbearbeitung. Die spezielle Nubuk Verarbeitung verstärkt die Exklusivität noch mehr. Geschlossenen Mängel, Falten und Kratzer sind typische Merkmale eines natürlichen Artikels, die seine Originalität hervorheben. Durch eine Behandlung vor der Nubuk Bearbeitung, durch ein langes Handhausgeführtes Schleifen fühlt sich das Leder Sensation weich und wie samtig an. **Das Leder muss nur mit Nubuckreinigungskit behandelt werden.**

Stärke: 1.3 - 1.5 mm.

Tender (Kat. H) Rindleder mit Farbstoffen aus reinem Anilin im Fass gefärbt und fein bearbeitet. Das Lederhautaeussere praesentiert einen leicht nachgebesserten natuerlichen Narben mit Nabukbearbeitung, die dessen Exklusivitaet hervorhebt sowie sich besonders weich und samtig anfühlt. Das Leder der "Tender" Kollektion wird durch Handschmiegeln mit einem aufhellenden, matten, wasserabstossenden Effekt feinbearbeitet. Geschlossene Defekte, Farbtonveraenderungen, Narben und Kratzer zeigen: Das sind typische Eigenarten eines so originellen Artikels. **Dieses Leder muss nur mit Nubukkit gereinigt und behandelt werden.**

Stärke: 1.3 - 1.5 mm.

Coral (Kat. I) Coral Leder verkörpert die Essenz von Naturleder. Dank der Anilinverarbeitung mit hochwertigen Wachsen hat es ein einzigartiges Aussehen, das durch glänzende Reflexionen beim Bewegen gekennzeichnet ist. Diese Verarbeitung verleiht dem Leder eine außergewöhnliche Weichheit in der Haptik, die das Markenzeichen der besten Aniline auf dem Markt darstellt. Zusammenfassend ist Coral ein Lederprodukt von höchster Qualität, das durch seine Natürlichkeit und Leuchtkraft Aufmerksamkeit erregt. **Das Leder muss nur mit Nubukreinigungskit behandelt werden.**

Stärke: 1.2 - 1.4 mm.

Nabuk (Kat. I) Antiflecken-Rindsleder Vollnarbig, Nubuk-Verarbeitung, im Fass gefärbt mit Anilinfarben, mit aussergewöhnlicher Samtweichheit und Naturwärme. Die Scotchgard Protector-Behandlung garantiert Wasserrückabstossung und Schmutzwiderstand. Geschlossene Mängel, Farbtonänderungen, Falten und Kratzer sind tipische Merkmale eines natürlichen Artikels, die seine Originalität hervorheben. **Das Leder muss nur mit Nubukreinigungskit behandelt werden.**

Stärke 1.2 – 1.4 mm.

Bamboo (Kat. L) Antiflecken-Rindsleder Vollnarbig, Nubuk-Verarbeitung, im Fass gefärbt mit Anilinfarben, mit aussergewöhnlicher Samtweichheit und Naturwärme; von einem originellen Flechtdruck verziert. Die Scotchgard Protector-Behandlung garantiert Wasserrückabstossung und Schmutzwiderstand. Geschlossene Mängel, Farbtonänderungen, Falten und Kratzer sind tipische Merkmale eines natürlichen Artikels, die seine Originalität hervorheben. **Das Leder muss nur mit Nubukreinigungskit behandelt werden.**

Stärke 1.2 – 1.4 mm.

Raji (Kat. M) Antiflecken-Rindsleder Vollnarbig, Nubuk-Verarbeitung, im Fass gefärbt mit Anilinfarben, mit aussergewöhnlicher Samtweichheit und Naturwärme. Die Scotchgard Protector-Behandlung garantiert Wasserrückabstossung und Schmutzwiderstand. Das Leder wird weiter mit Paliletten nach der traditinellen Schneiderweise verziert. Geschlossene Mängel, Farbtonänderungen, Falten und Kratzer sind tipische Merkmale eines natürlichen Artikels, die seine Originalität hervorheben. **Das Leder muss nur mit Nubukreinigungskit behandelt werden.**

Stärke 1.2 – 1.4 mm.

Gerbung, Fattung, Färbung und Zurichtung entsprechen den UE-Richtlinien und werden im Sinne des biochemischen Gleichgewichts der Umwelt durchgeführt.

alberta

Alberta Pacific Furniture Spa
via Toniolo, 41 - 31028 Vazzola (TV) - ITALY
Tel. (0039) 0438 440440 - Fax (0039) 0438 441555
export@alberta.it
www.alberta.it